



# MB32 Moisture Analyzer Instruction Manual





# Version History

Date	Version	Description
2024/6/10	A	• Initial Release
2024/9/11	B	• Add instructions of working with Bluetooth Printer SF40A/BT

# Contents

<b>1. Introduction.....</b>	<b>1</b>
1.1. Overview of the Moisture Analyzer.....	1
1.2. What is a Carbon Fiber Moisture Analyzer?.....	1
<b>2. Safety Information.....</b>	<b>3</b>
<b>3. Installation and Initial Setup.....</b>	<b>7</b>
3.1. Unpacking.....	7
3.2. Select the Location.....	7
3.3. Assemble the Instrument.....	8
3.4. Levelling Your Moisture Analyzer.....	8
3.5. Connecting to a Power Supply.....	9
3.6. Switch On or Off the Unit.....	9
<b>4. Structure and Functions.....</b>	<b>11</b>
4.1. MB32 Product Structure.....	11
4.2. MB32 Control Panel.....	12
4.3. MB32 Displays.....	13
4.4. Drying Program Segment Definition.....	14
<b>5. Operation.....</b>	<b>16</b>
5.1. Make a Measurement.....	17
5.1.1. Good Practices of Sample Preparation.....	18
5.1.2. Steps to Make a Measurement.....	22
5.2. Configure the Methods.....	24
5.2.1. Method Parameters.....	24
5.2.2. User Operations.....	27
5.3. Weight and Temperature Adjustment.....	29
5.3.1. Weight Adjustment.....	29
5.3.2. Temperature Adjustment.....	30
5.4. Print Management.....	32
5.4.1. Configure Print Parameters.....	32
5.4.2. Auto Printing.....	32
5.4.3. Print Contents.....	32
5.4.4. Connect to a Printer.....	34
<b>6. Settings.....</b>	<b>36</b>
6.1. Enter the Settings.....	36
6.2. Sub Menus.....	36



- 6.2.1. Adjustment ..... 36
- 6.2.2. General..... 36
- 6.2.3. Communication..... 37
- 6.2.4. GLP/GMP Data..... 41
- 6.2.5. System and Data..... 41
- 6.2.6. Reset..... 42
- 6.2.7. Instrument info..... 42
- 7. Accessory..... 43**
- 8. Maintenance..... 44**
  - 8.1. Cleaning..... 44
  - 8.2. Replacing Power Line Fuse..... 44
  - 8.3. Troubleshoot..... 45
  - 8.4. Technical Support Information..... 45
- 9. Technical Data..... 46**
- 10. User Commands..... 48**
- 11. Compliance..... 49**
  - 11.1. FCC Supplier Declaration of Conformity..... 49
- 12. Limited Warranty..... 51**



# 1. Introduction

Thank you for deciding to purchase Ohaus Carbon Fiber Moisture Analyzer. Behind your instrument stands OHAUS, a leading manufacturer of precision Moisture Analyzers, Balances, Scales and Indicators. An Aftermarket Department with trained instrument technicians is dedicated to provide you with the fastest service possible in the event your instrument requires servicing. OHAUS also has a Customer Service Department to answer any inquiries regarding applications and accessories.

To ensure you make full use of the possibilities offered by your Moisture Analyzer, please read the manual completely before installation and operation.

## 1.1. Overview of the Moisture Analyzer

The Moisture Analyzer offers a high level of operating convenience and useful functions to make accurate measurements.

- Extremely rugged and chemically resistant construction.
- Ergonomic operating controls and a large, easily readable display.
- Easy to follow menus for simplified operation.
- Built-in functions for manual, automatic timing, printing intervals.
- Built-in selectable drying profiles.
- Built-in library that stores method data
- Built-in RS232 and USB interface.
- Any of the eleven languages (English, Spanish, French, German, Italian, Polish, Portuguese, Chinese, Japanese, Korean, Turkish)
- Display contains all test data during drying process.
- A variety of optional accessories includes disposable pan liners, temperature calibration kit, interface communication cables, and printer.

## 1.2. What is a Carbon Fiber Moisture Analyzer?

The Ohaus Carbon Fiber Moisture Analyzer can be used to determine the moisture content of practically any substance. The instrument operates on the thermo-gravimetric principle: At the start of the measurement, the Moisture Analyzer determines the weight of the sample; the sample is then quickly heated by the integral carbon fiber dryer unit and moisture vaporizes. During the drying operation, the instrument continuously determines the weight of the sample and displays the result. On completion of drying, result is displayed as % moisture content, % solids, weight or % regain.

Of particular importance in practice is the rate of heating. In comparison with conventional infrared heating or the drying oven method, for example, the carbon fiber dryer of your instrument needs a shorter time to reach its maximum heating power. It also allows the use of high temperatures; an additional factor in shortening the drying time. Response times for the control of production are shorter resulting in increased productivity.

All parameters of a measurement (drying temperature, drying time, etc.) can be pre-selected. The Moisture Analyzer offers many other possibilities. A few of these are listed here:

- The integrated database for drying procedures stores the settings for your samples.
- The drying characteristics can be matched to the type of sample.
- Your settings and measurement results can be recorded and stored.
- Built-in battery backup stores valuable data during a power failure.

Even though the Moisture Analyzer contains many functions, operation remains simple:

- The four button controls on the front panel for frequently used functions: Power on/off, Print, Start/Stop and Tare.
- The rotation knob offers easy entry into variety of menus and libraries for the Settings menu, and a method library.

The libraries store data so that a similar sample can be run without the need to enter all new data.

- Test progress and parameters are displayed on screen, including method name, target temperature, actual temperature, switch-off criteria, time, measurements (moisture content in percent, solids in percent, grams, % regain) and a graphical display which illustrates the time and percentage.

Your Moisture Analyzer conforms with all common standards and directives. It supports standard procedures, work techniques and records as required by SOP (Standard Operating Procedure). We recommend the use of the OHAUS SF40A or OHAUS SF40A/ BT Printer for optimal printing performances.

## 2. Safety Information

### Definition of Signal Warnings and Symbols

- WARNING** For a hazardous situation with medium risk, possibly resulting in severe injuries or death if not avoided.
- CAUTION** For a hazardous situation with low risk, resulting in damage to the device or the property or in loss of data, or minor or medium injuries if not avoided.
- Attention** For important information about the product. May lead to equipment damage if not avoided.
- Note** For useful information about the product.



General hazard



Explosion Hazard



Electrical shock



Caution, hot surface



Alternating Current



Fire or explosion



Warning Poisoning



Warning corrosion



Fuse

For parameters, please refer to [Technical Data](#) (on page 46)



Protective earth (ground)

### General Safety Information

Your instrument meets the state of the art technology and complies with all recognized safety rules, however, certain hazards may arise in extraneous circumstances. Do not open the housing of the instrument: It does not contain any parts which can be maintained, repaired or replaced by the user. If you ever have problems with your instrument, contact your authorized OHAUS dealer or service representative.

Always operate and use your instrument only in accordance with the instructions contained in this manual. The instructions for setting up your new instrument must be strictly observed.

If the instrument is not used according to these Operating Instructions, protection of the instrument may be impaired and OHAUS assumes no liability.

## Staff Safety

The Moisture Analyzer may be operated only by trained personnel who are familiar with the properties of the samples used and with the handling of the instrument. In order to use the instrument, you must have read and understood the operating instructions. Keep the operating instructions for further reference.



### CAUTION:

Never make any modifications to the instrument and use only original spare parts and optional equipment from OHAUS.

## Protective Clothing

It is advisable to wear protective clothing in the laboratory when working with the instrument.



A lab coat should be worn.



A suitable eye protection such as goggles should be worn.



Use appropriate gloves when handling chemicals or hazardous substances, checking their integrity before use.

## Safety Precautions



**CAUTION:** Read all safety warnings before installing, making connections, or servicing this equipment. Failure to comply with these warnings could result in personal injury and/or property damage. Retain all instructions for future reference.

- Before connecting power, verify that the product or its AC adapter input voltage range and plug type are compatible with the local AC mains power supply.
- Do not position the equipment such that it is difficult to reach the power connection.
- Only connect the power cord to a compatible grounded electrical outlet.
- Only use a power cord with a rating that exceeds the specifications on the equipment label.
- Make sure that the power cord does not pose a potential obstacle or tripping hazard.
- Operate the equipment only under ambient conditions specified in the user instructions.
- This equipment is for indoor use only.
- Do not operate the equipment in wet, hazardous or unstable environments.
- Do not allow liquids to enter the equipment.
- Do not place the equipment upside down on the platform.
- Use only approved accessories and peripherals.
- Disconnect the equipment from mains power before cleaning or servicing.
- Service should only be performed by authorized personnel.



**WARNING:** Never work in an environment subject to explosion hazards! The housing of the instrument is not gas tight. (explosion hazard due to spark formation, corrosion caused by the ingress of gases)



**WARNING:** Electrical shock hazards exist within the housing. The housing should only be opened by authorized and qualified personnel. Remove all power connections to the unit before opening.



**WARNING!** Substances contain toxic or caustic components  
Toxic gases produced during drying could cause irritations (eyes, Skin, breathing), illness or death.

- Such substances may be dried only in a fume cupboard.

**CAUTION!** Corrosion!



Substances evolve corrosive vapors when heated (e.g. acids).

- Work with small amounts of samples as the vapor can condense on cooler housing parts and cause corrosion.

**CAUTION!** The Moisture Analyzer works with heat!

- Ensure sufficient free space around the instrument to avoid heat accumulation and overheating (approx. 1 m free space above the heating module).
- The vent over the sample must never be covered, plugged, taped over or tampered with in any other way.
- Do not place any combustible materials on, under or next to the instrument since the area around the heating module may be hot.
- Exercise caution when removing the sample. The sample itself, the sample chamber, the draft shield and any sample vessels used may still be very hot.
- During operation, you should never open the heating module itself as the ring-shaped heating reflector or its protective glass can reach 400 °C! If you have to open the heating module e.g. for maintenance, disconnect the instrument from the power supply and wait until the heating module has cooled down completely.
- No modifications must be made within the heating module. It is particularly dangerous to bend any components or remove them or to make any other changes.



**CAUTION!** Fire or Explosion

- Flammable or explosive substances.
- Substances containing solvents.
- Substances which evolve flammable or explosive gases or vapors when heated.



- In cases of doubt, perform a careful risk analysis.
- Work at a drying temperature that is low enough to prevent the formation of flames or an explosion.
- Wear protective goggles.
- Work with small amounts of sample.
- Never leave the instrument unattended!



It is not permitted to use the instrument in explosive atmosphere of gases, steam, fog, dust and flammable dust (hazardous environments).

## Intended Use

This instrument is intended for use in laboratories, pharmacies, schools, businesses and light industry. It must only be used for measuring the parameters described in these operating instructions. Any other type of use and operation beyond the limits of technical specifications, without written consent from OHAUS, is considered as not intended.

This instrument complies with current industry standards and the recognized safety regulations; however, it can constitute a hazard in use.

If the instrument is not used according to these operating instructions, the intended protection provided by the instrument may be impaired.



## 3. Installation and Initial Setup

This section introduces the unpacking, installation and initial setup instructions of preparing the Moisture Analyzer for operation.

### 3.1. Unpacking

Unpack the instrument and the accessories. Check the completeness of the delivery.

The following accessories are part of the standard equipment of your new Moisture Analyzer.

- 1 x Box, Aluminum sample pans
- 1 x Pan Holder
- 5 x Glass Fiber Pad
- 1 x Tray Pan
- 1 x Power Cable
- 1 x Pan Handle
- 1 x Quick Guide

Remove packing material from the instrument.

Check the instrument for transport damage. Immediately inform your Ohaus dealer if you have complaints or parts are missing.

Store all parts of the packaging. This packaging guarantees the best possible protection for the transport of your instrument.

### 3.2. Select the Location

The location must be sturdy, flat and level. Avoid locations with excessive air current, vibrations, heat sources or rapid temperature changes. Allow sufficient space around the instrument.

DO NOT install the Moisture Analyzer:

- Next to open windows or doors causing drafts or rapid temperature changes.
- Near air conditioning or heat vents.
- Near vibrating, rotating or reciprocating equipment.
- Near magnetic fields or equipment that generate magnetic fields.
- On an unlevel work surface.
- In confined areas, allow sufficient space around the instrument for ease of operation and keep away from radiating heat sources.

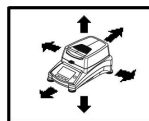
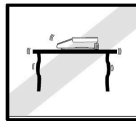

### 3.3. Assemble the Instrument

1. Lift the cover straight up and Install the Tray Pan (A) in the base of the heating chamber.
  2. Install the Pan Holder (C) into position. Turn the Pan Holder until it engages. In the locked position, the arm of the Pan Holder points directly towards the Heating Unit (E).
  3. Place the Sample Pan (D) onto the Pan Holder using the Pan Handler (B).
- The Pan Handler is integrated with draft shield for optimal measuring performance.

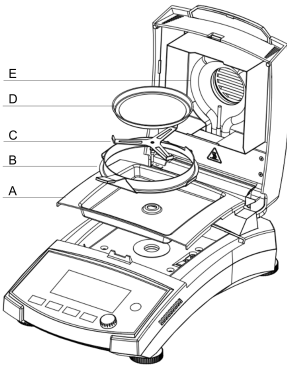

### 3.4. Levelling Your Moisture Analyzer

To achieve accurate measurement results, the moisture analyzer should be levelled to exact horizontal position. The moisture analyzer has a level indicator for showing the level status.

When the water bubble is not centered in the inner circle of the indicator, the moisture analyzer should be leveled to the exact horizontal position.

- If the water bubble is positioned at top: rotate the two lower wheel feet clockwise.
- If the water bubble is positioned at bottom: rotate the two upper wheel feet counter-clockwise.
- If the water bubble is positioned at right: rotate the upper-left wheel feet clockwise, and the lower-left wheel feet counter-clockwise.
- If the water bubble is positioned at left: rotate the upper-right wheel feet clockwise, and the lower-right wheel feet counter-clockwise.

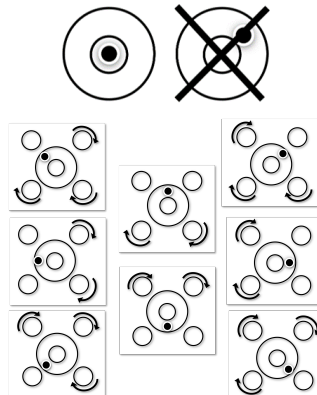

## 3.5. Connecting to a Power Supply



Warning! Risk of Electric Shock

- Use only the 3-pin power cord with equipment grounding connector which was supplied with your instrument. Only connect the power cord to a 3-pin ground outlet.
- Only extension cords which meet the relevant standards and also have an equipment grounding conductor may be used.

### ! Attention:

- Before connecting power, verify that the product or its AC adapter input voltage range and plug type are compatible with the local AC mains power supply.
- The dryer unit is designed to operate at a specific line voltage (110V AC or 240V AC). The dryer unit is installed at the factory and is matched to the particular line voltage of the country of destination.
- Connection to a line voltage that is too high can lead to burning out the heater, whereas, a supply voltage that is too low will prolong the drying process and the instrument may not operate properly.

## Connect to Power

Connect the power cord to the power supply socket located at the rear of the Moisture Analyzer and to the power supply outlet. The Moisture Analyzer becomes operational as soon as power is applied. The display will remain off until the On/Off button is pressed.



### 🔧 Note:

Place the Moisture Analyzer in the room where it will be used for at least 4 hours to adapt itself to ambient conditions. Turn on the moisture analyzer for at least 30 mins to warm up.

### ! Attention:

If the power cable supplied is not long enough, use only a proper 3-pin extension cable with an equipment grounding connector.

## 3.6. Switch On or Off the Unit

### Switch On the Unit

After the power is connected, short press  to switch on the unit.

## Switch Off the Unit

Long press   to switch off the unit.

## 4. Structure and Functions

### 4.1. MB32 Product Structure

#### Exterior Structure

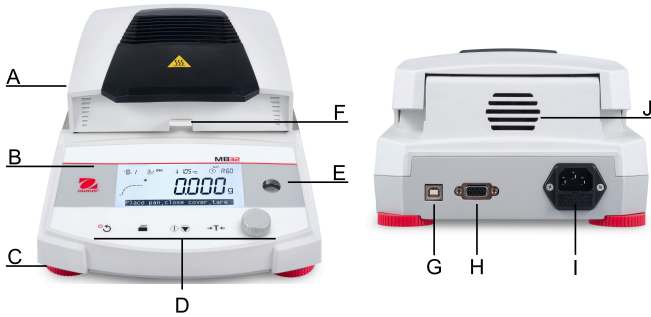

#	Structure	#	Structure
A	Top cover	B	Screen
C	Levelling feet	D	Controls
E	Levelling indicator	F	Sample pan handler with draft shield
G	USB Type B interface	H	RS232 Interface
I	Power supply connection and Power line fuse	J	Fan

#### Interior Structure

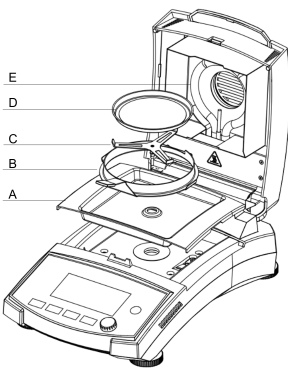

#	Description
A	Tray Pan
B	Pan Handler with Draft Shield
C	Pan Holder
D	Sample Pan
E	Heating Unit

## 4.2. MB32 Control Panel

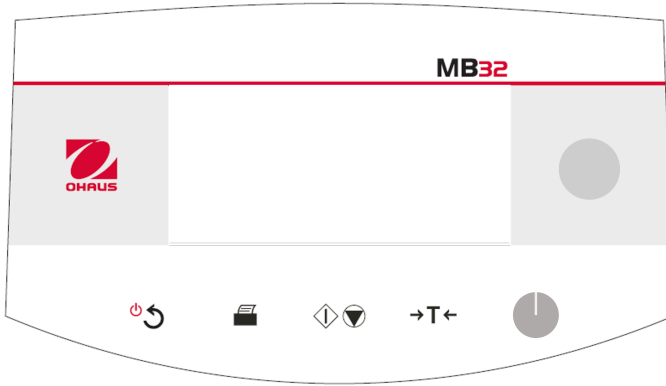

### Button functions

Button	Functions in general		Functions in Menu	Functions during the drying process
	Short press	Long press	Short press	Short press
	<ul style="list-style-type: none"> <li>Turn on the Moisture Analyzer.</li> <li>Back to the previous navigation.</li> </ul>	Turn off the Moisture Analyzer.	Return to the previous menu.	--
	Print measure or adjustment results.	--	--	--
	Start drying and analyzing.	--	--	Abort drying.
	In <b>Home screen</b> : Tare	--	Return to the <b>Home screen</b> .	--

### Rotation knob Functions

Action	Functions In Home screen	Functions in MENU	Functions during and after the drying process
Rotate	Enter the <b>Method</b> menu.	Navigate through the options.	Switch the displayed unit among %MC, %DC, g.
Short press	--	Confirm a selection.	--

Action	Functions In Home screen	Functions in MENU	Functions during and after the drying process
Long press	Enter the menu to select a function: <b>Sample ID, Result, Login, Method, Setting.</b>	--	--

### 4.3. MB32 Displays

#### Screen Display

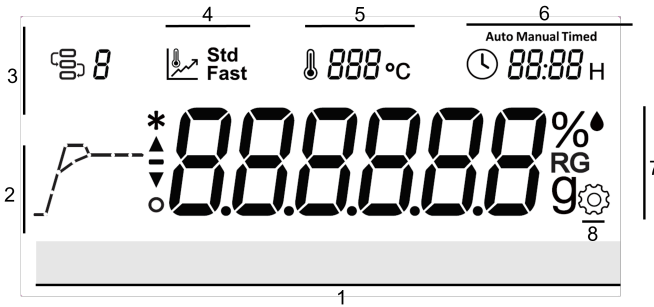

#	Field Name	#	Field Name
1	Instructional Messages	2	Progress Indicator
3	Method	4	Drying program
5	Temperature	6	Switch-off Criteria
7	Main Display field	8	Settings

#### Icon Definition

Icon	Definition	Icon	Definition
	Method		Switch-off criterion
	Drying Program		Moisture content in precentage
	Regain content in precentage		dry content in precentage
	Dry weight in gram		Stable weight
	Setting		Temperature

## 4.4. Drying Program Segment Definition

### Standard

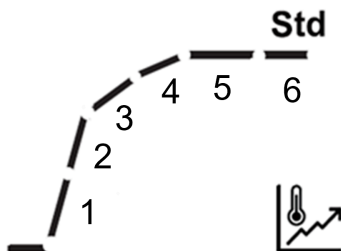

SOC	1	2	3	4	5	6
Auto	Heating from 20 °C to the target temperature. Each segments represents an equal division of the heating temperature.				Till weight loss is 1 mg per half of SOC time	Till auto-off criterion is reached
Example Auto (A60) 180 °C	Room temperature – 60 °C	60- 00 °C	100-140 °C	140-180 °C	Till A30 is reached	Till A60 is reached
Timed	Heating from 20 °C to the target temperature. Each segments represents an equal division of the heating temperature.				Till ¼ of time	Till the total time is reached
Example 10 min	Room temperature – 60 °C	60- 00 °C	100-140 °C	140-180 °C	After reached 180 °C, time 7.5 min	7.5 min - Completed
Manual	Heating from 20 °C to the target temperature. Each segments represents an equal division of the heating temperature.				Till the target temperature is reached	



# Fast

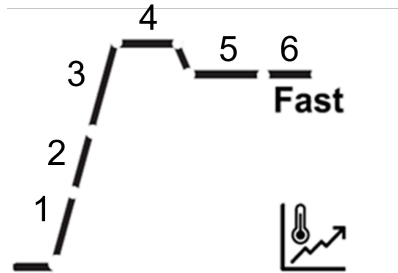

SOC	1	2	3	4	5	6	7
Auto	Heating from 20 °C to the overshoot temperature. Each segments represents an equal division of the heating temperature.			Stabling at the overshoot temperature	Cooling down to the target temperature	Till weight loss is 1 mg per half of SOC time	Till auto-off criterion is reached
Example Auto (A60) 180 °C	Room temperature – 97 °C	97-174 °C	174-200 °C	200 °C	200-180 °C	Till A30 is reached	Till A60 is reached
Timed	Heating from 20 °C to the target temperature. Each segments represents an equal division of the heating temperature.			Stabling at the overshoot temperature	Cooling down to the target temperature	Till ¼ of time	Till the total time is reached
Example 10 min	Room temperature – 97 °C	97-174 °C	174-200 °C	200 °C	200-180 °C	After reached 180 °C, time 7.5 min	7.5 min - Completed
Manual	Heating from 20 °C to the target temperature. Each segments represents an equal division of the heating temperature.			Stabling at the overshoot temperature	Cooling down to the target temperature	Till the target temperature is reached	



**Note:**

Standard overshoot temperature is 40% of the target temperature, maximum 200 °C.

## 5. Operation

This section provides guidances for users to work with their moisture analyzer smoothly. The section covers various aspects of the operation, including performing a measurement, adjusting weight and temperature, and managing methods, results and sample ID.

<b>Actions</b>	<b>Refer to</b>
<b>Make a Measurement</b>	<a href="#">Make a Measurement (on page 17)</a>
<b>Weight and Temperature Adjustment</b>	<a href="#">Weight and Temperature Adjustment (on page 29)</a>
<b>Method</b>	<a href="#">Configure the Methods (on page 24)</a>
<b>Print Management</b>	<a href="#">Print Management (on page 32)</a>

## 5.1. Make a Measurement

OHAUS MB32 has defined a standard testing procedure to ensure the measurement is performed safely and accurately. The moisture analyzer will instruct the user to follow the procedure:

Tare with empty sample pan > Place sample > Start Testing

### Topics

<a href="#">Good Practices of Sample Preparation <i>(on page 18)</i></a>
<a href="#">Steps to Make a Measurement <i>(on page 22)</i></a>

### **5.1.1. Good Practices of Sample Preparation**

Characteristics, preparation and size of the sample are all important contributing factors in increasing speed and the quality of the measurement process. Sampling and the sample preparation have a great influence on the reproducibility of the measured results. It is also important that the sample being investigated is a representative part of the total amount of the sample under test.

The final results of a moisture determination depends on a carefully thought out sample preparation. The part of the sample used for analysis must always be representative of the total quantity. The sample preparation includes work processes such as sampling, sample division, size reduction, homogenization and others. All of these processes should be carried out as quickly as possible and without loss or uptake of moisture.

As with most products, the lab samples are not homogenous. As a result, random sampling will not lead to a representative sample. The appropriate standards and directions must be consulted to determine the method of sampling as this is dependent upon the product, consistency and the amount used.

#### **Number of samples**

An increase in the number of samples always leads to an improvement in the statistical reliability of the analysis results. The size depends on the homogeneity of the test material, the accuracy of the test material, the accuracy of the measurement method and the desired accuracy of the measurement result.

#### **Mechanical size reduction**

Sample division is usually accomplished by specific types of mills influenced by the sample characteristics. Hard, brittle samples are mainly reduced in size by pressure, impact or friction action, whereas, soft and viscoplastic substances can be comminuted only by shearing or cutting action. Whatever the operating principle of a mill may be, for the subsequent moisture determination, there must be no loss of moisture during the milling operation. If this cannot be avoided, it should at least be calculable. The quantitative recovery of the mill chamber should also be simple and complete.

#### **Use of quartz sand**

To ensure an optimum drying process, samples should always have as large an area as possible. Results of substances which form crusts (e.g. glucose syrup) or pasty substances (e.g. butter) can be considerably improved by mixing with quartz sand. Sample pans with a large volume and relatively high walls are needed for this.

#### **Pasty, fat-containing and melting substances**

For pasty, fat containing and melting substances, use of a glass fiber filter is advantageous to increase the surface area of the sample. The glass fiber filter is tared together with the sample pan. The liquid contained in the substance is uniformly and extensively distributed in the interstices between the fibers throughout the available area. The same also applies to melting fats and fat containing samples. This increase in the surface area results in faster and complete vaporization of the moisture. Pre-drying of the glass fiber filter and storage in a desiccator is necessary only for highly precise measurement results.

## Liquid substances

Liquid substances (e.g. dispersions) often tend to form drops on the sample pan owing to the surface tension of the liquid. This prevents a rapid drying process. The use of a commercial glass fiber filter shortens the drying time by a factor of 2 to 3. The glass fiber filter distributes the liquid sample over a wide area as a result of its absorbent action. Pre-drying of the glass fiber filter and storage in a desiccator is necessary only for highly precise measurement results.

## Skin-forming and temperature sensitive substances

The use of a glass fiber filter can be useful for temperature-sensitive and skin forming substances. In this case, the sample to be dried is covered by the filter and thus receives a “new surface”. This shields the surface of the sample against direct IR radiation. Gentler heating of the samples is based on convection rather than on IR radiation. Experience with this type of preparation has been good; particularly for products containing sugar. Further, the shielding of the sample against direct IR radiation by covering the test substance can make a considerable contribution to improving the reproducibility with temperature sensitive samples.

## Sugar-containing substances

Samples containing a large amount of sugar tend to caramelize on the surface. In such cases, ensure a thin layer is applied. Also select a moderate temperature.

## Sample Distribution on the drying pan

To obtain reproducible results, it is essential to ensure uniform distribution of the sample on the pan. An uneven distribution can result in homogeneous heat distribution in the sample. As a result, the sample could be incompletely dried in the center owing to excessive piling. Thick layers have an adverse effect on the escape of moisture. The resulting lengthening of the measurement time promotes decomposition at the surface of the sample by prolonged heat action.

Film formation on the sample can prevent complete escape of the moisture. With such samples, ensure application of a thin and uniform layer thickness.

With readily volatile samples, rapid application of the sample on the sample pan is advisable, otherwise, moisture can escape before the initial weight is recorded; here, use of the manual operating mode is appropriate.

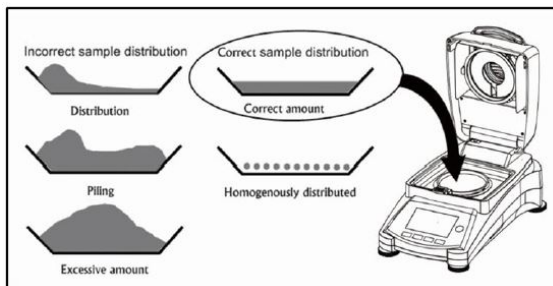

## Treating the sample during drying

Occasionally, following recording of the initial weight of the sample and before the actual drying, the test substance is subjected to further treatment. The Moisture Analyzer from OHAUS offers this possibility in the "manual" operating mode.

Such applications could include:

- Mixing of quartz sand: moisture which vaporizes during the mixing of the sample is correctly taken into account in the final result.
- Coagulation of protein by dropwise addition of alcoholic solutions. This prevents skin formation during drying. Added solvent is not recorded in the final result.
- Formation of readily volatile azeotropes by addition of solvents insoluble in water (e.g. xylene, toluene).

### ⚠ CAUTION:

Risk of Fire or Explosion! Addition of solvents can lead to the formation of flammable or even explosive mixtures. With applications of this type, you should thus work with extremely small amounts of samples and with the necessary care. In cases of doubt, a careful risk analysis must be performed.

## Selection of the optimum sample weight

The sample weight has an influence on both the accuracy of the measurement results and the measurement time. With large amounts of samples, a great deal of water must vaporize and the moisture determination takes longer.

To keep the measurement time as short as possible, we advise you choose a low weight for your sample, but not so low that attainment of the required measurement accuracy is no longer possible.

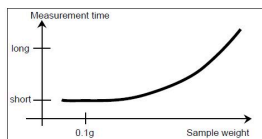
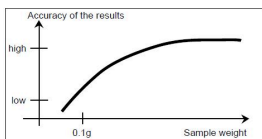

## Influence of the sample weight on the repeatability of the results

Sample weight influences the repeatability of the Moisture Analyzer. The repeatability always becomes worse with decreasing sample weight. The relation between sample weight and repeatability is shown in the following table:

Sample Weight	Repeatability
3g	±0.15%
10g	±0.02%

The preceding table is based on the assumption that the sample is ideal, homogeneous and its moisture can always be separated completely and free from decomposition (e.g. moist sand). Deviations always comprise the uncertainty, which depends on the sample,

---

and the repeatability of the instrument. In practice, measurement differences appearing within a measurement series can consequently be larger than the values of the Moisture Analyzer shown in the table.

## 5.1.2. Steps to Make a Measurement



### Prerequisites

- The correct **Method** is configured and loaded (refer to [Create a new Method \(on page 27\)](#) and [Load a Method \(on page 27\)](#).)

### Measurement Procedures

1. Place an empty sample pan on the pan holder, then close the cover and press

→T←

2. Add samples onto the sample pan, then close the cover and press the   to launch drying.

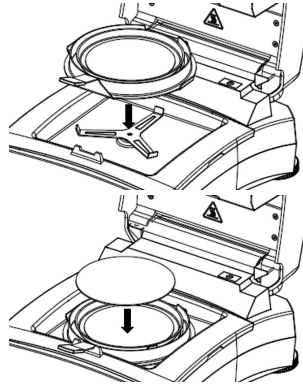

#### Note:

The minimum sample weight requirement is 0.5g. Drying cannot be started if the sample has not reach the minimum weight.

The screen will display the following testing informations:

- Result readings that can be displayed in %MC, %DC, %RG, and g.



#### Note:

Users can rotate the **Rotation knob** to switch the display mode.

- The method ID and the drying program which are used in this test.
  - The current temperature of heating chamber.
  - The time duration of the test.
3. When the test is completed, and the screen will display **Drying over, press tare**. After the test is completed, users can:
    - Read the final result from the screen. Rotate the **Rotation knob** to switch the display mode.
    - Press →T← to return to the Home screen.



4. Remove the sample pan by holding the Pan Handle.

 **CAUTION:**

The sample and the sample pan may still be hot! Hold the Pan Handle to remove the sample pan.

 **CAUTION:**

Precaution Heat!



will illuminate when the heating chamber temperature exceeds 60 °C.

## 5.2. Configure the Methods

**Method** refers to the specific procedure and parameters used in a test for determining the moisture content of a sample. In MB32, users can create up-to 2 methods.

### Related information

[Method Parameters \(on page 24\)](#)

[User Operations \(on page 27\)](#)

### 5.2.1. Method Parameters

A method contains the following parameters:

Parameters	Refer to
Drying program	<a href="#">Drying program (on page 24)</a>
Drying temperature	<a href="#">Drying temperature (on page 24)</a>
Switch-off criterion (SOC)	<a href="#">Switch-off criterion (SOC) (on page 25)</a>

#### 5.2.1.1. Drying program

MB32 contains two types of drying programs:

- Standard
- Fast

An appropriate drying program should be selected depending on the feature of the sample to be analyzed.

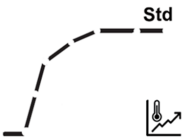
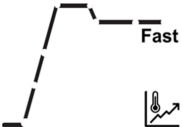
Name	Profile	Description
Standard		<p>The standard drying program is the most common and is sufficient for most samples.</p> <p>In this drying profile the target temperature is reached and sustained until the end of the measurement.</p>
Fast		<p><b>Fast</b> drying program is suitable for samples with higher moisture content, as it relies on available moisture to prevent charring of the sample.</p> <p>In this drying profile, the target temperature is exceeded by 40% (max 200 °C) for the first 3 minutes, then reverts to the target temperature which is sustained until the end of the measurement.</p>

#### 5.2.1.2. Drying temperature

The drying temperature range of MB32 is 40°C - 180°C.

## Good practice of Selecting Drying Temperature

The drying temperature exerts a controlling influence on the measurement time. It must be selected so that the sample neither decomposes nor changes its chemical structure. A drying temperature that is too low can unnecessarily prolong the drying time.

Note also that certain samples can give off different amounts of moisture at different drying temperatures. This is the case with substances in which the strength of the bonds binding the moisture varies or those which tend to show signs of decomposition. Minimum deviations from moisture content values of the reference method can be compensated by changing the drying temperature.

The following procedure is suggested for selecting the temperature.

- Estimate moisture content of the sample.
- Determine the decomposition temperature of the sample by experiments.
- Compare the measurement results with the reference method if one exists.
- If an excessive amount of moisture is involved, lower the drying temperature. If the experimental results are too low, the drying temperature was possibly too low or the drying time too short.

With samples which have a high moisture content, it is possible to shorten the measurement time by selection of the step or rapid drying program. Here, the greatest part of the existing moisture is separated at an elevated temperature.

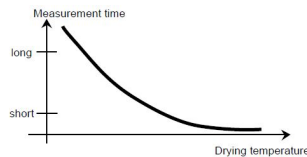

The drying temperature is then lowered and kept constant until the end of drying. The excessive temperature is used for rapid vaporization of the moisture, but the effective sample temperature does not exceed the boiling temperature of the liquid (cooling effect through endothermic vaporization). In certain cases, local heating and decomposition could still occur at the sample surface.



### 5.2.1.3. Switch-off criterion (SOC)

Switch-off criterion defines when the instrument should end the drying.

MB32 contains three types of **Switch-off criterion**:

<b>Switch-off criterion</b>	<b>Definition</b>
<b>Auto Shut Off</b>	<p>The switch-off criterion is based on a weight loss per unit of time. As soon as the mean weight loss is less than a preset value during a specified time, the instrument considers drying as complete and automatically discontinues the measurement process.</p> <p>During drying, the display indicates the elapsed time of the drying process.</p> <div style="background-color: #f0f0f0; padding: 5px; margin: 10px 0;"> <p> <b>Note:</b> The switch-off criterion is inactive during the first 30 seconds.</p> </div> <p>Options of <b>Auto Shut Off</b>:</p> <ul style="list-style-type: none"> <li>• A10 - Less than 1mg loss in 10 seconds, used for samples which dry very quickly (surface moisture) or for (relatively inaccurate) fast measurements to determine a trend.</li> <li>• A30 - Less than 1mg loss in 30 seconds, used for samples which dry quickly (surface moisture) or for (relatively inaccurate) fast measurements to determine a trend.</li> <li>• A60: Less than 1mg loss in 60 seconds, used for most types of samples.</li> <li>• A90: Less than 1mg loss in 90 seconds, used for slow drying substances.</li> </ul>
<b>Timed Shut Off</b>	<p>The drying session will stop based on a preset time.</p> <p>The time can be set from <b>00:30</b> seconds to <b>07:59</b> hours.</p>
<b>Manual Shut Off</b>	<p>Switch off drying manually by pressing  </p>

## 5.2.2. User Operations

Users can perform the following **Method**-related actions:



Actions	Refer to
Create a new method	<a href="#">Create a new Method (on page 27)</a>
Select a Method	<a href="#">Load a Method (on page 27)</a>
Edit an Existed Method	<a href="#">Edit an Existed Method (on page 28)</a>
Delete a Method	<a href="#">Delete a Method (on page 28)</a>

### 5.2.2.1. Create a new Method

1. Rotate the **Rotation knob**. The **Method ID**  will start to blink.
2. Select an empty method > **Edit method**  
When navigate to an empty method, the display screen is plain with only **Method ID** blinking.
3. Select a **Select drying program**.  
For deciding which drying program to be used, please refer to [Drying program \(on page 24\)](#)

4. Configure the target temperature  .
5. Configure the **Switch-off criterion**  
For more information about **Switch-off criterion**, please refer to [Switch-off criterion \(SOC\) \(on page 25\)](#)

### 5.2.2.2. Load a Method

1. Rotate the **Rotation knob**. The **Method ID**  will start to blink.
2. Navigate to the desired method > short press **Rotation knob** > short press the knob again to confirm selection. The selected method will be used in the measurements.  
After a method is confirmed, the screen will back to the Home screen. The **Method ID**  will display the ID you have just confirmed.

### 5.2.2.3. Edit an Existed Method

1. Rotate the **Rotation knob**. The **Method ID**  will start to blink.
2. Navigate to the method to be edited, then short press the **Rotation knob**.
3. Navigate to **Edit method**, then short press the **Rotation knob** to enter method editing.
4. Configure **Drying Program**, **Drying Temperature**, and **Switch-off criterion** in sequence. If there's no change to a parameter, short press the **Rotation knob** to move on.



#### Note:

For guidance on selecting a **Drying Program** and **Switch-off criterion**, please refer to:

- [Drying program \(on page 24\)](#)
- [Switch-off criterion \(SOC\) \(on page 25\)](#)

### 5.2.2.4. Delete a Method



#### Attention:

When a **Method** is deleted, the corresponding **Results** will also be deleted.

1. Rotate the **Rotation knob**. The **Method ID**  will start to blink.
2. Navigate to the method to be deleted, then short press the **Rotation knob**.
3. Navigate to **Delete method**, then short press the **Rotation knob** to delete the method.  
The screen will display a confirmation note, e.g. "**Method 0 ! Deleted.**"

## 5.3. Weight and Temperature Adjustment

### 5.3.1. Weight Adjustment

The Moisture Analyzer can be adjusted with an external mass of 50 grams. Adjustment of the Moisture Analyzer is not absolutely necessary for a correct moisture determination as the measurement is relative. The balance determines the weight of the sample before and after drying and the moisture is calculated on the basis of the ratio between wet and dry weights.

Nevertheless, you should adjust the built-in balance under the following conditions:

- If this is stipulated by your quality assurance system (GLP, GMP, ISO 9001).
- If you suspect the analyzer has been abused.

#### 5.3.1.1. Perform Weight Adjustment

##### Prerequisites

1. The moisture analyzer is levelled.
2. Have an external mass of 50 grams.
3. The sample pan is removed.

##### Steps of Weight Adjustment

1. Long press the **Rotation knob** to enter the menu.



2. Navigate to **> Adjustment > Weight Adjustment** . The unit will initialize the process and display **Adjustment in progress....**
3. Place the 50g mass on the center of the Pan Holder.

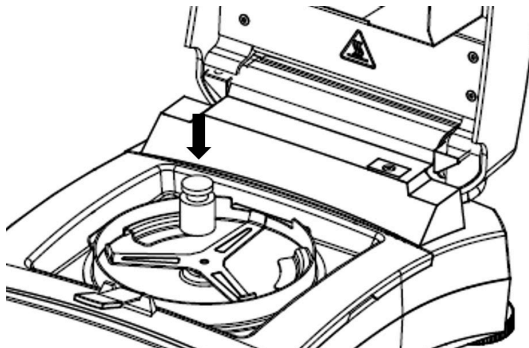

4. Then the screen will display "**Adjustment in progress...**"

**Note:**

To abort **Weight Adjustment**, press



5. Then, the screen will display **Please remove the weights**.

After the weights are removed, the screen will display **Adjustment in progress...** > **Adjustment done**. Then press tare to return to the home screen.

### 5.3.1.2. View Weight Adjustment History

MB32 stores the latest valid adjustment history.

To navigate to the Weight Adjustment History:

Long press the **Rotation knob** >  > **Adjustment** > **History-Weight Adjustment**.

It provides the below weight adjustment information:

- **Date and time**
- **Temperature**
- **Nominal weight**
- **Actual weight**
- **Difference**
- **Adjustment: done**

### 5.3.2. Temperature Adjustment

Proper temperature adjustment is a critical step in ensuring accurate moisture analysis results from your moisture analyzer. Inconsistent or inaccurate readings can occur if the temperature is not correctly controlled during the analysis process.

The moisture analyzer adopts a two-point adjustment (100°C and 160°C). The adjustment process takes about 30 minutes to complete.

During the adjustment, the dryer unit will heat and stabilize at the first temperature 100°C for 15 minutes, and then at the second temperature 160°C for 15 minutes. Adjustment of the temperature will be defined by these two points.

A Temperature Calibration Kit is required for temperature adjustment.

**Note:**

Mechanical Temperature Calibration Kit is available as Accessory. For details, please refer to [Accessory \(on page 43\)](#).

#### 5.3.2.1. Mechanical Temperature Adjustment

Prerequisites:

- Prepare a Mechanical Temperature Calibration Kit

To adjust the temperature of the moisture analyzer, processed as follows:



1. Long press the **Rotation knob** to enter the menu.



2. Navigate to **> Adjustment > Temp adjust-Mechanical kit**
3. **Remove pan holder and press knob.**
4. **Place temperature kit and press knob.**
5. **Close cover and press knob.**



**Note:**

In this first session, the dryer will heat and stabilize at 100°C for 15 minutes.

6. When the first session ends, the screen will display "**Enter temp reading from kit.**"  
Check the temperature measured by the Mechanical Temperature Calibration Kit, then rotate the knob to enter the temperature reading.
7. Press the knob to confirm. The second adjustment session will start.



**Note:**

In the second session, the dryer will heat and stabilize at 160°C for 15 minutes.

8. When the second session ends, the screen will display "**Enter temp reading from kit.**"  
Check the temperature measured by the Mechanical Temperature Calibration Kit, then rotate the knob to enter the temperature reading.
9. After enter the temperature reading, the screen will display "**Adjustment done,press tare.**"

Press **→T←** to return to the Home screen.

### 5.3.2.2. View Temperature Adjustment History

MB32 stores the latest valid temperature history.

To navigate to the Temperature Adjustment History:



Long press the **Rotation knob** > **> Adjustment > History-temp adjust.**

It provides the below temperature adjustment information:

- **Date and time**
- **Temp1 (target-actual)**
- **Temp2 (target-actual)**
- **Adjustment: done**

## 5.4. Print Management

MB32 is compatible to print Test Result, Weight Adjustment, and Temperature Adjustment data to an external computer or printer.

### 5.4.1. Configure Print Parameters

MB32 has preset the communication parameters for Printer connection.

However, if connection fails, please check if the parameters are correct:

- **Baud rate:** 9600
- **Transmission:** 8N1
- **Handshake:** X on/X off

### 5.4.2. Auto Printing

Users can choose to print data manually or automatically. By default, printing to an external printer or computer will occur each time the Print button is pressed.

Users can also select to auto-print each time a test or adjustment is completed, or during a measurement at specific intervals.

### Enable / Disable Auto-print Contents

For auto-print set up, please long press the **Rotation knob** and navigate to **Setting**



> **Communication** > **RS232** or **USB** (depending on how the moisture analyzer is connected with a printer) > **Print settings**, and configure the following print settings when necessary:

- **A.print weight adjust: Auto print weight adjustment result**
- **A.print temp adjust: Auto print temperature adjustment result**
- **A.print test result: Auto print measurement result**
- **A.print intmd result: Intermediate results print interval**

For more set-up information, please refer to [Print settings \(on page 38\)](#)

### 5.4.3. Print Contents

#### Default Print Contents

MB32 has preset a group of default print contents, allowing the user to directly print essential test and adjustment data without configuration beforehand.

Default print contents includes:

- **Type** (Moisture Analyser Type)
- **SNR**
- **SW** (Software version)
- **Method Name**
- **Drying program**
  - **Drying temperature**
  - **Switch-off criterion**
- **Start Weight**
- **Total time**
- **Dry Weight**
- **Moisture Content**
- **End Result**
- **Note**

-----Moisture Analyse-----	
<b>Type</b>	MB32
<b>SNR</b>	B94xxxxxxxx
<b>SW</b>	0.95.4
<b>Method Name</b>	Test
<b>Drying program</b>	<b>Standard</b>
<b>Drying temperature</b>	120°C
<b>Switch-off criterion</b>	<b>A60 (1 mg / 60 s)</b>
<b>Start Weight</b>	3g
<b>Total time</b>	3:25 min
<b>Dry Weight</b>	2.821g
<b>Moisture Content</b>	0.302g
<b>End Result</b>	9.67%
<b>Note</b>	
-----End-----	

## Optional Print Contents

Optional print contents are by default not printed. Users can enable them on request.

Optional printable contents include:

- **User name**
- **Project name**
- **Company name**
- **Department Name**
- **Instrument ID**
- **Signature**
- **Verified line**

## Select Optional Print Contents

1. Long press the **Rotation knob**



2. Navigate to **Setting** > **Communication** > **RS232** or **USB** (depending on how the moisture analyzer is connected with a printer) > **Print content**

3. Select the needed print content and configure to **ON**.

## 5.4.4. Connect to a Printer

MB32 is compatible to OHAUS SF40A.

### 5.4.4.1. Connect to SF40A Printer via RS232 Cable

#### Prerequisites

Before connecting, make sure the instrument and printer have the same RS232 Baud rate setting.

#### Connect to the Printer

1. Use the RS232 interconnecting cable to connect the instrument and the printer.
2. Switch on the instrument and the printer.  
When connected, the pilot lamp will stop blinking.



## 5.4.4.2. Connect to SF40A/BT Printer via Bluetooth

### Prerequisites

Before connecting, make sure the instrument and printer have the same RS232 Baud rate setting.

### Connect to the Printer

#### 1. Set DTE / DCE

- Printer-side BT adapter - yellow (30086492): **DCE**
- Instrument-side BT adapter - orange (30086493): **DTE**

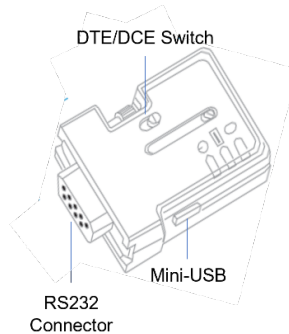

- #### 2. Connect the **Printer-side BT adapter - yellow (30086492)** into the RS232 interface of the printer.



- #### 3. Connect the **Instrument-side BT adapter - orange (30086493)** into the RS232 interface of the instrument.
- #### 4. Turn on the instrument and the printer.

When connected:

- The pilot lamp will stop blinking.
- The blue light on the Bluetooth adapter will stop blinking.
- The printer would print a message automatically, e.g. CONNECT "43C9-F0-9B5C03".

## 6. Settings

### 6.1. Enter the Settings

1. Long press the **Rotation knob** to enter the Menu.



2. Rotate to **Setting** , and then short press the knob to enter.

### 6.2. Sub Menus

#### 6.2.1. Adjustment

Sub Menu	Description	Refer to
<b>Weight Adjustment</b>	Performing weight Adjustment.	<a href="#">Weight Adjustment (on page 29)</a>
<b>Temp adjust-Mechanical kit</b>	Performing temperature adjustment with mechanical kit.	<a href="#">Temperature Adjustment (on page 30)</a>
<b>History-weight adjust</b>	Viewing latest weight adjustment record.	<a href="#">View Weight Adjustment History (on page 30)</a>
<b>History-temp adjust</b>	Viewing latest temperature adjustment record.	<a href="#">View Temperature Adjustment History (on page 31)</a>
<b>End</b>	Back to the previous menu.	

#### 6.2.2. General

Sub Menu	Description
<b>Language</b>	The instrument supports the following languages: English, German, French, Spanish, Italian, Polish, Turkish, Portuguese, Chinese, Japanese, Korean
<b>Brightness</b>	The screen brightness can be adjust in a range from 0 - 100.
<b>Beep</b>	Enable or disable the beep sound while pressing a button. <ul style="list-style-type: none"> <li>• <b>On</b>- Enable the beep sound while pressing a button</li> <li>• <b>Off</b> (default) - Disable the beeper</li> </ul>
<b>Auto dim</b>	Automatically turn off the backlight in a selected time. <ul style="list-style-type: none"> <li>• <b>10 mins</b></li> <li>• <b>20 mins</b></li> <li>• <b>30 mins</b></li> <li>• <b>Off</b> (default) - Keep the backlight on</li> </ul>

Sub Menu	Description
Auto off	Automatically turn off the moisture analyzer in a selected time. <ul style="list-style-type: none"> <li>• <b>30 mins</b></li> <li>• <b>1 hour</b></li> <li>• <b>2 hours</b></li> <li>• <b>Off</b> (default) - Keep the backlight on</li> </ul>
End	Back to the previous menu.

### 6.2.3. Communication

Sub Menu	Description
RS232	In this menu, you can configure: <ul style="list-style-type: none"> <li>• RS232 device settings (<b>Peripherals</b>)</li> <li>• <b>Print settings</b></li> <li>• <b>Print content</b></li> </ul> More details, please go to <a href="#">RS232 (on page 37)</a>
USB	In this menu, you can configure: <ul style="list-style-type: none"> <li>• <b>Print settings</b></li> <li>• <b>Print content</b></li> </ul> More details, please go to <a href="#">USB (on page 40)</a>
End	Back to the previous menu.

#### 6.2.3.1. RS232

The RS232 section introduces the menu of device settings (**Peripherals**), **Print settings** and **Print content** settings.

### Peripherals

Submenu	Description
Baud rate	<b>Baud rate</b> specifies the speed at which information is transmitted via RS232. It needs to be set the same on both the transmitting and receiving devices. The <b>Baud rate</b> options are 1200, 2400, 4800, 9600 (default), 19200, 38400, 57600, 115200
Transmission	The <b>Transmission</b> menu is to set the communication protocol that specify the format for transmitting data over RS232. It needs to be set the same on both the transmitting and receiving devices. The <b>Transmission</b> options are 7E1, 7E2, 7N1, 7N2, 7O1, 7O2, 8N1 (default), 8N2

Submenu	Description
<b>Handshake</b>	<p>The <b>Handshake</b> menu is to set the communication signal between the moisture analyzer and the printer or PC.</p> <p>The <b>Handshake</b> options are:</p> <ul style="list-style-type: none"> <li>• <b>Hardware</b></li> <li>• <b>X on/X off</b> (default)</li> </ul>

## Print settings

Submenu	Description
<b>Print output</b>	<p>The <b>Print output</b> menu is to set the output device.</p> <p>The output can be printed to:</p> <ul style="list-style-type: none"> <li>• <b>Printer</b> (default)</li> <li>• <b>PC</b></li> </ul>
<b>A.print weight adjust</b>	<p>The <b>A.print weight adjustAuto print weight adjustment result</b> refers to auto print weight adjustment results. When selected to <b>On</b>, the weight adjustment result will be printed automatically when the process is completed.</p> <p><b>A.print weight adjustAuto print weight adjustment result</b> options are:</p> <ul style="list-style-type: none"> <li>• <b>On</b> - Enable auto print of weight adjustment result.</li> <li>• <b>Off</b> (default) - Weight adjustment result will be printed manually.</li> </ul>
<b>A.print temp adjust</b>	<p>The <b>A.print temp adjustAuto print temperature adjustment result</b> refers to auto print temperature adjustment result. When selected to <b>On</b>, the temperature adjustment result will be printed automatically when the process is completed.</p> <p><b>A.print temp adjustAuto print temperature adjustment result</b> options are:</p> <ul style="list-style-type: none"> <li>• <b>On</b> - Enable auto print of temperature adjustment result.</li> <li>• <b>Off</b> (default) - Temperature adjustment result will be printed manually.</li> </ul>
<b>A.print test result</b>	<p>The <b>A.print test resultAuto print measurement result</b> refers to auto print the test result. When selected to <b>On</b>, the test result will be printed automatically when the measurement is completed.</p> <p><b>A.print test resultAuto print measurement result</b> options are:</p> <ul style="list-style-type: none"> <li>• <b>On</b> - Enable auto print of test result.</li> <li>• <b>Off</b> (default) - Test results will be printed manually.</li> </ul>



Submenu	Description
<b>A.print intmd result</b>	<p>The <b>A.print intmd result</b> menu is to enable or disable to intermediate print during the drying.</p> <p><b>A.print intmd result</b> options are:</p> <ul style="list-style-type: none"> <li>• <b>Off</b> (default) : Disable auto print during drying</li> <li>• <b>5s</b>: Print data every 5 seconds during the drying process.</li> <li>• <b>10s</b>: Print data every 10 seconds during the drying process.</li> <li>• <b>30s</b>: Print data every 30 seconds during the drying process.</li> <li>• <b>1min</b>: Print data every 1 minute during the drying process.</li> </ul>
<b>Feed</b>	<p><b>Feed</b> options are:</p> <ul style="list-style-type: none"> <li>• <b>1 Line</b></li> <li>• <b>4 Lines</b> (default)</li> </ul>

## Print content

The **Print content** menu is to configure the optional print contents

- Select **On** to include the content in the print output.
- Select **Off** to exclude the content in the print output.

Optional printable contents include:

- **User name**
- **Project name**
- **Company name**
- **Department Name**
- **Instrument ID**
- **Signature**
- **Verified line**



### Note:

For information about print out of Test Results, please refer to [Print Management](#) (on page 32)

## 6.2.3.2. USB

The USB section introduces the menu of **Print settings** and **Print content** settings.

### Print settings

Submenu	Description
<b>A.print weight adjust</b>	<p>The <b>A.print weight adjustAuto print weight adjustment result</b> refers to auto print weight adjustment results. When selected to <b>On</b>, the weight adjustment result will be printed automatically when the process is completed.</p> <p><b>A.print weight adjustAuto print weight adjustment result</b> options are:</p> <ul style="list-style-type: none"> <li>• <b>On</b> - Enable auto print of weight adjustment result.</li> <li>• <b>Off</b> (default) - Weight adjustment result will be printed manually.</li> </ul>
<b>A.print temp adjust</b>	<p>The <b>A.print temp adjustAuto print temperature adjustment result</b> refers to auto print temperature adjustment result. When selected to <b>On</b>, the temperature adjustment result will be printed automatically when the process is completed.</p> <p><b>A.print temp adjustAuto print temperature adjustment result</b> options are:</p> <ul style="list-style-type: none"> <li>• <b>On</b> - Enable auto print of temperature adjustment result.</li> <li>• <b>Off</b> (default) - Temperature adjustment result will be printed manually.</li> </ul>
<b>A.print test result</b>	<p>The <b>A.print test resultAuto print measurement result</b> refers to auto print the test result. When selected to <b>On</b>, the test result will be printed automatically when the measurement is completed.</p> <p><b>A.print test resultAuto print measurement result</b> options are:</p> <ul style="list-style-type: none"> <li>• <b>On</b> - Enable auto print of test result.</li> <li>• <b>Off</b> (default) - Test results will be printed manually.</li> </ul>
<b>A.print intmd result</b>	<p>The <b>A.print intmd resultIntermediate results print interval</b> menu is to enable or disable to intermediate print during the drying.</p> <p><b>A.print intmd resultIntermediate results print interval</b> options are:</p> <ul style="list-style-type: none"> <li>• <b>Off</b> (default) : Disable auto print during drying</li> <li>• <b>5s</b>: Print data every 5 seconds during the drying process.</li> <li>• <b>10s</b>: Print data every 10 seconds during the drying process.</li> <li>• <b>30s</b>: Print data every 30 seconds during the drying process.</li> <li>• <b>1min</b>: Print data every 1 minute during the drying process.</li> </ul>
<b>Feed</b>	<p><b>Feed</b> options are:</p> <ul style="list-style-type: none"> <li>• <b>1 Line</b></li> <li>• <b>4 Lines</b> (default)</li> </ul>

## Print content

The **Print content** menu is to configure the optional print contents

- Select **On** to include the content in the print output.
- Select **Off** to exclude the content in the print output.

Optional printable contents include:

- **User name**
- **Project name**
- **Company name**
- **Department Name**
- **Instrument ID**
- **Signature**
- **Verified line**



### Note:

For information about print out of Test Results, please refer to [Print Management \(on page 32\)](#)

### 6.2.4. GLP/GMP Data

In the **GLP/GMP** menu, users can configure GLP and GMP data, including:

- **Project name**
- **Company name**
- **Department name**
- **Instrument ID**

These data can be printed as optional print contents. For setting optional print contents, please refer to [Print Contents \(on page 32\)](#)

The values will be configured digit by digit. You can rotate the knob to select a number (0-9), a letter (A-Z, a-z), a space, or a dash (-).

To configure the values:

1. Enter the submenu
2. Edit the first digit by rotating the knob to select a desired value.
3. Press the knob to confirm and move to the next digit. Continue this step until all digits are selected.
4. Press the back button to select:
  - **Save** - to confirm the setting
  - **Discard** - to ignore the setting.

### 6.2.5. System and Data

Sub Menu	Description
<b>Clear methods</b>	1. Select <b>Yes</b> to remove all methods. 2. Select <b>No</b> to return to the previous sub-menu.
<b>End</b>	Back to the previous menu.

## 6.2.6. Reset

Sub Menu	Description
<b>Reset General</b>	<ol style="list-style-type: none"> <li>1. Select <b>Yes</b> to reset all settings the from the <b>General</b> menu.</li> <li>2. Select <b>No</b> to return to the previous submenu.</li> </ol>
<b>Reset GLP/GMP</b>	<ol style="list-style-type: none"> <li>1. Select <b>Yes</b> to reset all settings from the <b>GLP/GMP</b> menu.</li> <li>2. Select <b>No</b> to return to the previous submenu.</li> </ol>
<b>Reset Communication</b>	<ol style="list-style-type: none"> <li>1. Select <b>Yes</b> to reset all settings from the <b>Communication</b> menu.</li> <li>2. Select <b>No</b> to return to the previous submenu.</li> </ol>
<b>Factory reset</b>	Restore the instrument to its original factory settings <ul style="list-style-type: none"> <li>• Select <b>Yes</b> to restore the instrument to its original factory settings .</li> </ul>
<b>End</b>	Back to the previous menu.

## 6.2.7. Instrument info

Sub Menu	Description
<b>Instrument information</b>	The screen will display the following instrument information by scrolling: <ul style="list-style-type: none"> <li>• <b>Type</b></li> <li>• <b>SW</b> (Software version)</li> <li>• <b>SNR</b></li> </ul>

## 7. Accessory

<b>Material Number</b>	<b>Accessory</b>
30954234	Pan Handler, MB32 MB62 MB92
30954235	In-Use Cover, MB32 MB62
11113857	Temperature Calibration Kit
30284477	Scoop
30585411	Aluminum Pan (50)
80850087	Glass Fiber Pads (200)
80252477	Cage, Sample
80252478	Reusable Pan, Set (3), 7mm
80252479	Reusable Pan, Set (3), 14mm
30064202	SF40A Impact Printer

## 8. Maintenance

### 8.1. Cleaning



**WARNING:** Electric Shock Hazard. Disconnect the equipment from the power supply before cleaning. Make sure that no liquid enters the interior of the instrument.



**Attention:** Do not use solvents, harsh chemicals, ammonia or abrasive cleaning agents.

The housing may be cleaned with a cloth dampened with a mild detergent if necessary.

### 8.2. Replacing Power Line Fuse

If the instrument display fails to light after switching it on, check the power outlet first. If power is available, and the instrument fails to operate, the power fuse may be open (blown).



**WARNING:** Electric Shock Hazard. Disconnect the equipment from the power supply before replacing the fuse.

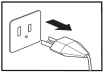

#### Steps to Replace Power Fuse Line

1. Use a screwdriver to take out the fuse holder.
2. Check the condition of the fuse. Replace blown fuse by those of the same type with the same rated value (6.3A 250VAC for 100-120VAC power supply or 2.5A 250VAC for 200-240VAC power supply according to the heating element).

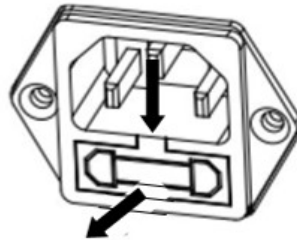

**Attention:** If the fuse is good and power is available at the outlet, the cord or instrument may be defective. Try a new cord. If this does not work, the instrument should be sent back for servicing.

The use of a fuse of a different type or with a different value, or bridging or shunting the fuse is not allowed and can possibly cause a hazard to your safety and lead to instrument damage!

## 8.3. Troubleshoot

Error Code	Problem	How to Fix
Err 8.0	Loadcell communication error	Reconnect the power. If the problem still exists, please contact Ohaus.
Err 8.1	Over initial zero range	Please remove the samples and the sample pan from the pan holder.
Err 8.2	Under initial zero range	Re-install pan holder.
Err 8.3	Overload	Please remove the samples and the sample pan from the pan holder.
Err 8.4	Under load, no pan holder.	Re-install pan holder.
Err 9.5	Factory calibration data corrupted	Not fixable by user. Please contact Ohaus.
Err 54	Temperature calibration parameters error.	Not fixable by user. Please contact Ohaus.
Err 10.3	Temperature sensor out of range – high	Not fixable by user. Please contact Ohaus.
Err 10.4	Temperature sensor out of range – low	Not fixable by user. Please contact Ohaus.
Err 10.5	Temperature remain unchanged after the start up.	Unstable power voltage. Please turn off the high wattage instruments around the moisture analyser, and then re-start the moisture analyser and try again. If the problem still exists, please contact Ohaus.
Err 10.6	Continuous high power during heating	Unstable power voltage. Please contact Ohaus.
Err 10.7	Heating overshoot exceeds 20 °C over the target temperature.	Not fixable by user. Please contact Ohaus.

## 8.4. Technical Support Information

For technical issues, please speak to an Authorized Ohaus Service Agent. Please visit our website [www.ohaus.com](http://www.ohaus.com) to find the Ohaus office nearest you.

## 9. Technical Data

### Conditions

The technical data is valid under the following conditions:

Indoor Use Only

Altitude: Up to 2000m

Operating temperature: 5 °C to 40 °C.

Humidity Maximum relative humidity 80% for temperatures up to 31 °C decreasing linearly to 50% relative humidity at 40°C.

Electrical Supply: 100 - 120V~, 5A or 200 - 240V~, 2.5A (depending on region)

Mains supply voltage fluctuations: Up to ±10 % of the nominal voltage

Overvoltage category (Installation Category): II

Pollution Degree: 2

Power line fuse: 6.3A 250 VAC for 100V-120VAC power supply  
2.5A 250VAC for 200V-240VAC power supply

### Specifications

Model	MB32
Capacity	90
Readability	0.01%/0.001g
Repeatability (Std Dev) (g)	0.15% (3g sample)
	0.02% (10g sample)
Moisture range	0.01% to 100% (0.01% to 1000% for regain mode)
Heating Element	Carbon fiber heater
Drying Programs	Standard, Fast
Temp range	40°C - 180°C
Switch-off Criteria	Timed, Auto (30, 60, 90 seconds), manual
Adjustment	External adjustment mass - 50g
Power	100V – 120 VAC 5A 50/60 Hz or 200V – 240 VAC 2.5A 50/60 Hz (depending on region)
Operating temperature range	41° to 104°F / 5° to 40°C
Display type	4', Segment and dot matrix
Display results	%moisture, %solids, %regain, time, temperature, weight
Pan size (mm)	90



<b>Model</b>	<b>MB32</b>
Interface	RS232, USB device
Adjustable Feet and Level	Yes
Dimensions (WxHxD) (cm)	21x18x30
Net wt. (kg)	4.3
Shipping wt. (kg)	7





# 10. User Commands

## OHAUS Commands

<b>Command</b>	<b>Action</b>
ON	Same function as <<On/Off>> key
OFF	Same function as <<On/Off>> key
P	Print stable weight. Same function as <<Print>> key
S	Print stable weight (in different format as P).
SI	Print the current weight.
SIR	Repeat the printing of the current weight
Z	Same function as <<Zero>> key
ZI	Immediate Zero
T	Same function as <<Tare>> key
TI	Immediate Tare
C2	Command of Weight Calibration
PV	Print terminal software version
PSN	Print Serial Number
IP	Immediate Print of displayed weight (stable or unstable)

# 11. Compliance

Compliance to the following standards is indicated by the corresponding mark on the product.

Mark	Standard
	This product complies with the applicable harmonized standards of EU Directives 2011/65/EU (RoHS), 2014/30/EU (EMC) and 2014/35/EU (LVD) The EU Declaration of Conformity is available online at <a href="http://www.ohaus.com/ce">www.ohaus.com/ce</a> .
	This product complies with the applicable statutory standards of the Restriction of the Use of Certain Hazardous Substances in Electrical and Electronic Equipment Regulations 2012, UK Electromagnetic Compatibility Regulations 2016 and Electrical Equipment (Safety) Regulations 2016. The UK Declaration of Conformity is available online at <a href="http://www.ohaus.com/uk-declarations">www.ohaus.com/uk-declarations</a> .
	This product complies with the EU Directive 2012/19/EU (WEEE). Please dispose this product in accordance with local regulations at the collecting point specified for electrical and electronic equipment. For disposal instructions in Europe, refer to <a href="http://www.ohaus.com/weee">www.ohaus.com/weee</a> .
	EN 61326-1
	CAN/CSA-C22.2 No. 61010-1, CAN/CSA-C22.2 No. 61010-2-010 UL 61010-1, UL 61010-2-010

## ISED Canada Compliance Statement:

CAN ICES-003(A) / NMB-003(A)

## ISO 9001 Registration

The management system governing the production of this product is ISO 9001 certified.

# 11.1. FCC Supplier Declaration of Conformity

## Unintentional Radiator per 47CFR Part B

Trade Name: OHAUS CORPORATION

Model: MB32

**Party issuing Supplier's Declaration of Conformity:**

Ohaus Instruments (Changzhou) Co., Ltd.  
C Block, 6 Zhengqiang Road, Xinbei District, Changzhou  
Jiangsu 213022,  
China  
Phone: +86 519 85287270

**Responsible Party – U.S. Contact Information:**

Ohaus Corporation  
8 Campus Drive, Suite 105  
Parsippany, NJ 07054  
United States  
Phone: +1 973 377 9000  
Web: [www.ohaus.com](http://www.ohaus.com)

**FCC Compliance Statement:**

Note: This equipment has been tested and found to comply with the limits for a Class A digital device, pursuant to part 15 of the FCC Rules. These limits are designed to provide reasonable protection against harmful interference when the equipment is operated in a commercial environment. This equipment generates, uses, and can radiate radio frequency energy and, if not installed and used in accordance with the instruction manual, may cause harmful interference to radio communications.

Operation of this equipment in a residential area is likely to cause harmful interference in which case the user will be required to correct the interference at his own expense.

Changes or modifications not expressly approved by the party responsible for compliance could void the user's authority to operate the equipment.

## 12. Limited Warranty

OHAUS products are warranted against defects in materials and workmanship from the date of delivery through the duration of the warranty period. During the warranty period OHAUS will repair, or, at its option, replace any component(s) that proves to be defective at no charge, provided that the product is returned, freight prepaid, to OHAUS.

This warranty does not apply if the product has been damaged by accident or misuse, exposed to radioactive or corrosive materials, has foreign material penetrating to the inside of the product, or as a result of service or modification by other than OHAUS. In lieu of a properly returned warranty registration card, the warranty period shall begin on the date of shipment to the authorized dealer. No other express or implied warranty is given by OHAUS Corporation. OHAUS Corporation shall not be liable for any consequential damages.

As warranty legislation differs from state to state and country to country, please contact OHAUS or your local OHAUS dealer for further details.