



AF03GT

Program for weighbridges

USER MANUAL - v7

ENGLISH

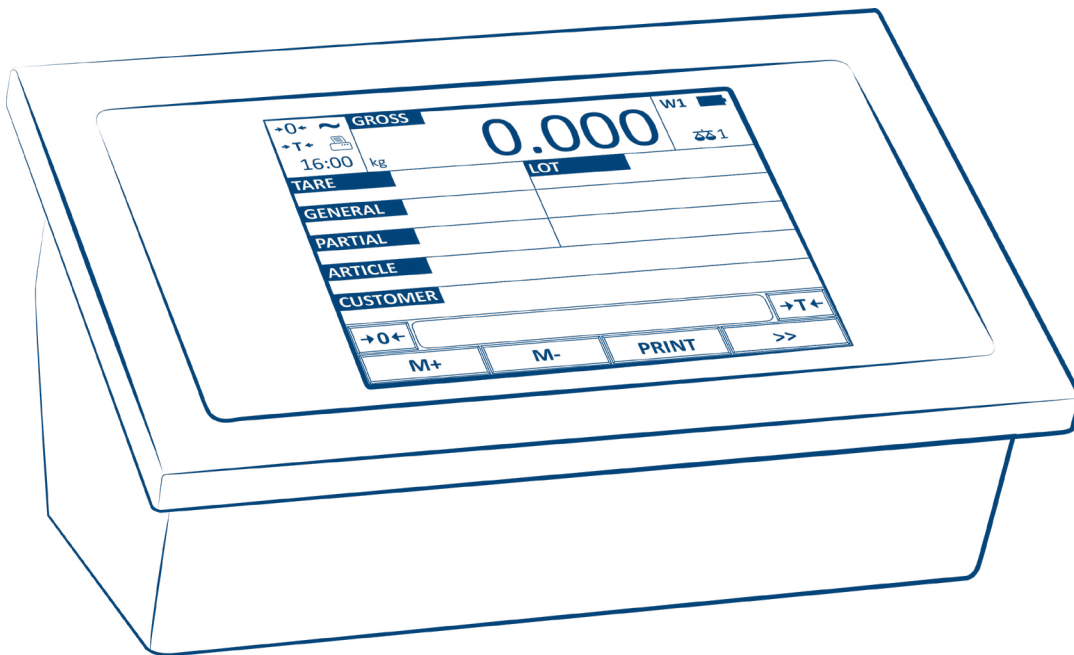

For 3590 series touch screen indicators

Introduction

Basic information

Weighing type	7
Multiple weighing	7
Single weighing	7
Possible configurations	8

Display - Main screens

Vehicle weighing functions

Multiple weighing with vehicle identification by automatic ID code	A-1
Multiple weighing with vehicle identification by plate	A-2
Multiple weighing with selection of database record	A-4
Multiple weighing of vehicles with trailer on one weighbridge only	A-6
Multiple weighing of vehicles with trailer on two weighbridges	A-8
“A + B” operating mode with two weighbridges	A-10
Manual entry of the first weighing (preset weigh)	A-11
Second weighing by reading the barcode	A-13
Instrument networking for database and weighings sharing	A-15
Management of barriers and traffic lights	A-16
Weighing with axle control	A-17
Reissue of closed weighing	A-18
List of weighings performed	A-18

General weighing functions

Resetting the weight	B-1
Weight view zoom	B-1
High resolution weight	B-2
Calculator	B-3
Operation with several scales	B-4

Databases

500 Customers / 250 suppliers database	C-1
Fields of customer / supplier database	C-3
500 materials database	C-4
Fields of materials database	C-6
500 vehicles database	C-7
Fields of vehicles database	C-9
Entering weighing identifier texts	C-10
1000 cards database	C-11
Password to access the database management menu	C-13
Compiling database from PC with “DBManager”	C-13

Self service weighing functions

Introduction	D-1
--------------	-----

Display - main self service function screens	D-2
Operation with badge / RFID	D-3
Multiple weighing with barcode reading	D-5
Operation with RF remote control	D-6
Remote control configuration (up to 1000)	D-7
Card configuration (up to 1000)	D-8
Weighing charge with coin acceptor	D-9
Instant debit / postponed payment weighing or free weighing	D-11
How to assign the payment system for each customer	D-12
How to know the debt accumulated by a customer	D-13
How to know and clear the total paid by a customer	D-13
How to request a driver to enter some data	D-14

Data Printing / Communication / Transmission

Simple print	E-1
Customisable print format	E-2
Multi-copy printing	E-2
Repeat last printout	E-4

Saving weighings

Real time saving on USB mobile media	F-1
Saving on alibi memory	F-2
Read the alibi memory	F-3
Saving weighings to PC via "WeiMonitor" program	F-4

Customising the weight indicator

Operational sequences	G-1
Operational messages	G-2
Application program	G-2
Customising the communication protocol	G-2
Fully customisable work screens	G-3
Customising language / texts	G-3

Managing automations

Setpoint / dosage	H-1
Digital inputs	H-2
Optional analogue interface 4..20mA 0..10V	H-3
Expanding inputs and outputs	H-3
Expansion of power supply range	H-3
Timed relays	H-4

Adjustments

Setting the date and time	I-1
---------------------------	-----

Adjusting the display brightness	I-1
Weighing speed (weighing filter)	I-2
Visual weight check in multiple colours	I-3

Identification of the metrological software

FAQ - Frequently Asked Questions

Introduction

Dear customer,

We thank you for choosing a Dini Argeo weight indicator.

The purpose of this manual is to describe the functioning of the weight program named AF03. It is specific for weighbridges, in its original factory settings.

This program includes all the most modern weighbridges management functions, both in manual and self-service mode, with particular attention to use simplicity and data integration with the company's information system.

It is also possible to configure and customise the program completely.

For any further information or specific request, we invite you to contact your dealer.

Weighing type

A vehicle can be weighed in two ways:

- **Multiple weighing**, typical of areas for goods receipt / freight forwarding, in caves, in quarries;
- **Single weighing**, used in weighing stations or self-service.

Multiple weighing

Multiple weighing allows to know the weight of the vehicle transported material through the difference between two weighs, carried out in different moments (e.g. inward and outward), first with loaded and then with unloaded vehicle, and vice versa. It can be executed by an operator through manual operations to be done by the weight terminal, or directly by the driver alone, with the help of badges or barcodes (self-service mode).

The two weighs which permit to calculate the difference are named **FIRST WEIGH** and **SECOND WEIGH**.



The **FIRST WEIGH** is stored by the instrument and printed together with its univocal code, called **weighing code**, which will be recalled in the second weigh in order to calculate the difference.

The weighing code can be automatically given by the instrument, and it is called **identifier or ID**. Alternatively, it can be the **vehicle's plate**, typed by the operator or selected from the vehicles database stored in the weight indicator.

Single weighing

Single weighing allows to know, in one weigh, the overall vehicle's weight (gross weight). Or, it is possible to know the net weight of the material transported, by entering in the indicator the weight of the empty vehicle.



Possible configurations

Single weighbridge

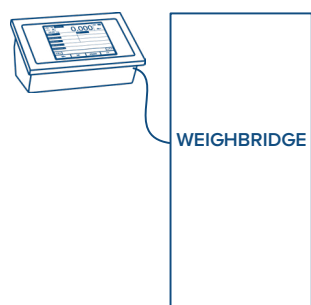

It is the most common configuration, with operator or self-service. It allows to carry out:

- Multiple weighing
- Single weighing
- Weighing of vehicles with trailers (double weighing)

Parallel weighbridge

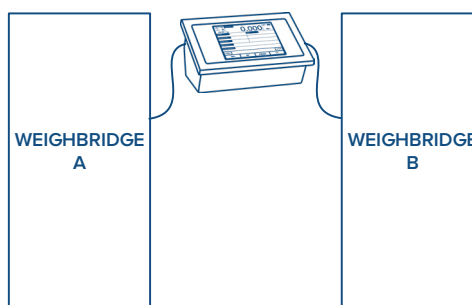

Configuration with two weighbridges, managed by an operator through the weight terminal. The following can be carried out:

- Multiple weighing only on A, only on B, or “mixed”, on A and B.
- Single weighing on A or on B.
- Weighing of vehicles with trailer (double weighing), on A or B

Combined weighbridge

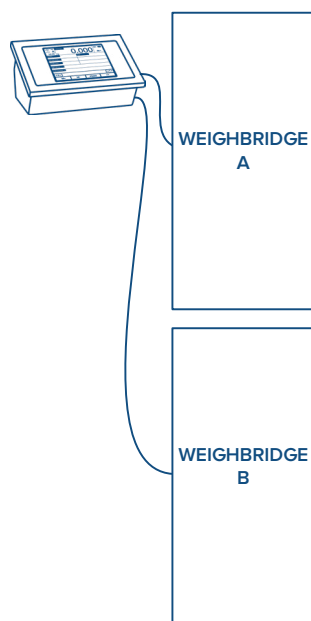

Configuration with two weighbridges, having an A+B sum functioning, managed by an operator through the weight terminal. This solution facilitates the weight of long vehicles, usually made of a tractor and a trailer

Multi-indicator weighbridge

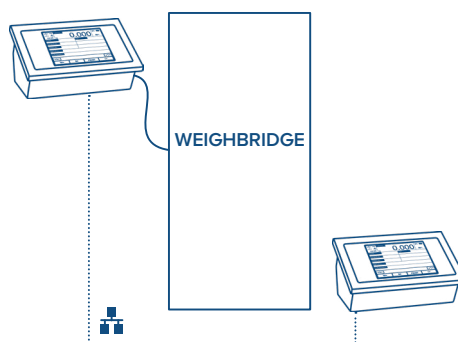

Self-service solution which allows to use the weighbridge in both directions. The weight indicators are interconnected, and share the weighing database. Thus, the first weight can be executed in one direction, and the second weight in the opposite one.

On-line weighbridges

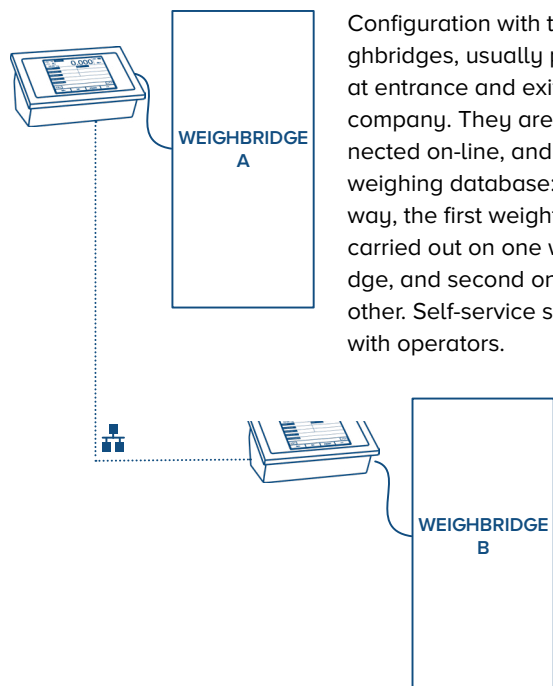

Configuration with two weighbridges, usually placed at entrance and exit of the company. They are interconnected on-line, and share the weighing database: in this way, the first weight can be carried out on one weighbridge, and second one on the other. Self-service solution or with operators.

Multi-indicator on-line weighbridges

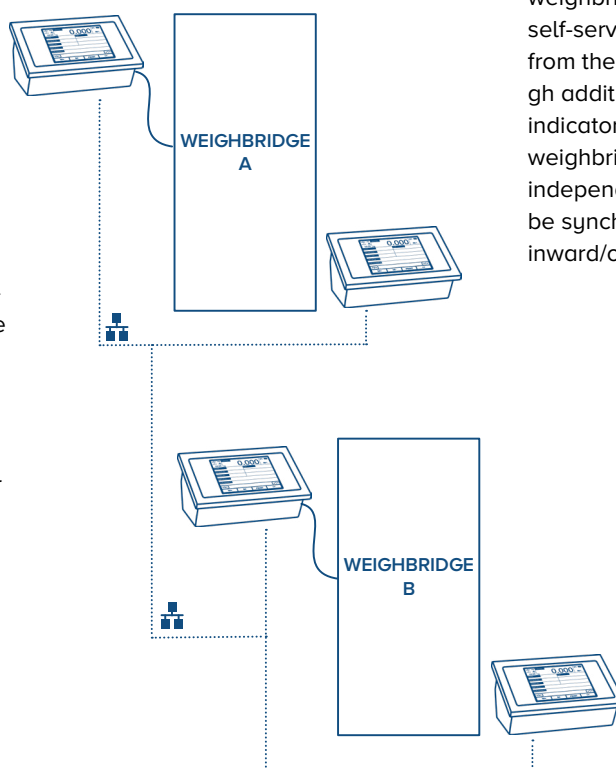

Configuration with two weighbridges, usually self-service, with check from the office through additional weight indicator or PC. The weighbridges can work independently, or can be synchronized in inward/outward.

Display - Main screens

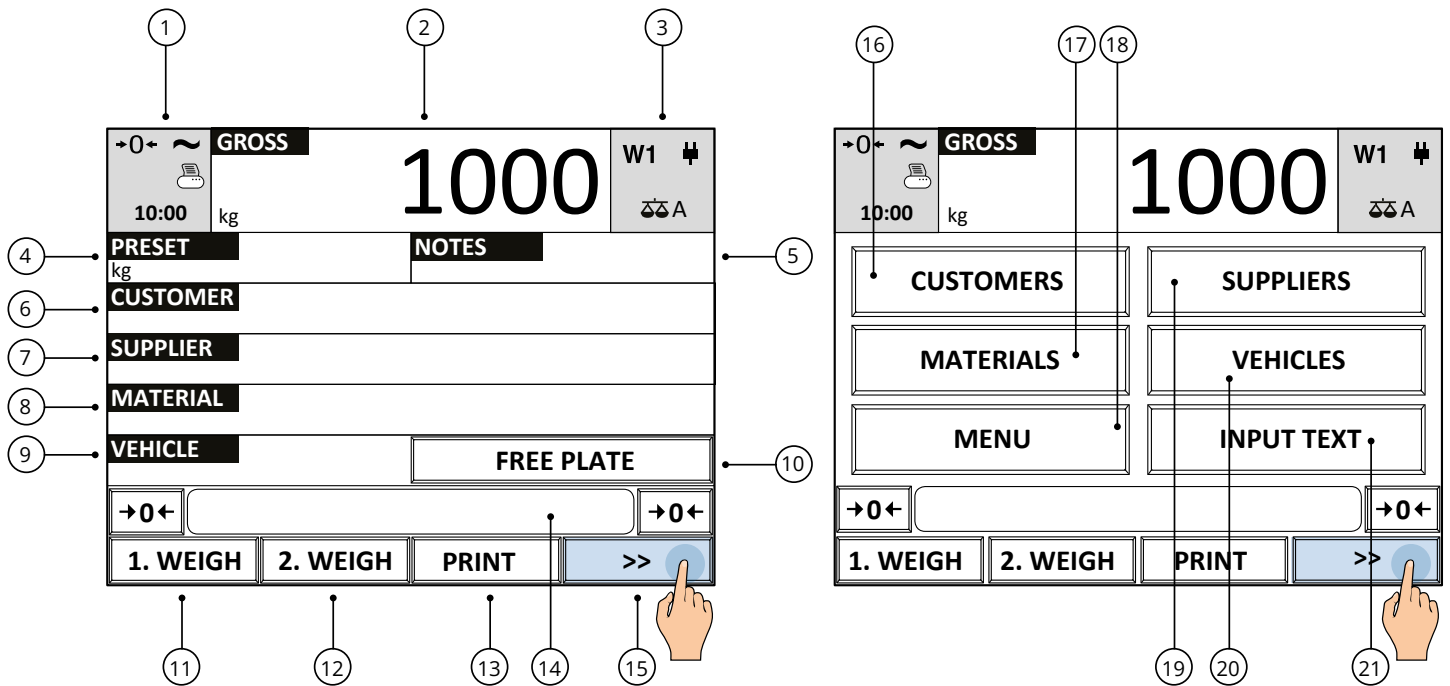

Button	Function
(1)	Setting date and time.
(2)	Net / gross weight display / zoom.
(3)	Scale change.
(4)	Preset weight for first weigh.
(5)*	Freely entered text.
(6)	Customer selection.
(7)	Supplier selection.
(8)	Material selection.
(9)	Vehicle selection.
(10)*	Temporary truck (entering numberplate).
(11)	Execution of the first weighing.
(12)	Execution of the second weighing.
(13)	Printing.
(14)	Operational messages.
(15)	Screen change.
(16)	Customer database.
(17)	Materials database.
(18)	Additional function menu.
(19)	Suppliers database.
(20)	Vehicles database.
(21)	Filling out / editing free text database.

Symbol	Description
→0←	The scale is unloaded and at zero (gross).
~	The weight is unstable.
🖨️ ⚠️ ⚡	Printing in progress / printer anomalies.
W1 W2 W3	Indicate the range of active weighing.
🔋	Powered / Battery level.
⚖️ A ⚖️ B	Active scale.
⚖️ A+B	"A+B" sum.

i * Point (5) is freely configurable.

i * The "FREE PLATE" key (10) in the weighing mode with ID identification lets you type the license plate of the vehicle to indicate it in the printout but does not let you bring up the outbound vehicle.

Vehicle weighing functions

Multiple weighing with vehicle identification by automatic ID code

USE	Lets you weigh the material transported by the vehicle by difference between first and second weighing. The first weighing is identified by automatic numeric ID.
ACTIVATION	Standard active function.

Registration procedure of the first weighing

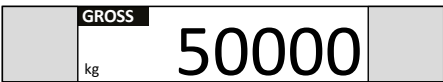
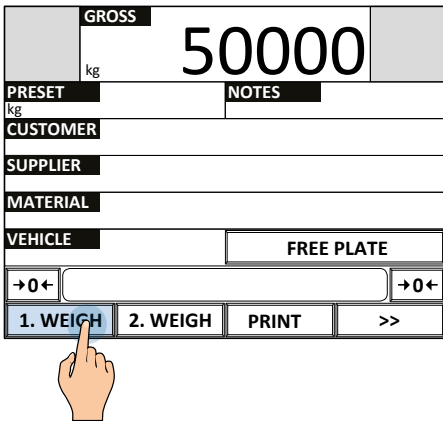
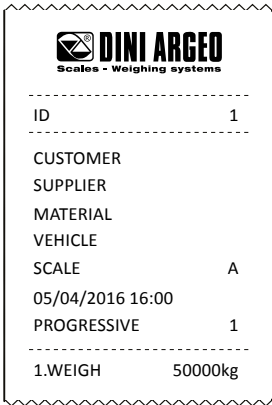
- 
- 
- 

i It is possible to choose whether to assign a progressive identification code to the first weighing (with automatic reset after 999 weighings), or the first identification code available in memory (in this case the identification code is released once the second weighing is carried out).

Registration procedure of the second weighing

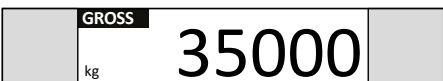
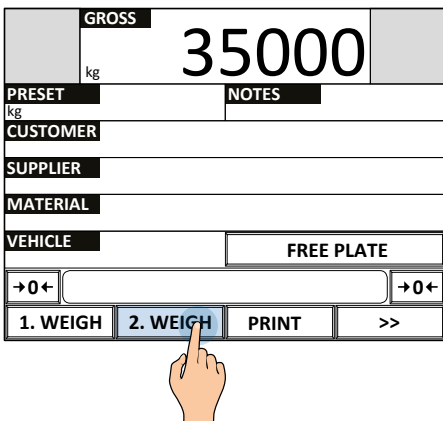
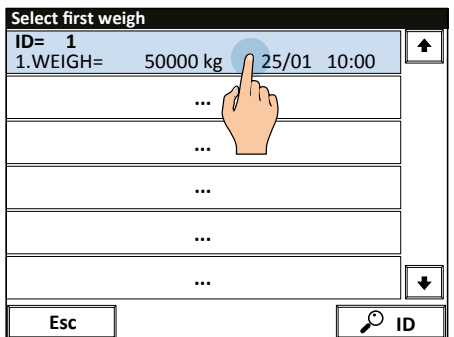
- 
- 
- 

4. Summary screen. Press OK to confirm.

GROSS		35000	
kg			
1. WEIGH	50000	2. WEIGH	35000
kg		kg	
NET		15000	
kg			
NOTE1		NOTE2	
CUSTOMER		SUPPLIER	
MATERIAL		VEHICLE	
Esc	←	OK	



5. Printing is automatic and shows the first weighing, the second weighing and the difference.

DINI ARGEO
Scales - Weighing systems

ID 1

CUSTOMER

SUPPLIER

MATERIAL

VEHICLE

SCALE A

05/04/2016 16:00

PROGRESSIVE 2

1.WEIGH 50000kg

2.WEIGH 35000kg

NET 15000kg

6. Now it is possible to print one or more copies of the receipt, or unload the weighbridge / press ESC to return to weighing mode.

GROSS		35000	
kg			
1. WEIGH	50000	2. WEIGH	35000
kg		kg	
NET		15000	
kg			
NOTE1		NOTE2	
CUSTOMER		SUPPLIER	
MATERIAL		VEHICLE	
Esc		COPY	



The "FREE PLATE" key in the weighing mode with ID identification lets you type the license plate of the vehicle to indicate it in the printout but does not let you bring up the vehicle to get the second weigh.

Multiple weighing with vehicle identification by plate

USE	Lets you weigh the material transported by the vehicle by difference between first and second weighing. The first weighing is identified by entering the vehicle's plate.
ACTIVATION	Activation requires advanced configuration.



It is possible to store the plates of vehicles in the archive for quicker retrieval (see page C-9)

Registration procedure of the first weighing

GROSS		50000	
kg			



GROSS		50000	
kg			
PRESET		NOTES	
kg			
CUSTOMER			
SUPPLIER			
MATERIAL			
VEHICLE		FREE PLATE	
→0←			→0←
1. WEIGH	2. WEIGH	PRINT	>>



3. Enter the license plate of the vehicle

Plate									
XY 123 XY									
Esc	'	<	/]	Clear	BkSp			
1	2	3	4	5	6	7	8	9	0
Q	W	E	R	T	Y	U	I	O	P
A	S	D	F	G	H	J	K	L	;
2 nd F	Z	X	C	V	B	N	M	,	.
Shift	←								OK



4.

GROSS		50000	
kg			
PRESET	NOTES		
kg			
CUSTOMER			
SUPPLIER			
MATERIAL			
VEHICLE		FREE PLATE	
XY 123 XY			
+0←			→0+
1. WEIGH	2. WEIGH	PRINT	>>



Registration procedure of the second weighing

1.

GROSS		35000	
kg			



4. Summary screen. Press OK to confirm.

GROSS		35000	
kg			
1. WEIGH	50000	2. WEIGH	35000
kg		kg	
NET		15000	
kg			
NOTE 1	NOTE 2		
CUSTOMER		SUPPLIER	
MATERIAL		VEHICLE	
		XY 123 XY	
Esc	←		OK



7.



5. Printing is automatic and shows the plate

DINI AR GEO	
Scales - Weighing systems	
PLATE	XY 123 XY
CUSTOMER	
SUPPLIER	
MATERIAL	
VEHICLE	XY 123 XY
SCALE	A
05/04/2016 16:00	
PROGRESSIVE	1

1. WEIGH	50000kg

2.

GROSS		35000	
kg			
PRESET	NOTES		
kg			
CUSTOMER			
SUPPLIER			
MATERIAL			
VEHICLE		FREE PLATE	
XY 123 XY			
+0←			→0+
1. WEIGH	2. WEIGH	PRINT	>>



5. Printing is automatic and shows inbound, outbound weight and the difference.

DINI AR GEO	
Scales - Weighing systems	
PLATE	XY 123 XY
CUSTOMER	
SUPPLIER	
MATERIAL	
VEHICLE	XY 123 XY
SCALE	A
05/04/2016 16:00	
PROGRESSIVE	2

1. WEIGH	50000kg
2. WEIGH	35000kg

NET	15000kg

8. The weighbridge is ready for the next weighing operation

GROSS		0	
kg			
PRESET	NOTES		
kg			
CUSTOMER			
SUPPLIER			
MATERIAL			
VEHICLE		FREE PLATE	
+0←			→0+
1. WEIGH	2. WEIGH	PRINT	>>

6.



3. Select the first weighing identification string (PLATE)

Select first weigh	
PLATE=	XY 123 XY
1. WEIGH=	50000 kg 25/01 10:00
...	
...	
...	
...	
...	
...	
...	
Esc	A...Z



6. Now it is possible to print one or more copies of the receipt, or unload the weighbridge / press ESC to return to weighing mode.

GROSS		35000	
kg			
1. WEIGH	50000	2. WEIGH	35000
kg		kg	
NET		15000	
kg			
NOTE 1	NOTE 2		
CUSTOMER		SUPPLIER	
MATERIAL		VEHICLE	
		XY 123 XY	
Esc			COPY

i The free license plate is deleted automatically when the weigh is done or when the weighbridge is unloaded.

i It is also possible to select the license plate from data-base (C-7).

Multiple weighing with selection of database record

USE	Thanks to the database it is possible to identify the customer, supplier, transported material and vehicle, for complete traceability of the weighing.
ACTIVATION	Standard active function.

Registration procedure of the first weighing

1.

GROSS	kg	50000
-------	----	-------



2. Select the desired database

GROSS	kg	50000
PRESET	kg	NOTES
CUSTOMER		
SUPPLIER		
MATERIAL		
VEHICLE	FREE PLATE	
+0- +0-		
1. WEIGH	2. WEIGH	PRINT >>

3. Select the desired data

Select material	
0000	TEMPORARY
0001	KAOLIN
0002	CLAY
0003	SAND
0004	GRAVEL
0005	OTHER
0006	EMPTY
0007	EMPTY

Selected material: 0001

Esc DESELECT A...Z INDEX

4.

GROSS	kg	50000
PRESET	kg	NOTES
CUSTOMER	SMIDTH LTD	
SUPPLIER	WHITE LTD	
MATERIAL	KAOLIN	
VEHICLE	XY 123 XY	
+0- +0-		
1. WEIGH	2. WEIGH	PRINT >>



5.

DINI ARGEO Scales - Weighing systems	
PLATE	XY 123 XY
CUSTOMER	SMIDTH LTD
SUPPLIER	WHITE LTD
MATERIAL	KAOLIN
VEHICLE	XY 123 XY
SCALE	A
05/04/2016 16:00	
PROGRESSIVE	1
1. WEIGH	15000kg

6.



Registration procedure of the second weighing

1.

GROSS	kg	35000
-------	----	-------



2.

GROSS	kg	35000
PRESET	kg	NOTES
CUSTOMER		
SUPPLIER		
MATERIAL		
VEHICLE	FREE PLATE	
+0- +0-		
1. WEIGH	2. WEIGH	PRINT >>



3. Selecting the license plate of the first weighing

Select first weigh	
PLATE=	XY 123 XY
1.WEIGH=	50000 kg 25/01 10:00
...	
...	
...	
...	
...	
...	
...	

Esc A...Z

4. Summary screen. The database records selected in the first weighing can be edited before proceeding by pressing OK.

GROSS		kg 35000	
1. WEIGH	kg 50000	2. WEIGH	kg 35000
NET		kg 15000	
NOTE 1			NOTE 2
CUSTOMER	SUPPLIER		
SMIDTH LTD	WHITE LTD		
MATERIAL	VEHICLE		
KAOLIN	XY 123 XY		
Esc	←		OK



5. Printing is automatic and shows the first weighing, the second weighing and the difference.

DINI AR GEO
Scales - Weighing systems

PLATE XY 123 XY

CUSTOMER SMIDTH LTD
SUPPLIER WHITE LTD
MATERIAL KAOLIN
VEHICLE XY 123 XY

SCALE A
05/04/2016 16:00
PROGRESSIVE 2

1. WEIGH 50000kg
2. WEIGH 35000kg

NET 15000kg

6. Now it is possible to print one or more copies of the receipt, or unload the weighbridge / press ESC to return to weighing mode.

GROSS		kg 35000	
1. WEIGH	kg 50000	2. WEIGH	kg 35000
NET		kg 15000	
NOTE 1			NOTE 2
CUSTOMER	SUPPLIER		
SMIDTH LTD	WHITE LTD		
MATERIAL	VEHICLE		
KAOLIN	XY 123 XY		
Esc		COPY	

7.



8.

GROSS		kg 0	
PRESET			NOTES
kg			
CUSTOMER			
SUPPLIER			
MATERIAL			
VEHICLE		FREE PLATE	
→0←			→0←
1. WEIGH	2. WEIGH	PRINT	>>

i By unloading the weighbridge the selected database records are deselected automatically.

Multiple weighing of vehicles with trailer on one weighbridge only

USE	Lets you weigh a vehicle with trailer using a shorter weighbridge, making the weighing in two operations (first the traction vehicle, then the trailer).
ACTIVATION	Activation requires advanced configuration.

Registration procedure of the first weighing

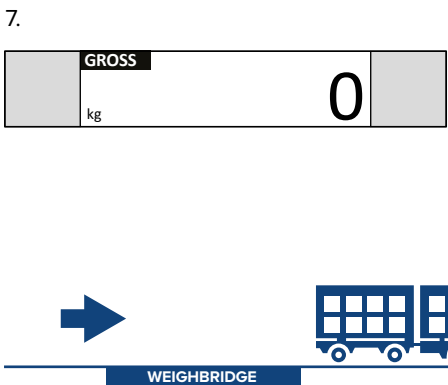
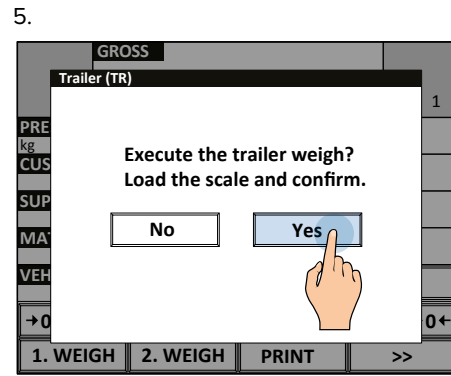
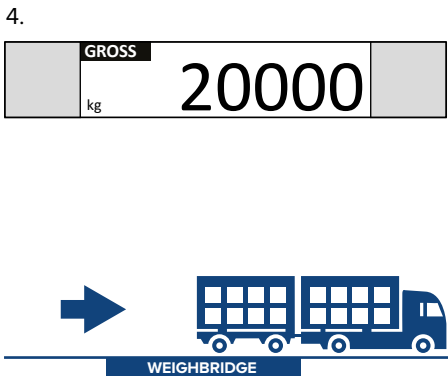
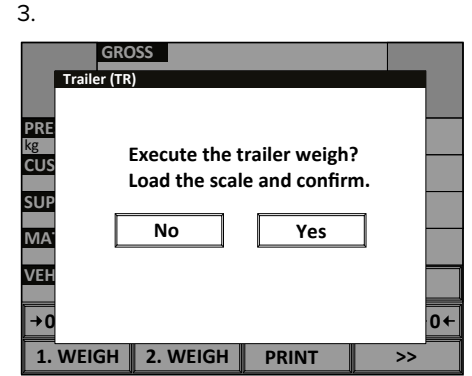
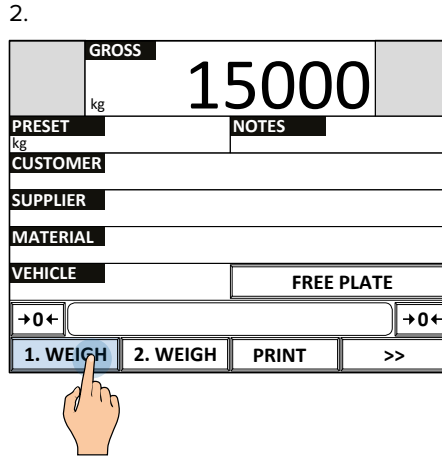
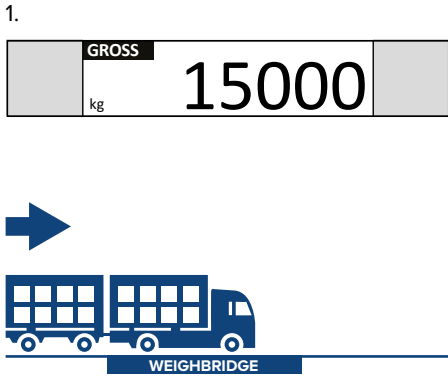

Registration procedure of the second weighing

1.

GROSS		10000
kg		



WEIGHBRIDGE

2.

GROSS		10000
kg		
PRESET	NOTES	
kg		
CUSTOMER		
SUPPLIER		
MATERIAL		
VEHICLE	FREE PLATE	
→0←		→0←
1. WEIGH	2. WEIGH	PRINT >>



3.

Select first weigh	
ID=	↑
1. WEIGH=	35000 kg 25/01 10:00
...	
...	
...	
...	
...	
...	
...	↓
Esc	ID



4.

GROSS		10000
kg		
1. TK (kg)	15000	2. TK (kg)
TR: 20000kg		TR: 10000
NET		
kg		
NOTE 1	NOTE 2	
CUSTOMER	SUPPLIER	
MATERIAL	VEHICLE	
Esc ← OK		



5.

i Repeat the same operations carried out in the first weighing from point 3 to point 6.

6.

GROSS		10000
kg		
1. TK (kg)	15000	2. TK (kg)
TR: 20000kg		TR: 5000kg
NET		
kg		
NOTE 1	NOTE 2	
CUSTOMER	SUPPLIER	
MATERIAL	VEHICLE	
Esc ← OK		



7.

DINI ARCEO Scales - Weighing systems	
ID:	1
CUSTOMER	
SUPPLIER	
MATERIAL	
VEHICLE	
SCALE	
05/04/2016 16:00	
PROGRESSIVE	2

1. WEIGH	
TRUCK	15000kg
TRAILER	20000kg

2. WEIGH	
TRUCK	10000kg
TRAILER	5000kg

NET	20000kg

8.

GROSS		0
kg		



WEIGHBRIDGE

Multiple weighing of vehicles with trailer on two weighbridges

USE	Lets you weigh a vehicle with trailer using two weighbridges, performing the weighing in a single operation.
ACTIVATION	Activation requires advanced configuration.

PREMISE

- The scale weighs the traction unit first, then it weighs the trailer.
- Before acquiring the weigh, verify that the selected weighbridge is the correct one (B-4).

Registration procedure of the first weighing

- 1.
2. Press 1.WEIGH to weigh the traction unit
- 3.

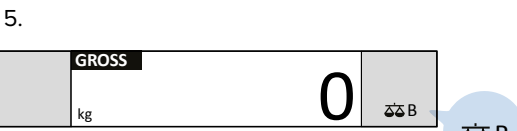
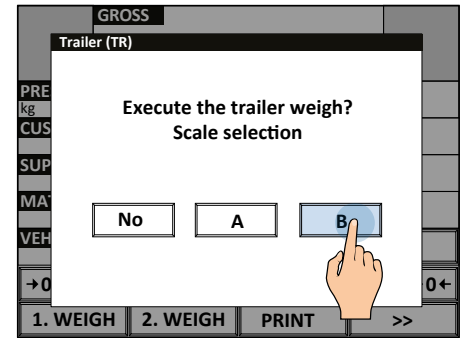
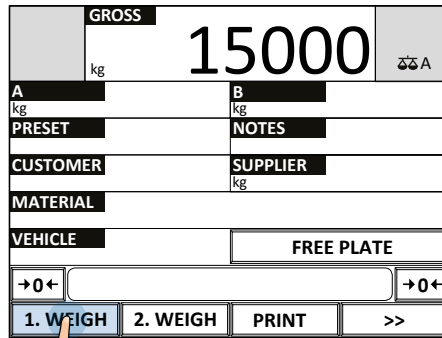
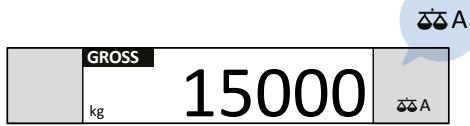

Registration procedure of the second weighing

- 1.
- 2.
- 3.

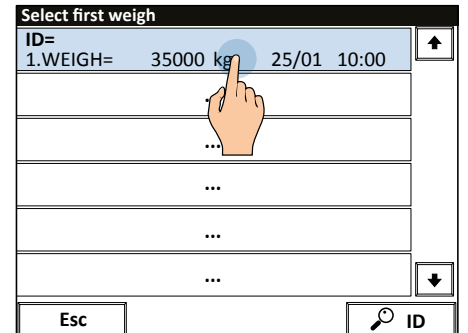
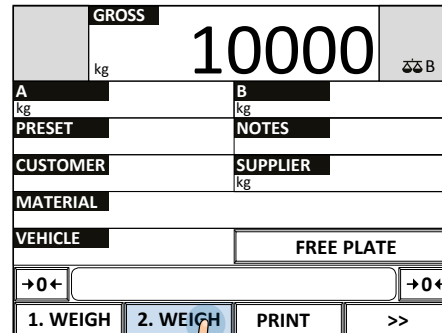
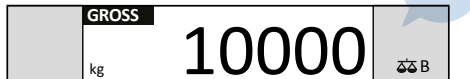

4.

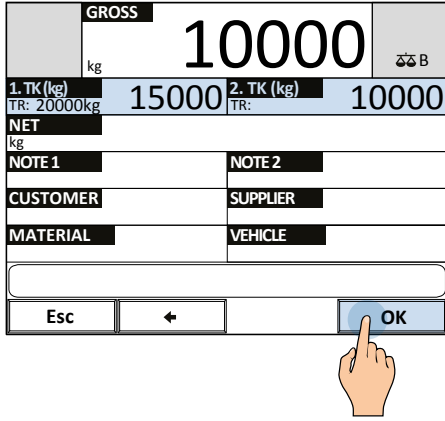

5.

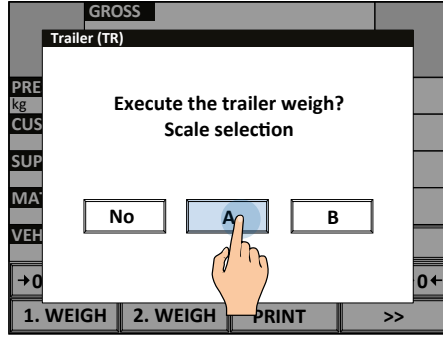

6.

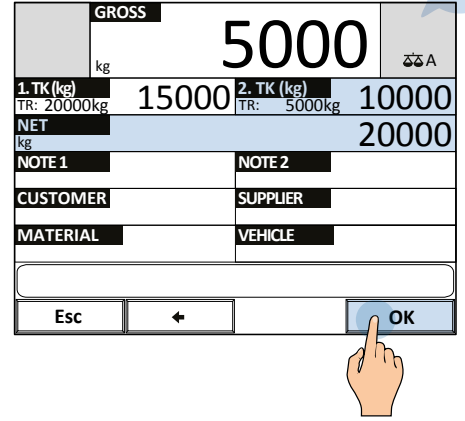

7.

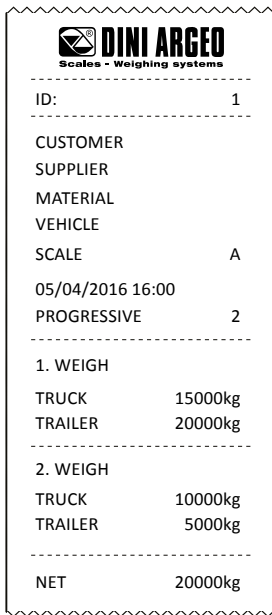

8.

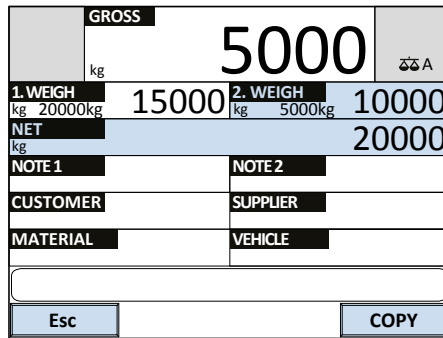

9.

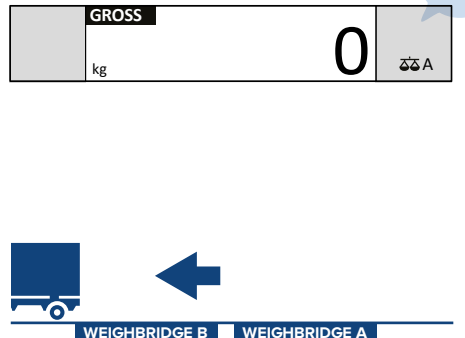

i

You must select the weighbridge on which to weigh the truck before pressing button "1. WEIGH" or "2. WEIGH", in this way the weighbridge may be used in both directions as required.

i

This weighing procedure also lets you weigh two different materials transported by the same vehicle.

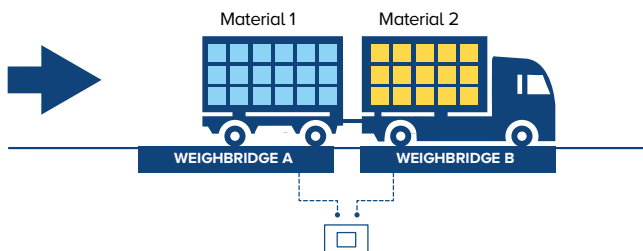

Any printouts with specific net weight of each material require advanced configuration.

“A + B” operating mode with two weighbridges

USE	Lets you add up the weight on the two weighbridges A and B and quickly carry out weighing.
ACTIVATION	Activation requires advanced configuration.

PREMISE

In this operating mode the screen is as follows:

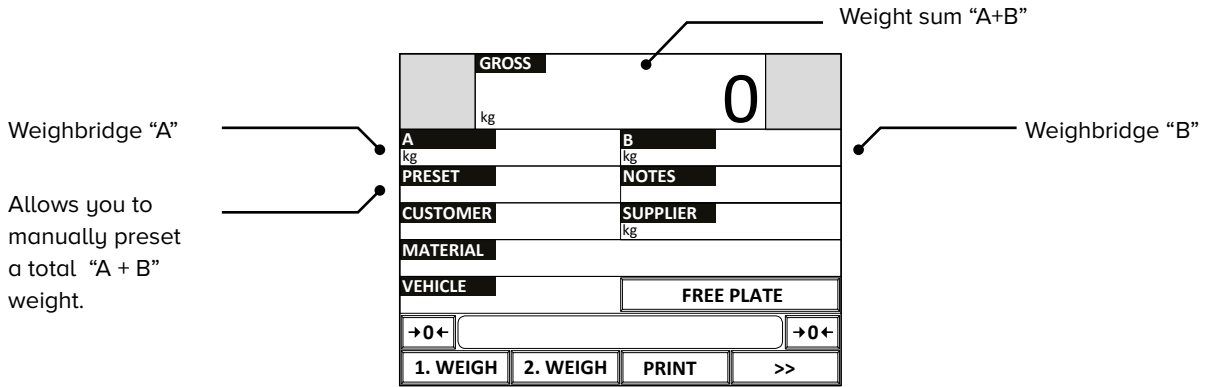

The weighing mode “A + B” allows

Application 1

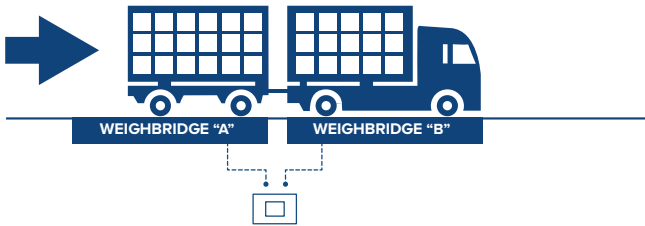

Application 2

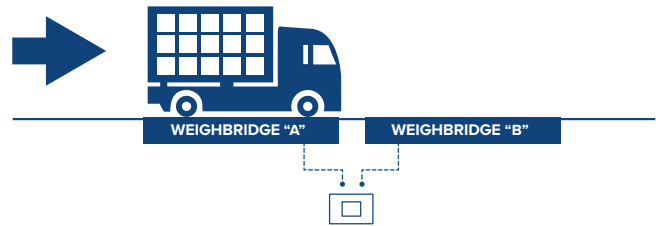

Application 3

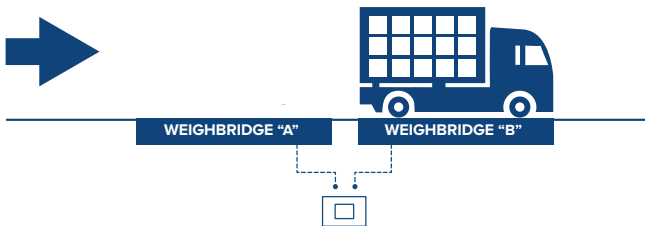

i In the “A+B” operating mode weighing is performed using the sum of “A” + “B”.

Manual entry of the first weighing (preset weigh)

USE	Lets you enter the value of the first weighing manually.
ACTIVATION	Standard active function.

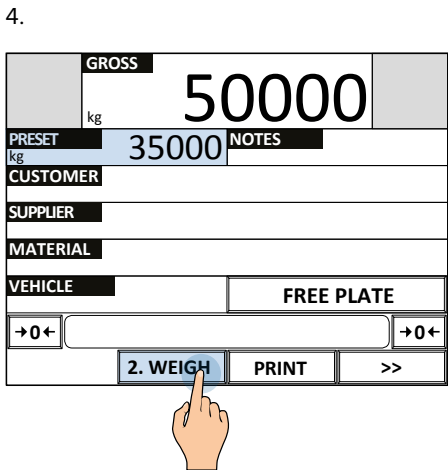
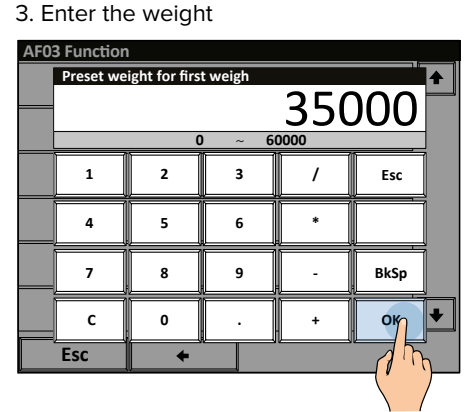
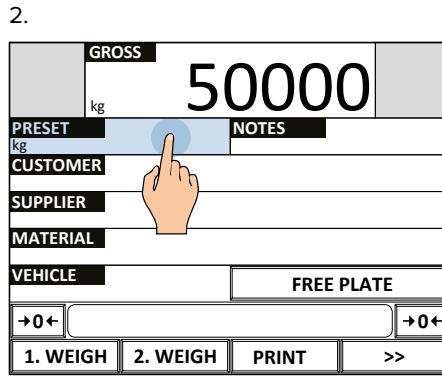
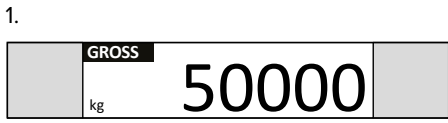

Bringing up the function from the menu

1.

GROSS	50000
kg	



2.

GROSS	50000
kg	
PRESET	NOTES
kg	
CUSTOMER	
SUPPLIER	
MATERIAL	
VEHICLE	FREE PLATE
+0<	+0<
1. WEIGH	2. WEIGH
PRINT	>>

3. Enter the license plate of the vehicle

GROSS	50000
kg	
CUSTOMERS	SUPPLIERS
MATERIALS	VEHICLES
MENU	INPUT TEXT
+0<	+0<
1. WEIGH	2. WEIGH
PRINT	>>

4.

User setup
...
...
...
AF03 Functions
...
...
Esc

5.

AF03 Function
...
...
...
Preset weight for first weigh
...
...
Esc

6. Enter the weight

AF03 Function
Preset weight for first weigh
35000
0 ~ 60000
1 2 3 / Esc
4 5 6 *
7 8 9 - BkSp
C 0 . + Ok
Esc

7.

GROSS	50000
kg	
PRESET	35000
kg	NOTES
CUSTOMER	
SUPPLIER	
MATERIAL	
VEHICLE	FREE PLATE
+0<	+0<
2. WEIGH	PRINT
	>>

8.

DINI ARGEO Scales - Weighing systems	
ID	
CUSTOMER	
SUPPLIER	
MATERIAL	
VEHICLE	
SCALE	
05/04/2016 16:00	
PROGRESSIVE	1
1. WEIGH *	35000kg
2. WEIGH	50000kg
NET*	15000kg
* PRESET WEIGH	

Second weighing by reading the barcode

USE	Speeds up retrieval of the first weighing by reading a barcode.
ACTIVATION	Activation requires advanced configuration.

Example of operation with printing of the ID in the form of barcode

Registration procedure of the first weighing

1.



2.

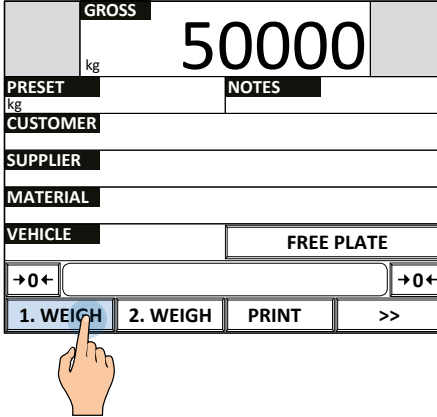

3. Enter the license plate of the vehicle

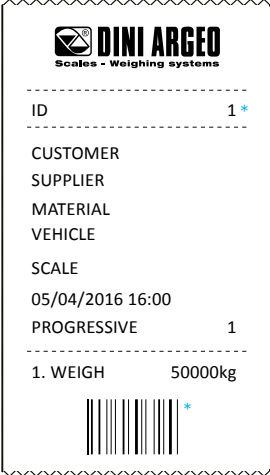

* The ID is also printed in the form of barcode

Registration procedure of the second weighing

1.

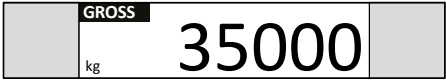

2.

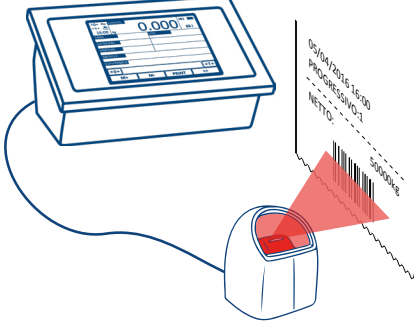

3. The second weighing is performed automatically, with summary receipt printing.

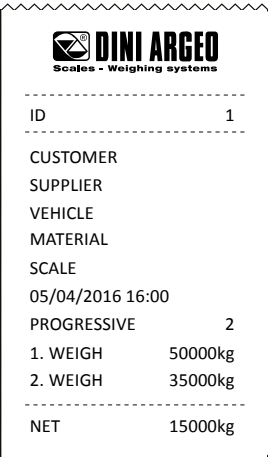

4. Now it is possible to print one or more copies of the receipt, or unload the weighbridge / press ESC to return to weighing mode.

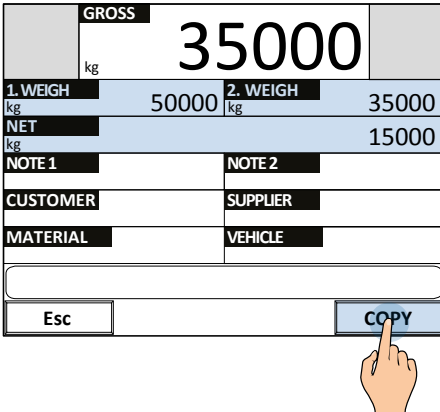

This operation can be applied in the following systems:

Single weigh

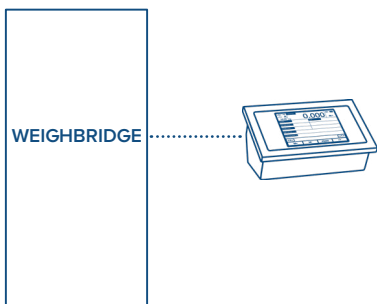

Two networked weighbridges

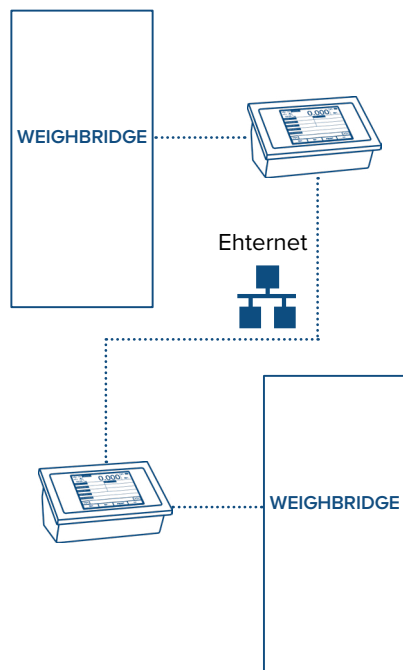

Two independent weighbridges

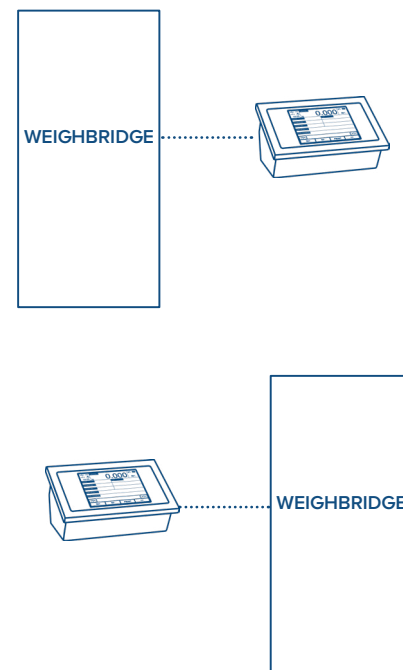

The main advantages are:

- speed up the selection of the first recorded weighing in memory;
- eliminate possible selection errors.

i The operation entails printing the ID in the form of barcode.

The main advantages are:

- eliminate possible typing errors by the driver;
- automate the second weighing without the need to connect the two weighbridges in a network.

i The operation entails printing the weight in the form of barcode, hence the first weight will be marked in print with an asterisk (*) and the designation of "PRESET WEIGH".

Instrument networking for database and weighings sharing

USE	It lets you perform the first weighing on an instrument and the second on another in the network, speeding up operations. All databases are shared and updated in real time on all the instruments of the network.
ACTIVATION	Activation requires advanced configuration.

Application diagram

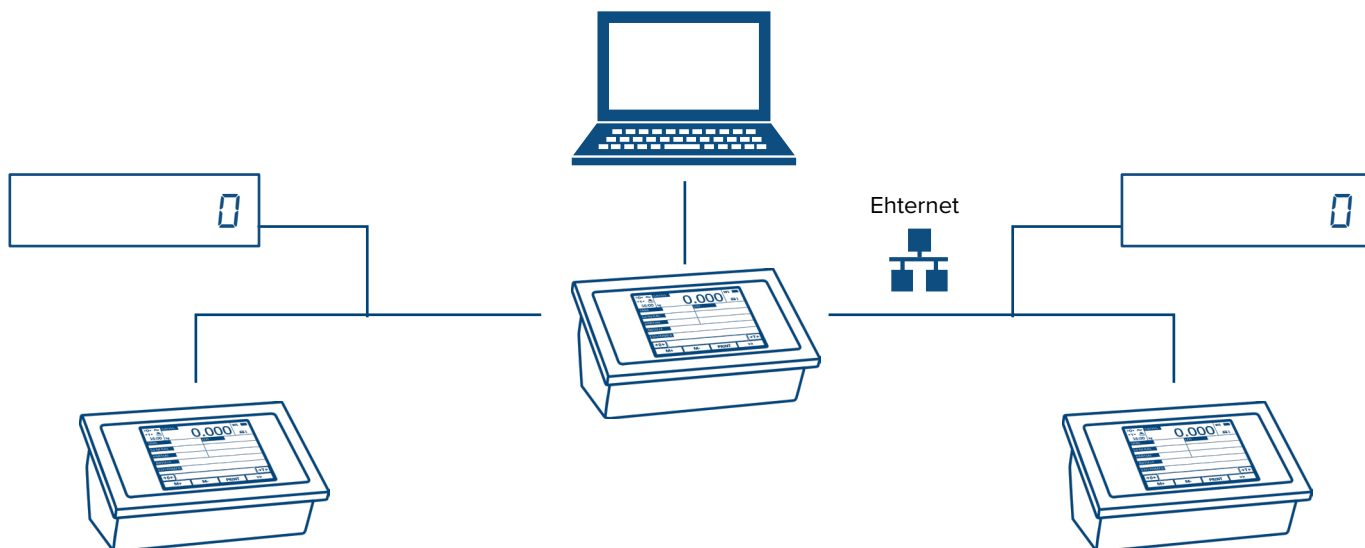

Example 1

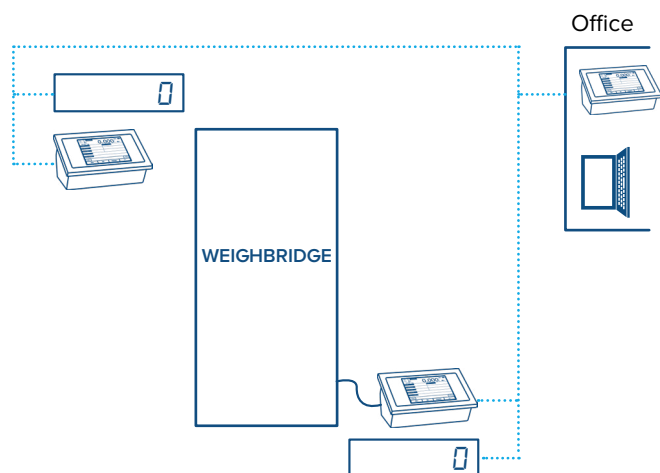

Example 2

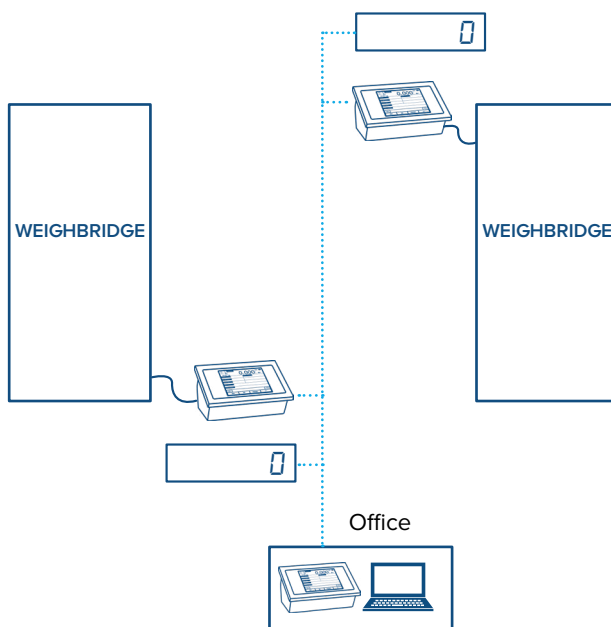

Management of barriers and traffic lights

USE	The weighing indicator is arranged for installation of inputs and outputs for managing automations that govern access to the weighbridge (barriers, traffic lights, etc.).
ACTIVATION	Activation requires advanced configuration.

Application example

1. Weighbridge ready

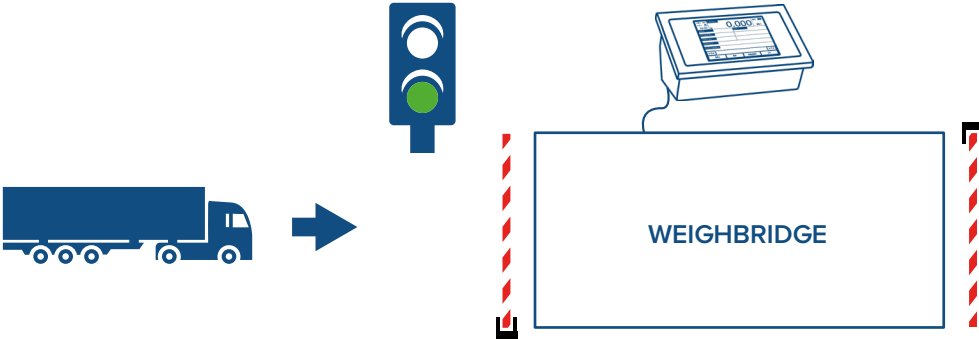

2. Vehicle identification (via RFID or sensors)

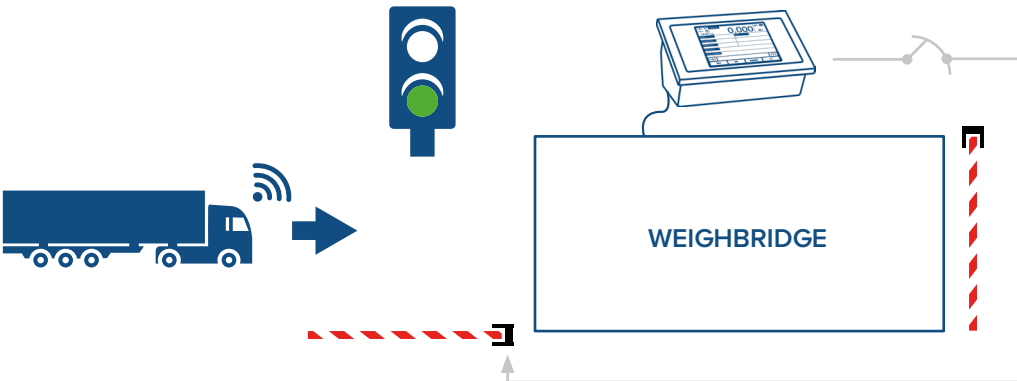

3. Weighing in progress



4. Successfully executed weighing

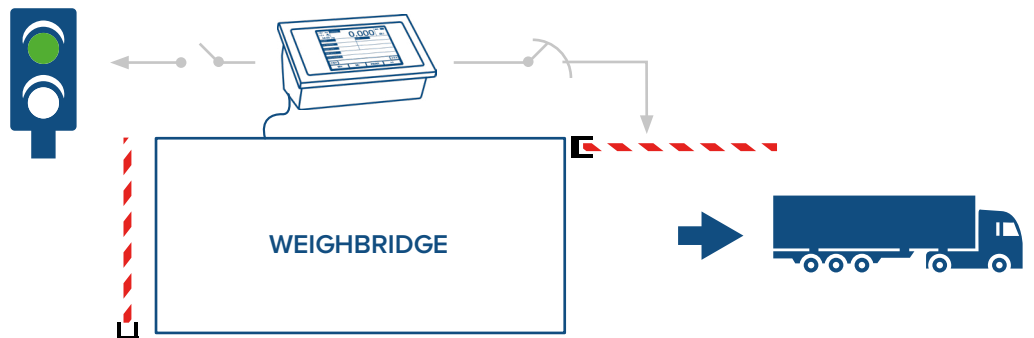

Weighing with axle control

USE	It lets you check the weight of each axle during the second weighing to prevent overloading and subsequent fines. The weight of the axles can be shown in the printout.
ACTIVATION	Activation requires advanced configuration.

The acquisition of the axles is automatic and occurs dynamically while the vehicle climbs onto the weighbridge.

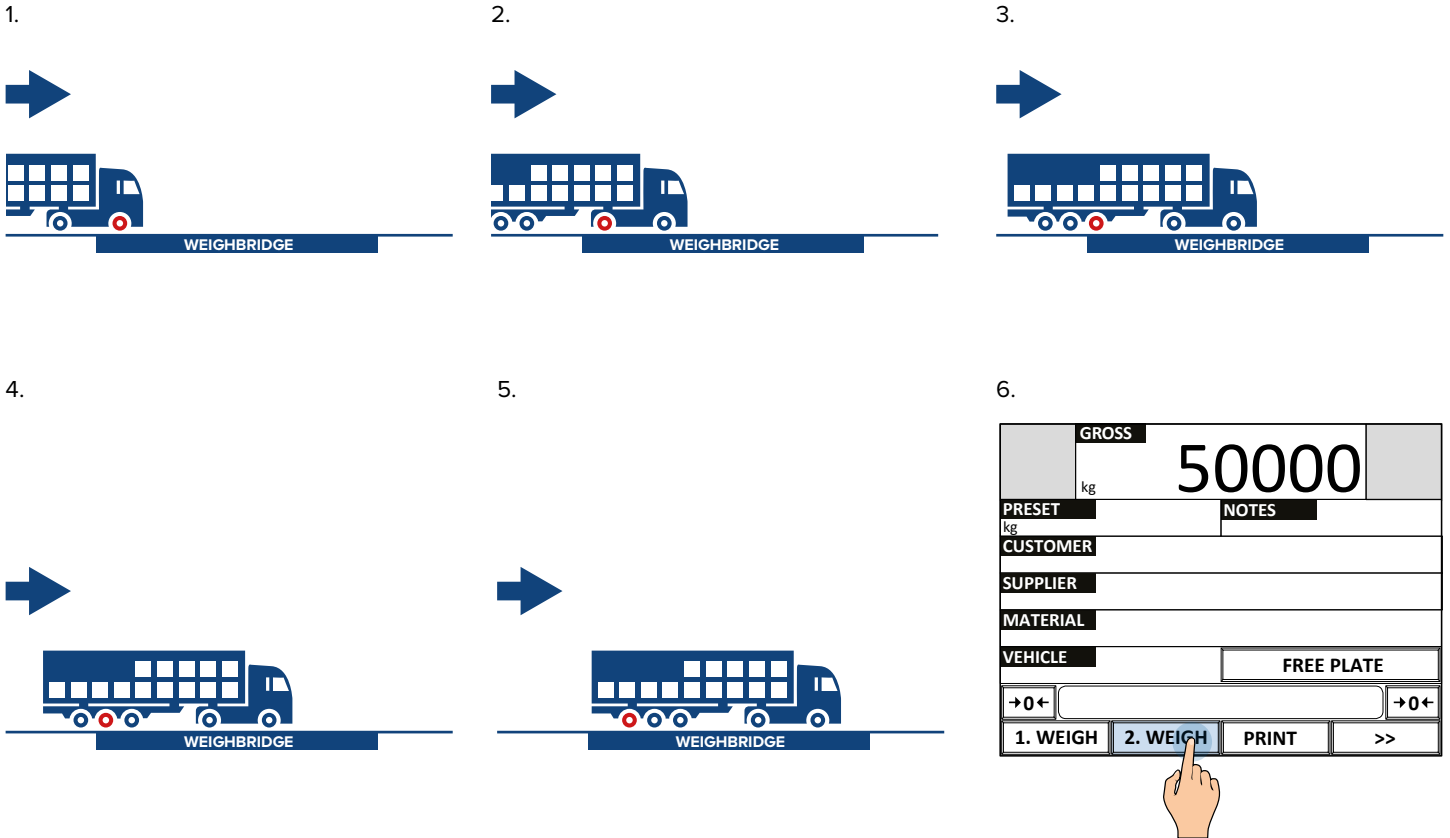

7.

Select first weigh		
ID=		
1.WEIGH=	35000 kg	25/01 10:00
	...	
	...	
	...	
	...	
	...	

Esc ID

8.

GROSS	
kg	50000
1. WEIGH	35000
kg	
2. WEIGH	50000
kg	
NET	
kg	
NOTE 1	NOTE 2
CUSTOMER	SUPPLIER
MATERIAL	VEHICLE

Esc ← OK

9.

DINI ARGEO	
Scales - Weighing systems	
ID	
CUSTOMER	
SUPPLIER	
MATERIAL	
VEHICLE	
SCALE	A
05/04/2016 16:00	
PROGRESSIVE	1
1. AXLE	6000kg
2. AXLE	8500kg
3. AXLE	10000kg
4. AXLE	14000kg
5. AXLE	11500kg
1. WEIGH	35000kg
2. WEIGH	50000kg
NET	15000kg

Reissue of closed weighing

USE	Lets you re-edit a closed multiple weighing in order to execute the second weighing again.
ACTIVATION	Standard active function. Can be used if there is at least one weigh open and using identification mode by progressive ID.

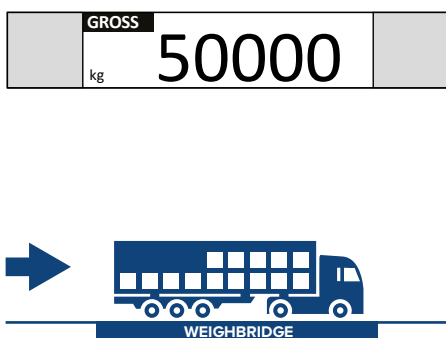
1. 

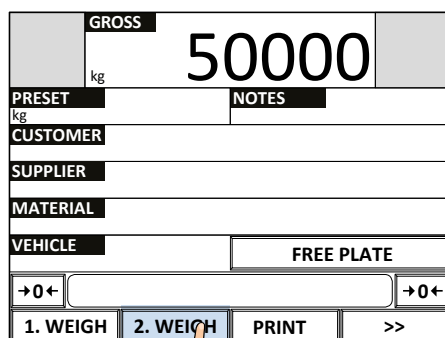
2. 

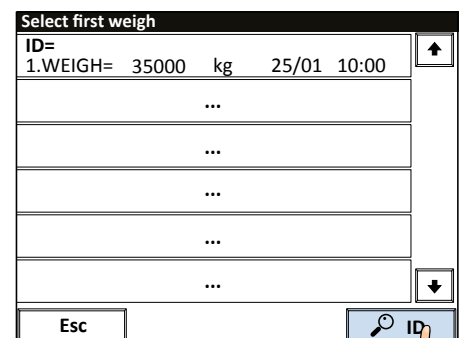
3. 

4. Type the ID of the weighing to be reedited.

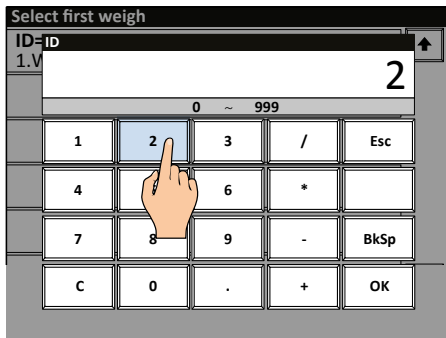

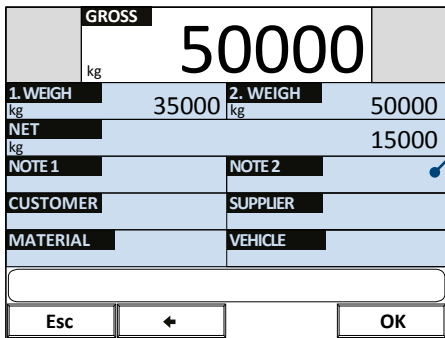
5. 

i The function retrieves all the weight data and the records selected in the first weighing speeding up operations.

List of weighings performed

USE	Lets you reference, reprint or delete a weighing in progress or closed.
ACTIVATION	The function is active as standard.

How to access the list

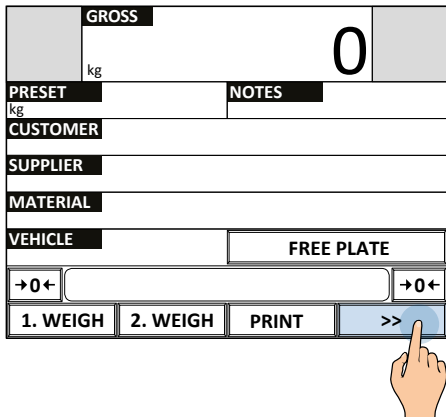
1. 

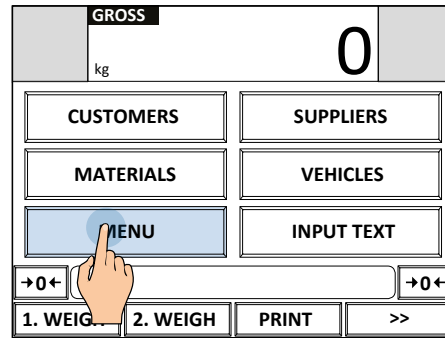
2. 

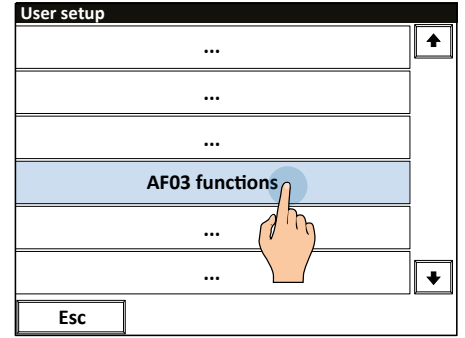
3. 

4.

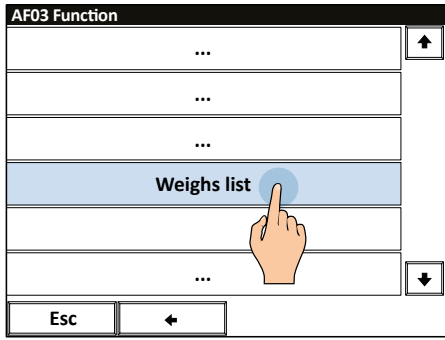

5. Choose whether to show only open / closed weighings or search the weighing by numberplate / ID.

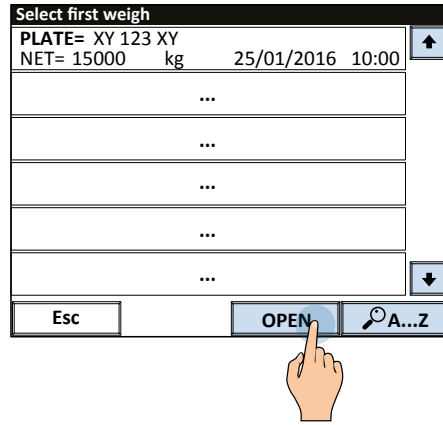

6.

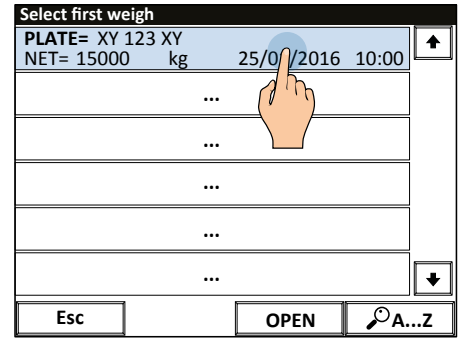

7. It is possible to print a summary copy of the selected weighing or delete it.

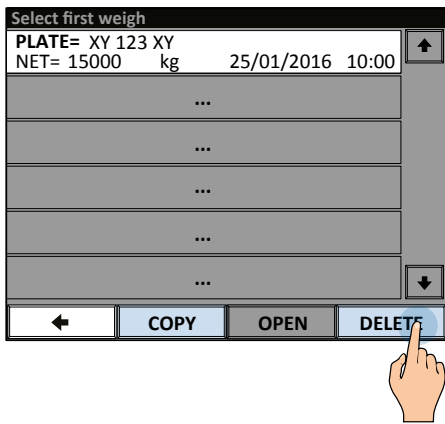

How to clear the list of weighings

1.

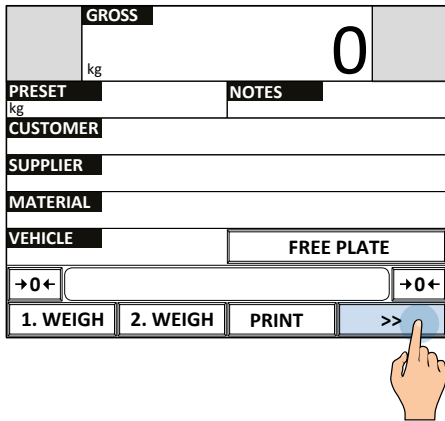

2.

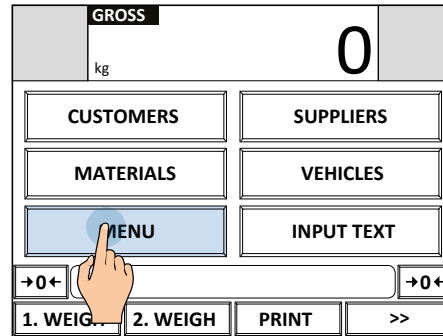

3.

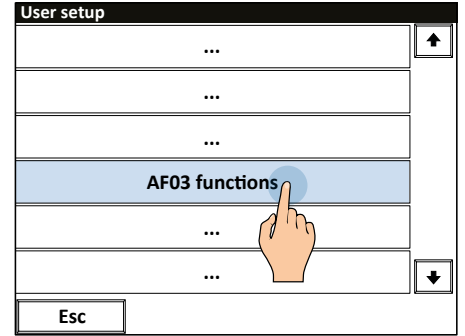

4.

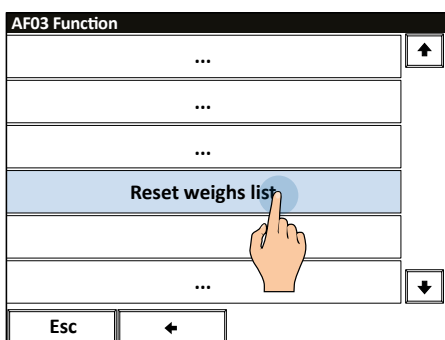

5.

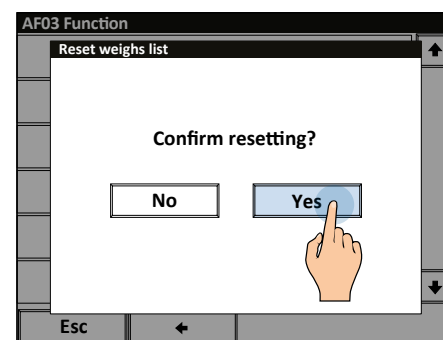

General weighing functions

Resetting the weight

USE	Lets you reset the zero before weighing, for optimal weighings.
APPLICATIONS	General weighing.
ACTIVATION	Standard active function.

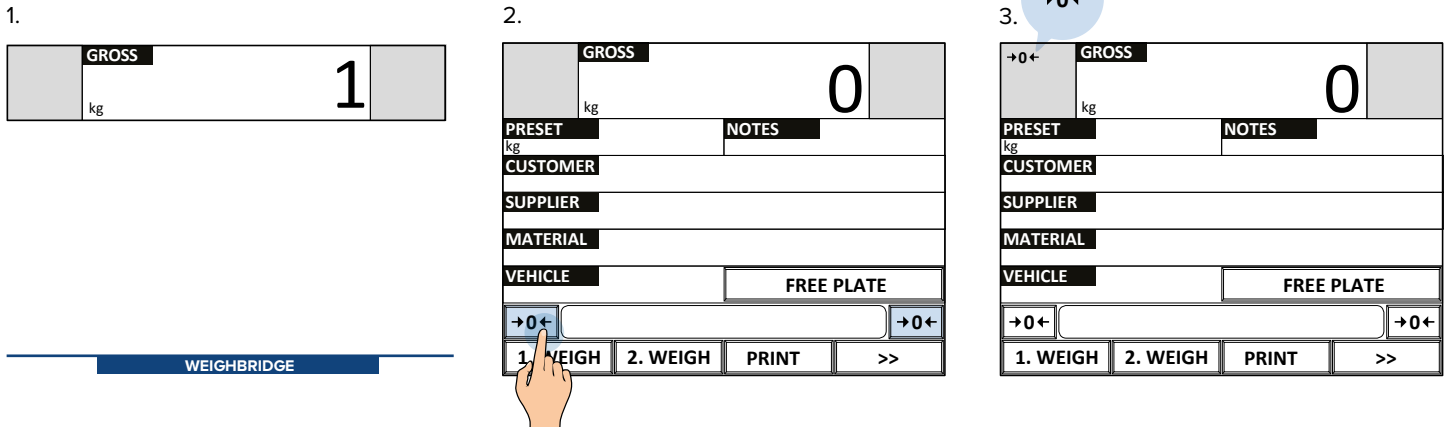

i The allowed zero setting range is equivalent to +/-2% of the maximum capacity of the weighbridge.

Weight view zoom

USE	You can enlarge the weight at any time for comfortable reading even at a great distance.
APPLICATIONS	General weighing.
ACTIVATION	Standard active function.

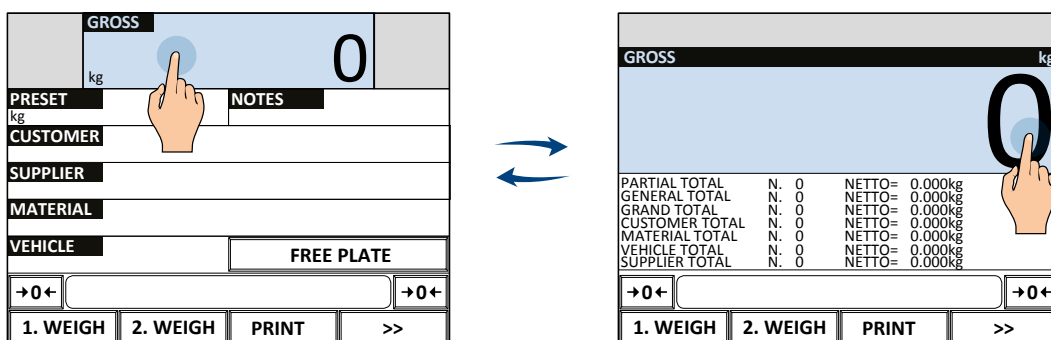

High resolution weight

USE	Allows you to display the weight with 10 times greater resolution.
APPLICATIONS	Checks for internal use.
ACTIVATION	Standard active function.

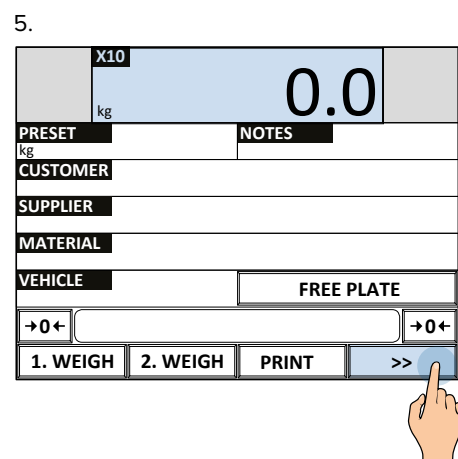
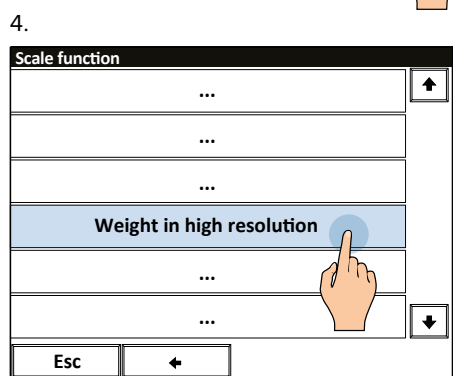
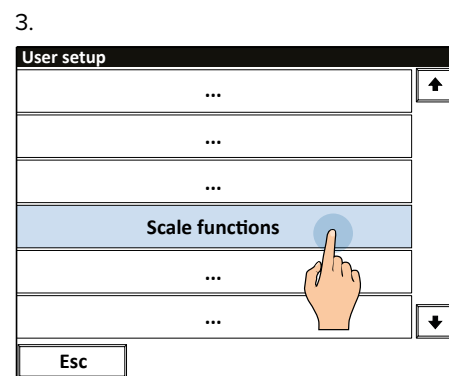
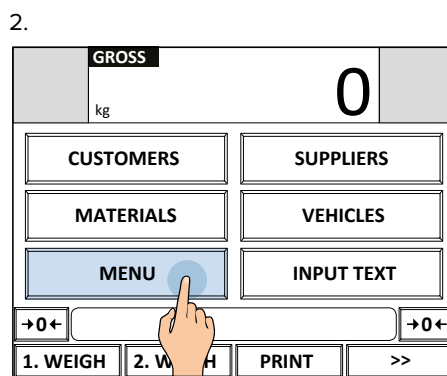
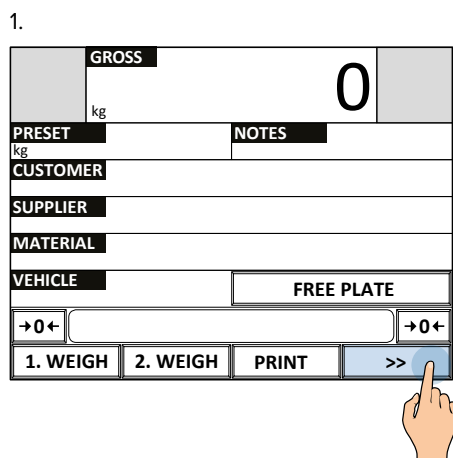

i If the instrument is approved, the display remains for a few seconds, then deactivates automatically.

Calculator

USE	Perform operations and print the total.
ACTIVATION	Standard active function.

To call up the generic “calculator” function:

1.

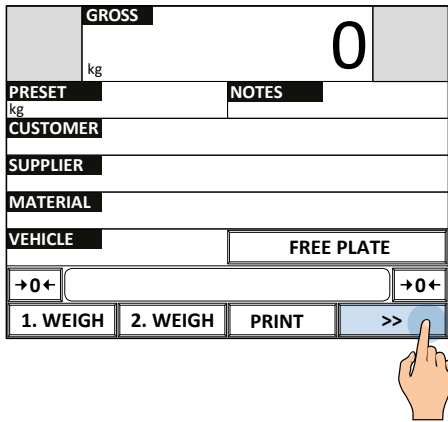

2.

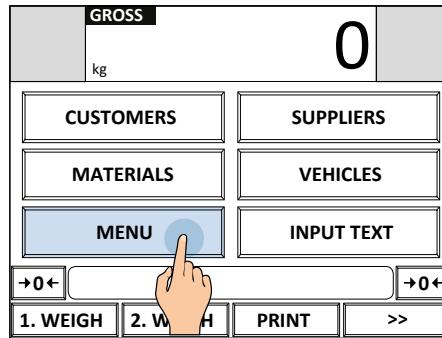

3.

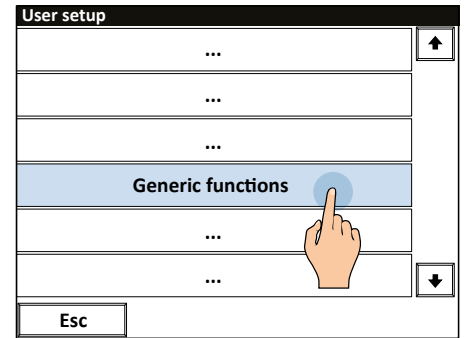

4.

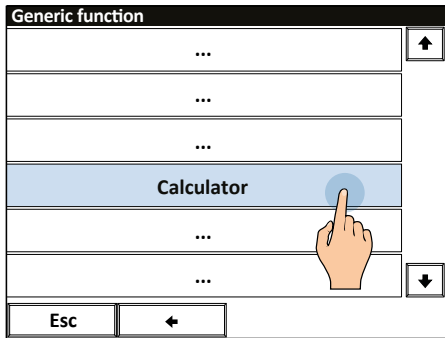

5.

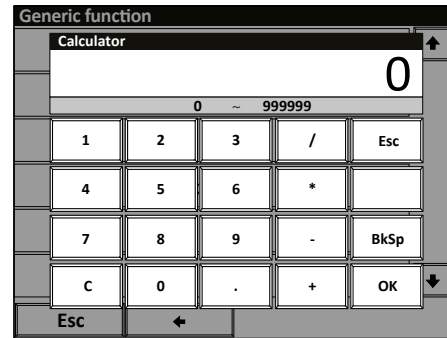

Operation with several scales

USE	The instrument can handle up to 4 analogue or digital scales as standard.
APPLICATIONS	General weighing.
ACTIVATION	Standard active function if two scales or more present.

Select the weighbridge required to weigh

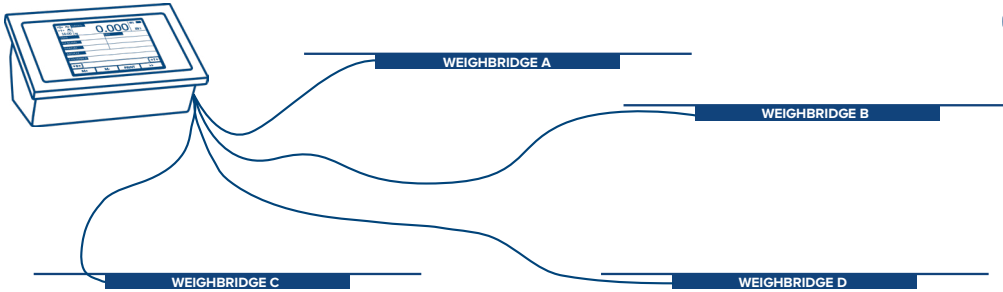

i The indicator is standard designed to connect up to 4 scales with different capacities and accuracies.

GROSS		0	⚙️ A
A	B		
kg	kg		
C	D		
kg	kg		
CUSTOMER	SUPPLIER		
	kg		
MATERIAL			
VEHICLE		FREE PLATE	
→0←			→0←
1. WEIGH	2. WEIGH	PRINT	>>

GROSS		0	⚙️ B
A	B		
kg	kg		
C	D		
kg	kg		
CUSTOMER	SUPPLIER		
	kg		
MATERIAL			
VEHICLE		FREE PLATE	
→0←			→0←
1. WEIGH	2. WEIGH	PRINT	>>

GROSS		0	⚙️ C
A	B		
kg	kg		
C	D		
kg	kg		
CUSTOMER	SUPPLIER		
	kg		
MATERIAL			
VEHICLE		FREE PLATE	
→0←			→0←
1. WEIGH	2. WEIGH	PRINT	>>

GROSS		0	⚙️ D
A	B		
kg	kg		
C	D		
kg	kg		
CUSTOMER	SUPPLIER		
	kg		
MATERIAL			
VEHICLE		FREE PLATE	
→0←			→0←
1. WEIGH	2. WEIGH	PRINT	>>

GROSS		0	⚙️ S
A	B		
kg	kg		
C	D		
kg	kg		
CUSTOMER	SUPPLIER		
	kg		
MATERIAL			
VEHICLE		FREE PLATE	
→0←			→0←
1. WEIGH	2. WEIGH	PRINT	>>

i The features available in a multiple weighbridge configuration are:

- Truck + trailer (see page A-6)
- A+B (see page A-10)
- A+B+C+D

500 Customers / 250 suppliers database

USE	Allows you to save the records of 500 customers / 250 different suppliers.
APPLICATIONS	Traceability, consumption and production checking, inventory monitoring.
ACTIVATION	Standard active function.

How to fill in the database

1.

kg 0

PRESET kg NOTES

CUSTOMER

SUPPLIER

MATERIAL

VEHICLE FREE PLATE

→0← →0←

1. WEIGH 2. WEIGH PRINT >>

2.

kg 0

CUSTOMERS SUPPLIERS

MATERIAL VEHICLES

MENU INPUT TEXT

→0← →0←

1. WEIGH 2. WEIGH PRINT >>

3.

Customer dtb

0001	Empty
0002	Empty
0003	Empty
0004	Empty
0005	Empty
0006	Empty
0007	Empty
0008	Empty

Esc NEW 🔍 A...Z >>

Once you enter the customer / supplier database filling menu you can:

Enter a new record

1.

Customer dtb

0001	Empty
0002	Empty
0003	Empty
0004	Empty
0005	Empty
0006	Empty
0007	Empty
0008	Empty

Esc NEW 🔍 A...Z >>

2. Fill in the fields.

Customer 0001/0499

Description 1	
Description 2	
Description 3	

← DELETE

3. Saving is automatic

Customer 0001/0499

Description 1	WHITE LTD
Description 2	
Description 3	

← DELETE

Delete a record

1.

Customer dtb

0001	WHITE LTD
0002	Empty
0003	Empty
0004	Empty
0005	Empty
0006	Empty
0007	Empty
0008	Empty

Esc NEW 🔍 A...Z >>

2.

Customer 0001/0499

Description 1	WHITE LTD
Description 2	
Description 3	

← DELETE

3.

Customer 0001/0499

Delete the record?

No Yes

← DELETE

Edit an existing record

1.

Customer dtb	
0001	WHITE LTD
0002	Empty
0003	Empty
0004	Empty
0005	Empty
0006	Empty
0007	Empty
0008	Empty

Esc NEW A...Z >>

2.

Customer 0001/0499	
Description 1	WHITE LTD
Description 2	
Description 3	

← DELETE

3. Saving is automatic

Description 2									
JOHN WHITE									
Esc	'	<	/]	Clear	BkSp			
1	2	3	4	5	6	7	8	9	0
Q	W	E	R	T	Y	U	I	O	P
A	S	D	F	G	H	J	K	L	;
2 [^] _F	Z	X	C	V	B	N	M	,	.
Shift	←					→	OK		

Search a record to edit / delete by alphabetic selection.

1.

Customer dtb	
0001	WHITE LTD
0002	Empty
0003	Empty
0004	Empty
0005	Empty
0006	Empty
0007	Empty
0008	Empty

Esc NEW A...Z >>

2.

Customer									
WHITE LTD	↑ ↓								
	CLEAR								
	BkSp								
W									
Q	W	E	R	T	Y	U	I	O	P
A	D	F	G	H	J	K	L	;	
2 [^] _F	X	C	V	B	N	M	Esc		
Shift									NEW

Search a record by its numeric index

1.

Customer dtb	
0001	WHITE LTD
0002	Empty
0003	Empty
0004	Empty
0005	Empty
0006	Empty
0007	Empty
0008	Empty

Esc NEW A...Z >>

2.

Customer dtb	
0001	WHITE LTD
0002	Empty
0003	Empty
0004	Empty
0005	Empty
0006	Empty
0007	Empty
0008	Empty

HELP PRINT INDEX >>

3. Enter the index of the record and press OK to confirm

Customer dtb									
Select record									
1									
1 ~ 999									
1	2	3	/	Esc					
4	5	6	*						
7	8	9	-	BkSp					
C	0	.	+	OK					
HELP	PRINT	INDEX							

Select a record

1.

GROSS	0		
kg			
PRESET	NOTES		
kg			
CUSTOMER			
SUPPLIER			
MATERIAL			
VEHICLE	FREE PLATE		
→0←	→0←		
1. WEIGH	2. WEIGH	PRINT	>>

2.

Customer dtb	
0001	WHITE LTD
0002	Empty
0003	Empty
0004	Empty
0005	Empty
0006	Empty
0007	Empty
0008	Empty

Esc NEW A...Z >>

3.

GROSS	0		
kg			
PRESET	NOTES		
kg			
CUSTOMER			
WHITE LTD			
SUPPLIER			
MATERIAL			
VEHICLE	FREE PLATE		
→0←	→0←		
1. WEIGH	2. WEIGH	PRINT	>>

Clear the current record

1.

GROSS		0	
PRESET	kg	NOTES	
CUSTOMER			
SMIDTH LTD			
SUPPLIER			
MATERIAL			
VEHICLE		FREE PLATE	
+0←			→0+
1. WEIGH	2. WEIGH	PRINT	>>

2.

Select customer	
0000	Temporary
0001	SMIDTH LTD
0002	BLACK LTD
0003	GRAY LTD
0004	ORANGE LTD
0005	Vuoto
0006	Vuoto
0007	Vuoto

Selected customer: 0001

Esc DESELECT A...Z INDEX



3. Press YES to clear the record

GROSS		Customer 0001/0499	
PRE	kg	Deselect the record?	
CUS		No	Yes
SUP			
MA			
VEH			
+0←			0+
1. WEIGH	2. WEIGH	PRINT	>>

Fields of customer / supplier database

USE	Allow you to associate to each customer / supplier helpful descriptions to identify them in print and combine with specific functions.
APPLICATIONS	Customer traceability / recognition
ACTIVATION	In the default factory configuration, the customer / supplier fields are all active and you can disable the unused fields to make it easier to enter new records. Disabling requires advanced configuration.

Alphanumeric descriptions of 25 characters each that identify the customer / supplier.

Customer 0001/0499	
Description 1	
Description 2	
Description 3	
←	DELETE

500 materials database

USE	Lets you store up to 500 different materials.
APPLICATIONS	Traceability / Order management / Customer management.
ACTIVATION	Standard active function

How to fill in the database

1.

kg 0

PRESET kg NOTES

CUSTOMER

SUPPLIER

MATERIAL

VEHICLE FREE PLATE

→0← →0←

1. WEIGH 2. WEIGH PRINT >>

2.

kg 0

CUSTOMERS SUPPLIERS

MATERIALS VEHICLES

MENU INPUT TEXT

→0← →0←

1. WEIGH 2. WEIGH PRINT >>

3.

Material dtb	
0001	Empty
0002	Empty
0003	Empty
0004	Empty
0005	Empty
0006	Empty
0007	Empty
0008	Empty

Esc NEW 🔍 A...Z >>

Once you enter the material database filling menu you can:

Enter a new material

1.

Material dtb	
0001	Empty
0002	Empty
0003	Empty
0004	Empty
0005	Empty
0006	Empty
0007	Empty
0008	Empty

Esc NEW 🔍 A...Z >>

2. Fill in the fields.

Material 0008 / 0499

Description 1	
Description 2	

← DELETE

3. Saving is automatic

Material 0008 / 0499

Description 1	CLAY
Description 2	

← DELETE

Delete a material

1.

Material dtb	
0001	KAOLIN
0002	CLAY
0003	SAND
0004	GRAVE
0005	OTHER
0006	EMPTY
0007	EMPTY
0008	EMPTY

Esc NEW 🔍 A...Z >>

2.

Material 0002 / 0499

Description 1	Clay
Description 2	

← DELETE

3.

Material dtb

Material 0001/0499

Delete the record?

No Yes

Esc NEW 🔍 A...Z >>

Edit an existing material

1.

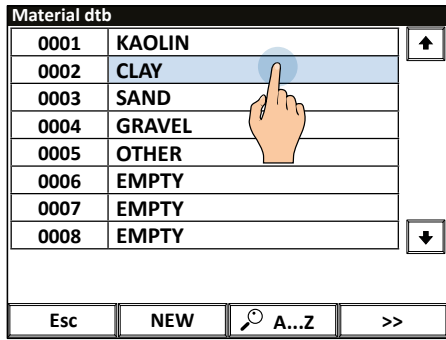

2.

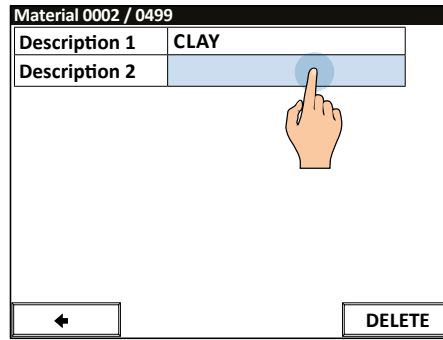

3. Saving is automatic

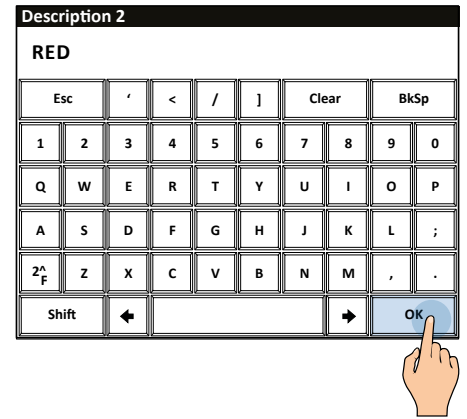

Look for a material to edit/delete via alphabetic selection.

1.

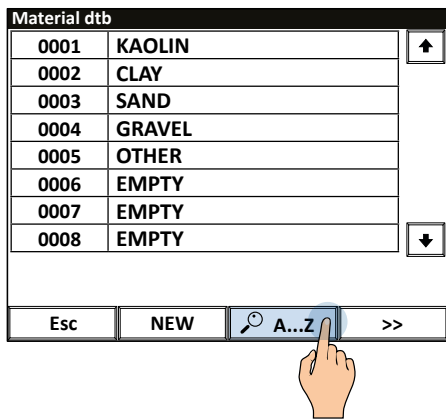

2.

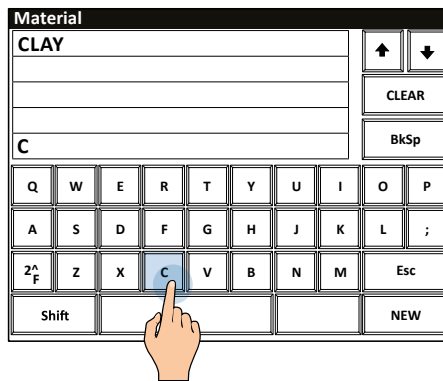

Look for a material by its numeric index

1.

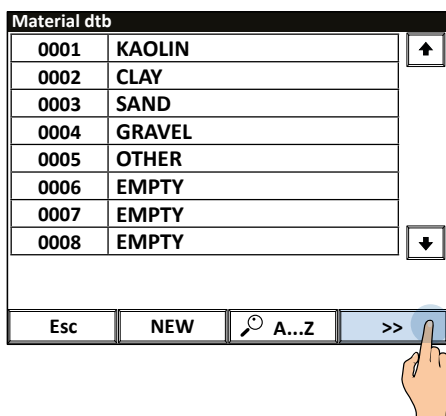

2.

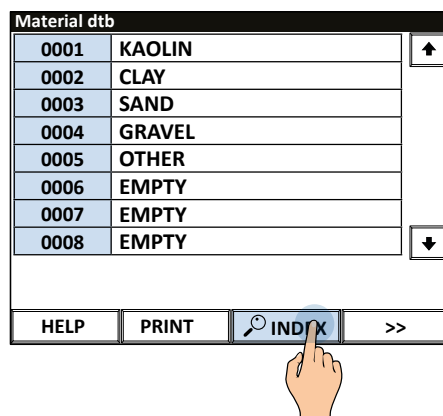

3. Enter the index of the material and press OK to confirm

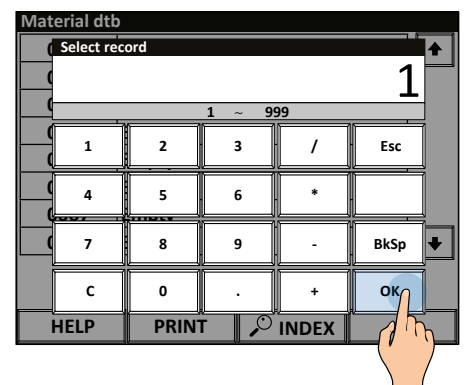

Select a material

1.

GROSS		0	
kg			
PRESET	NOTES		
kg			
CUSTOMER			
SUPPLIER			
MATERIAL			
VEHICLE	FREE PLATE		
+0<			>0+
1. WEIGH	2. WEIGH	PRINT	>>

2.

Material dtb			
0001	KAOLIN		↑
0002	CLAY		
0003	SAND		
0004	GRAVEL		
0005	OTHER		
0006	EMPTY		
0007	EMPTY		
0008	EMPTY		↓
Esc	NEW	A...Z	>>

3.

GROSS		0	
kg			
PRESET	NOTES		
kg			
CUSTOMER			
SUPPLIER			
MATERIAL	KAOLIN		
VEHICLE	FREE PLATE		
+0<			>0+
1. WEIGH	2. WEIGH	PRINT	>>

Clear the current material

1.

GROSS		0	
kg			
PRESET	NOTES		
kg			
CUSTOMER			
SUPPLIER			
MATERIAL	KAOLIN		
VEHICLE	FREE PLATE		
+0<			>0+
1. WEIGH	2. WEIGH	PRINT	>>

2.

Select material			
0000	TEMPORARY		↑
0001	KAOLIN		
0002	CLAY		
0003	SAND		
0004	GRAVEL		
0005	OTHER		
0006	EMPTY		
0007	EMPTY		↓
Selected material: 0001			
Esc	DESELECT	A...Z	INDEX

3. Press YES to clear the customer

Select material			
Material 0001/0499			
Deselect the record?			
No		Yes	
Esc DESELECT A...Z INDEX			

Fields of materials database

USE	Allow you to associate descriptions to each material to help to identify it in print and combine it with specific functions.
APPLICATIONS	Material traceability / recognition.
ACTIVATION	In the default factory configuration, the material fields are all active and you can disable the unused fields to make it easier to enter new records. Disabling requires advanced configuration.

Alphanumeric descriptions of 20 characters each that identify the material.

Material 0002 / 0499	
Description 1	
Description 2	
←	
DELETE	

500 vehicles database

USE	Lets you store up to 500 different vehicles.
APPLICATIONS	Traceability / Order management / Customer management.
ACTIVATION	Standard active function

How to fill in the database

-
-
-

Once you enter the vehicle database filling menu you can:

Enter a new vehicle

-
-
-

Delete a vehicle

-
-
-

Edit an existing vehicle

1.

Vehicle dtb	
0001	XX 123 YY
0002	AA 321 BB
0003	AB 456 CD
0004	Empty
0005	Empty
0006	Empty
0007	Empty
0008	Empty

Esc NEW A...Z >>

2.

Vehicle 0001/499	
Plate	AA 321 BB
Description	
Preset	0kg
Trailer weighing	Disabled

← DELETE

3. Saving is automatic

Description									
IVECO									
Esc	'	<	/]	Clear	BkSp			
1	2	3	4	5	6	7	8	9	0
Q	W	E	R	T	Y	U	I	O	P
A	S	D	F	G	H	J	K	L	;
2 [^] _F	Z	X	C	V	B	N	M	,	.
Shift	←					→	OK		

Look for a vehicle to edit / delete via alphabetic selection.

1.

Vehicle dtb	
0001	XX 123 YY
0002	AA 321 BB
0003	AB 456 CD
0004	Empty
0005	Empty
0006	Empty
0007	Empty
0008	Empty

Esc NEW A...Z >>

2.

Vehicle									
AA 321 BB	↑								
AB 456 CD	↓								
CLEAR									
BkSp									
A									
Q	W	E	R	T	Y	U	I	O	P
A	S	D	F	G	H	J	K	L	;
Z	X	C	V	B	N	M	Esc		
NEW									

Look for a vehicle by its numeric index

1.

Vehicle dtb	
0001	XX 123 YY
0002	AA 321 BB
0003	AB 456 CD
0004	Empty
0005	Empty
0006	Empty
0007	Empty
0008	Empty

Esc NEW A...Z >>

2.

Vehicle dtb	
0001	XX 123 YY
0002	AA 321 BB
0003	AB 456 CD
0004	Empty
0005	Empty
0006	Empty
0007	Empty
0008	Empty

HELP PRINT INDEX >>

3. Enter the index of the vehicle and press OK to confirm

Vehicle dtb									
Select record									
1									
1 ~ 999									
1	2	3	/	Esc					
4	5	6	*						
7	8	9	-	BkSp					
C	0	.	+	OK					
HELP	PRINT	INDEX							

Select a vehicle

1.

GROSS		0
kg		
PRESET	NOTES	
kg		
CUSTOMER		
SUPPLIER		
MATERIAL		
VEHICLE	FREE PLATE	
+0+		+0+
1. WEIGH	2. WEIGH	PRINT >>

2.

Vehicle dtb	
0001	XX 123 YY
0002	AA 321 BB
0003	AB 456 CD
0004	Empty
0005	Empty
0006	Empty
0007	Empty
0008	Empty

Esc NEW A...Z >>

3.

GROSS		0
kg		
PRESET	NOTES	
kg		
CUSTOMER		
SUPPLIER		
MATERIAL		
VEHICLE	FREE PLATE	
XX 123 YY		
+0+		+0+
1. WEIGH	2. WEIGH	PRINT >>

Clear the current vehicle

1.

GROSS		0	
kg	NOTES		
PRESET	CUSTOMER		
kg	SUPPLIER		
MATERIAL			
VEHICLE		FREE PLATE	
AA 321 BB			
+0←			→0+
1. WEIGH	2. WEIGH	PRINT	>>

2.

Select Vehicle	
0000	Temporary
0001	AA 321 BB
0002	AB 456 CD
0003	Vuoto
0004	Vuoto
0005	Vuoto
0006	Vuoto
0007	Vuoto

Selected vehicle: 0001

Esc DESELECT A...Z INDEX



3. Press YES to clear the vehicle

Select Vehicle	
Vehicle 0001/0499	
Deselect the record?	
<input type="button" value="No"/> <input type="button" value="Yes"/>	

Esc DESELECT A...Z INDEX

Fields of vehicles database

USE	Allow you to associate descriptions to each vehicle to help to identify it in print and combine it with specific functions.
APPLICATIONS	Vehicle traceability / recognition
ACTIVATION	In the default configuration, all fields are active and you can disable the unused fields to make it easier to enter new records. Disabling requires advanced configuration.

Vehicle license plate, max 20 characters. In the “recognition by numberplate” mode, identifies the first weighing (see page A-2).

Alphanumeric description of 20 characters that can be shown in print.

By no entering a vehicle weight (0kg), there is no need to execute the first weighing, but only the second (see page A-11).



Vehicle 0001/499	
Plate	
Description	
Preset	0kg
Trailer weighing	Disabled

← DELETE

Entering weighing identifier texts

USE	You can enter up to 15 texts to indicate the location and address of the weighbridge, operator or any required data. Such data may be shown in the printout or transmitted to the IT system or saved on USB devices.
APPLICATIONS	Traceability of weighings.
ACTIVATION	The free texts "NOTE 1" and "NOTE 2" are active as standard. Additional text activation (up to 15) requires advanced configuration. Activating an automatic entry sequence (up to 10 consecutive operations) requires advanced configuration (see page G-1)

The indicator is standard supplied with two quick retrieve ID texts: "NOTE 1" and "NOTE 2".

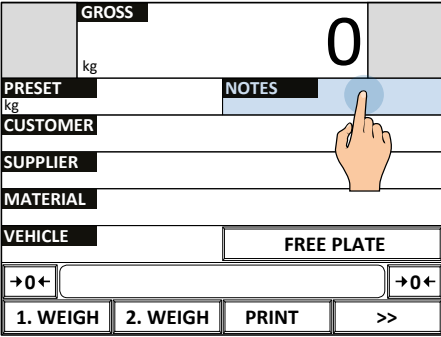
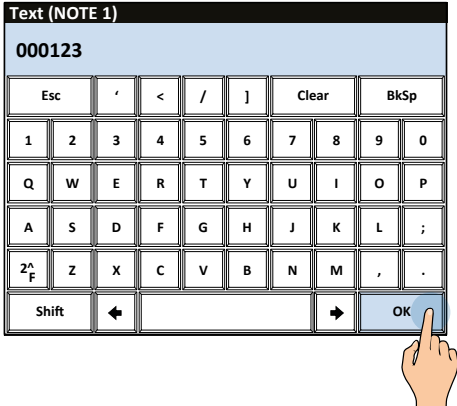
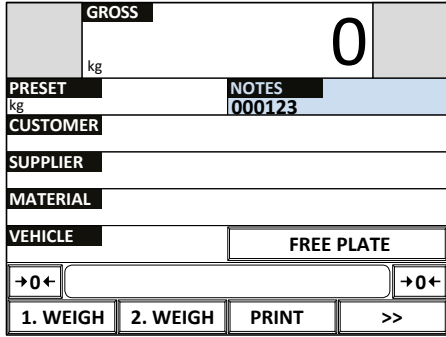
- 
- 
- 

How to access the complete list of texts

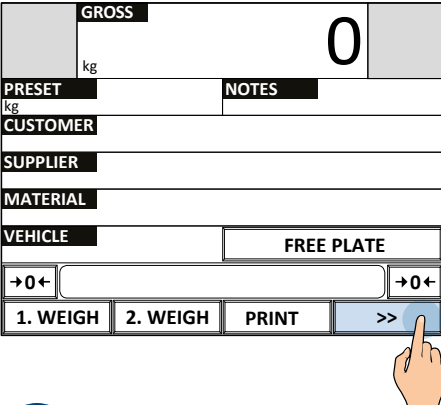
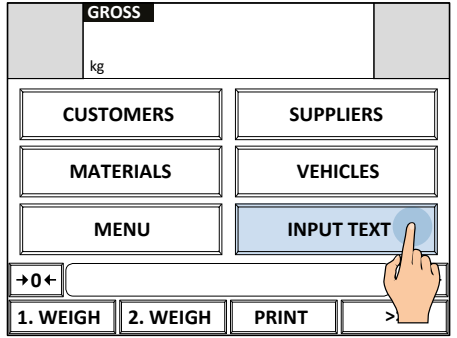
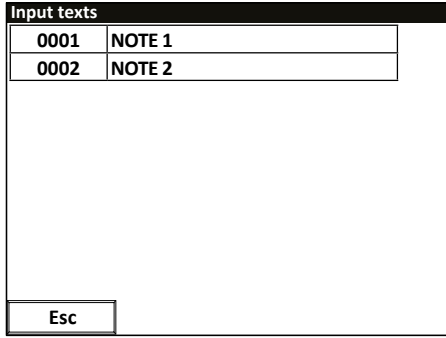
- 
- 
- 

i Additional text activation (up to 15) requires advanced configuration.

Alternatives:

1. Create buttons to directly fill out all the necessary identification texts, making filling out faster.

Example

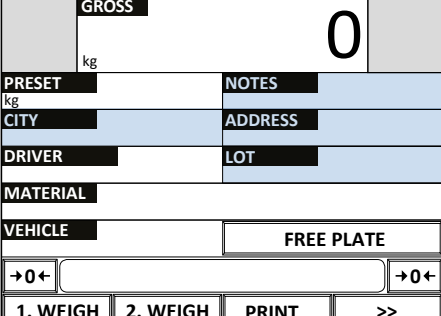



2. If the texts must be completed at each weighing, it is possible to create an automatic sequence for the operator's convenience (see page G-1).

1000 cards database

USE	Allows you to attach to a card one or more records of the database to speed up selection and automate weighing operations.
APPLICATIONS	Automated / Self service weighing
ACTIVATION	Filling out the cards and associating to the database are active as standard. Activation of automated weighing requires advanced configuration.

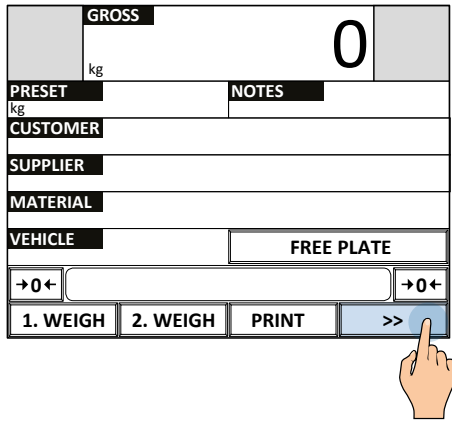
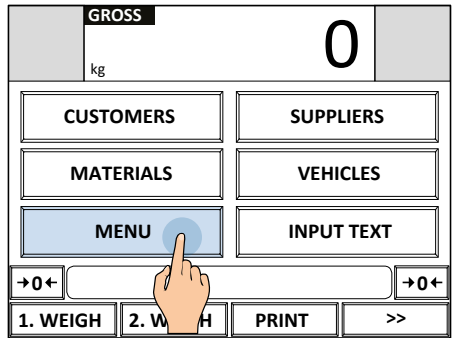
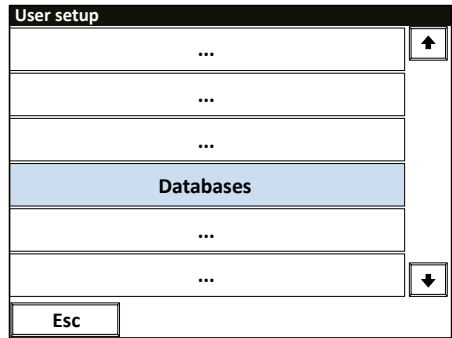
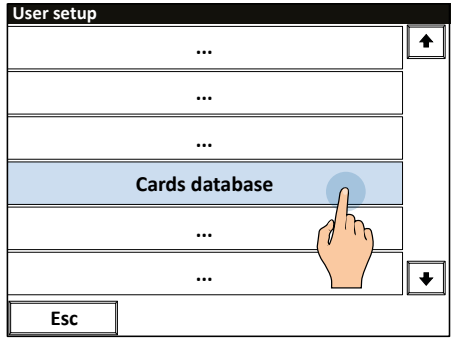
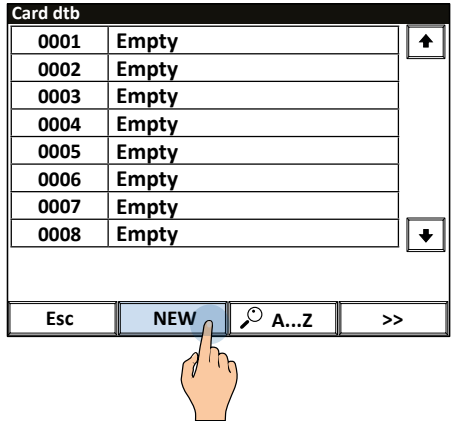
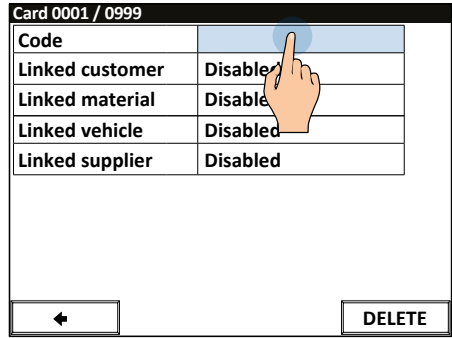
How to fill in the database

- 
- 
- 
- 
- 
- 
7. Identify the card by the reader.

8. Fill all the fields.

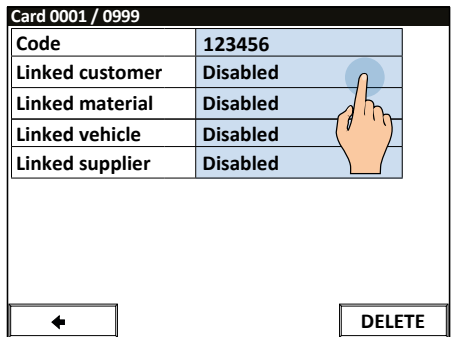
- It is possible to choose the selection mode for each linked record

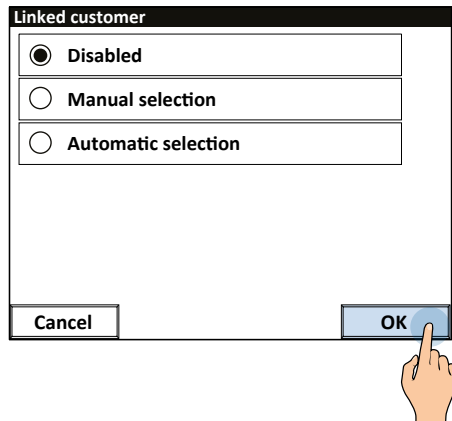

i By choosing "manual", the record selection will be asked to the driver during the weighing procedure (see page D-14)

Example of quick database records selection and manual execution of weighing.

1. Identification



2. Autofill

GROSS		50000	
kg			
PRESET		NOTES	
kg			
CUSTOMER	SMIDTH LTD		
SUPPLIER	WHITE LTD		
MATERIAL	CLAY		
VEHICLE		FREE PLATE	
XX 123 YY			
→0←			→0←
1. WEIGH	2. WEIGH	PRINT	>>

3.

GROSS		50000	
kg			
PRESET		NOTES	
kg			
CUSTOMER	SMIDTH LTD		
SUPPLIER	WHITE LTD		
MATERIAL	CLAY		
VEHICLE		FREE PLATE	
XX 123 YY			
→0←			→0←
1. WEIGH	2. WEIGH	PRINT	>>



Using the card you can also automatically execute the first and second weighing further speeding up the procedure. Enabling this feature requires advanced configuration.

Password to access the database management menu

USE	Allows you to protect database entry and editing (customers, suppliers, materials and trucks)
ACTIVATION	Activation requires advanced configuration.

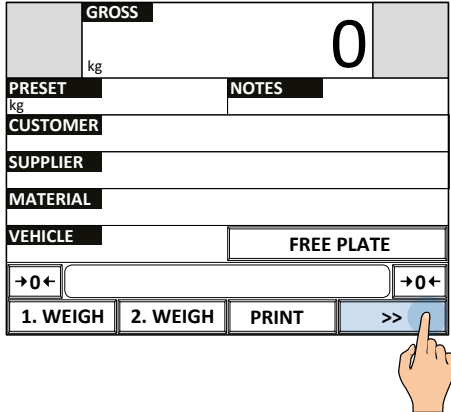
1. 

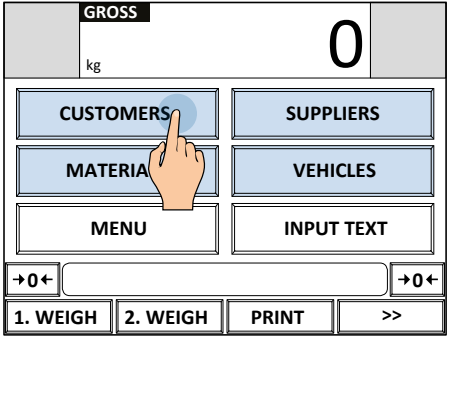
2. 

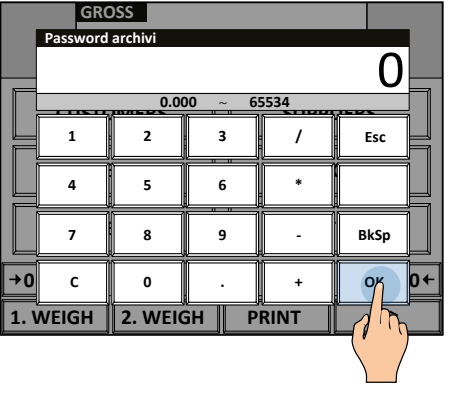
3. Enter the password and press OK 

i The password is univocal for database data entries.

Compiling database from PC with “DBManager”

USE	Allows you to quickly fill out the scale database from PC, with the possibility of importing data from excel files or directly from management program.
APPLICATIONS	Quick scale database update.
ACTIVATION	Activation requires advanced configuration.

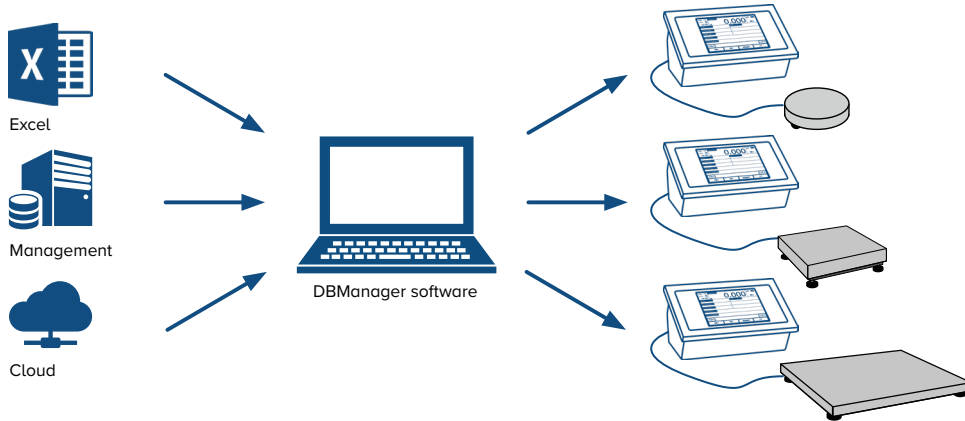

Introduction

The AF03 program includes the self service operating mode which allows the driver to perform weighings independently. Depending on the system to be set up, it is possible to select two different operating modes:

- Self-service weighing with identification by badge, RFID or remote control;
- Self service weighing charged with tokens or discount card.

For the badge, RFID or remote control identification mode, you can also choose the work mode:

- Single weighing
- Multiple weighing

DINI ARGEO offers a self-service system complete with touch screen indicator, identification device and printer.

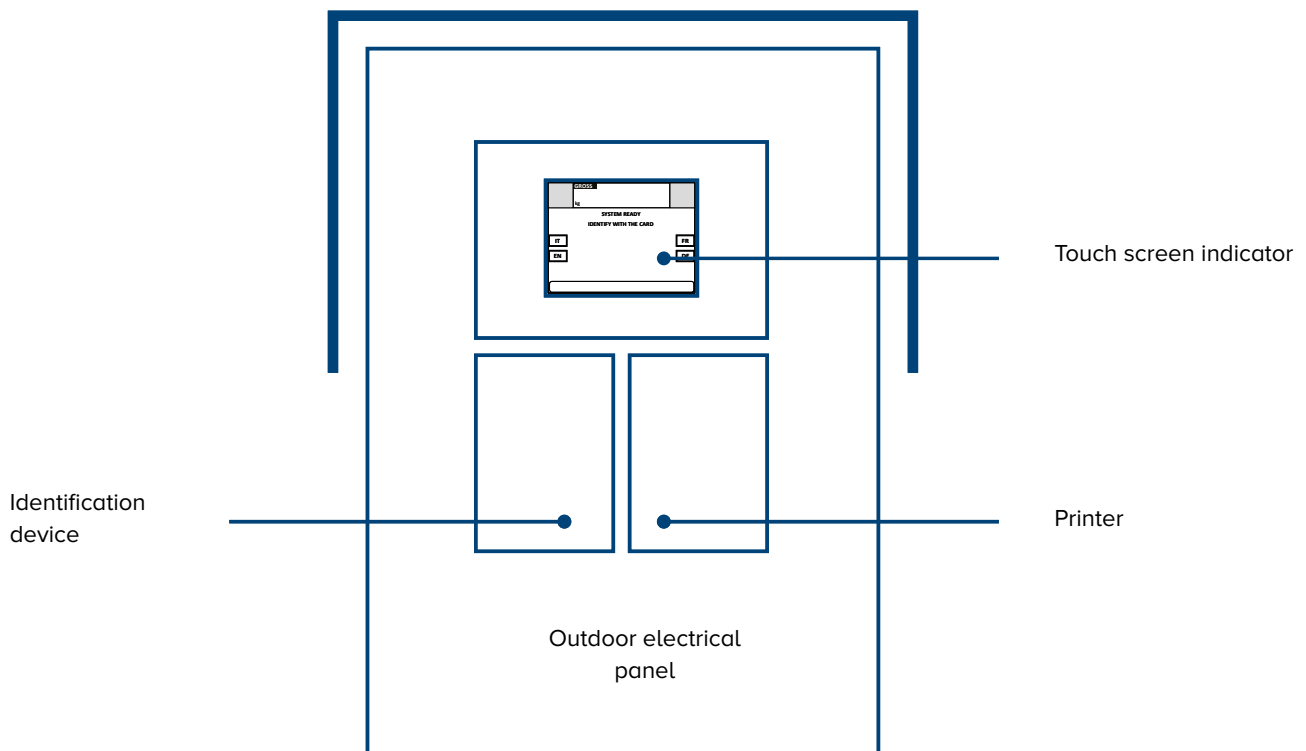

Display - main self service function screens

Automatic self service function

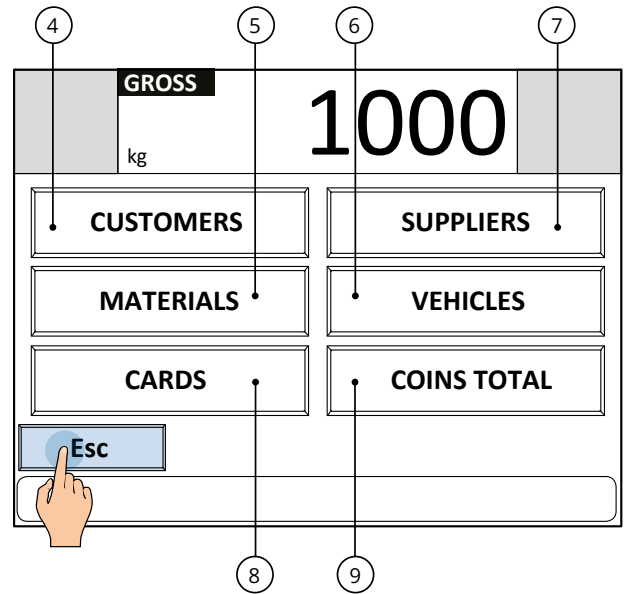
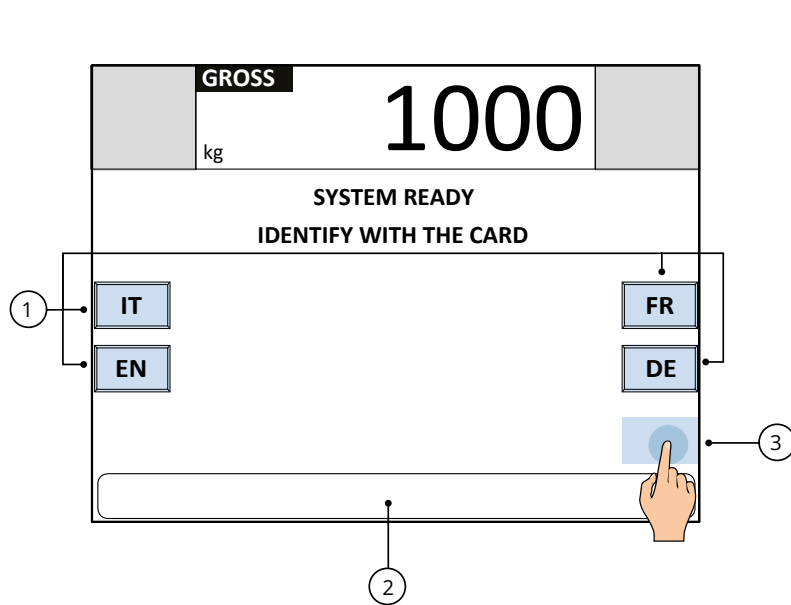

Button	Function
(1)	Language selection
(2)	Messages for the driver
(3)	Hidden button for access to the programming area
(4)	Customer database





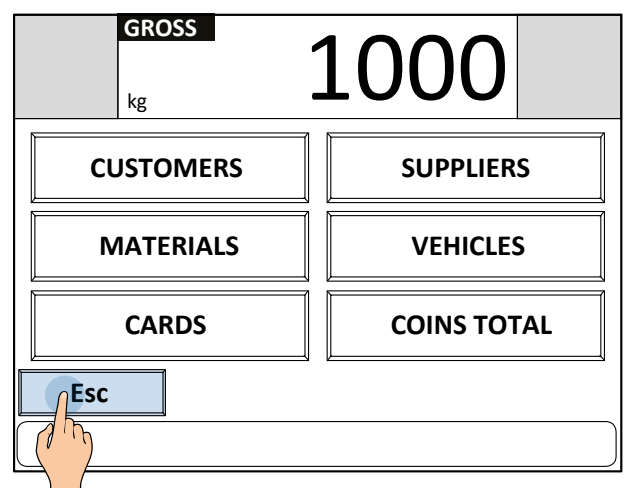
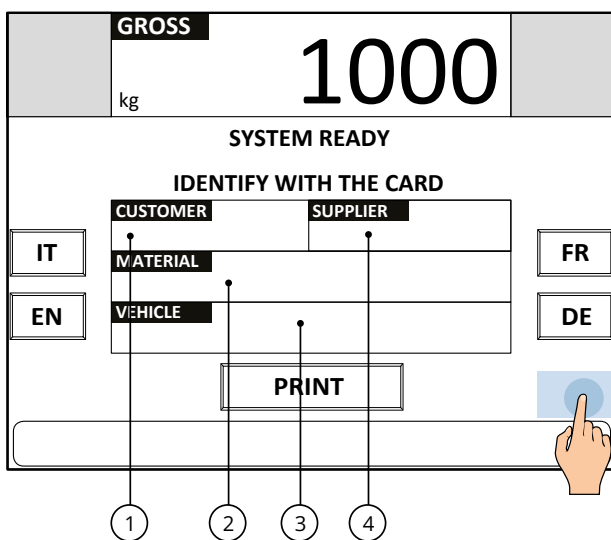

Button	Function
(5)	Materials database
(6)	Vehicles database
(7)	Suppliers database
(8)	Card programming
(9)	Total collection (for coin meter)

Self service functionality with manual selection of database



Button	Function
(1)	Customer database
(2)	Materials database
(3)	Vehicles database
(4)	Supplier database

Display symbols

Symbol	Description
→0←	The scale is unloaded and at zero (gross).
PT	You have selected a vehicle associated with tare weight.
~	The weight is unstable.
  	Printing in progress / printer anomalies.
W1 W2 W3	Indicate the range of active weighing.
 	Powered / Battery level
 A	Active scale.

Operation with badge / RFID

USE	Allow automatic selection of the associated database records and executing the weighing.
ACTIVATION	In self service mode the cards archive is automatically activated, on which the database record (truck numberplate, material, customer, etc.) are associated to each card.

Example of single weighing

1.

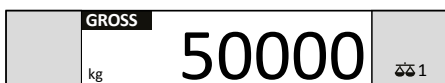

2. Select the language

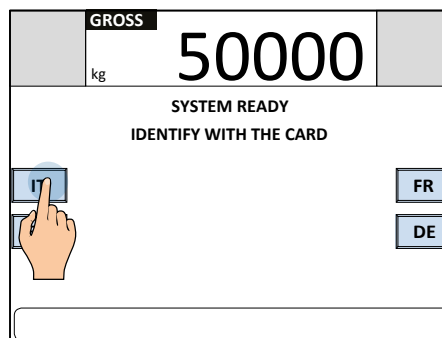

3. Identify

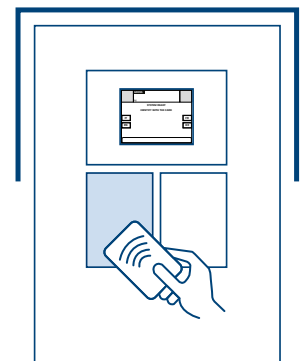

4.

DINI ARCEO Scales - Weighing systems	
PLATE	XY 123 XY
CUSTOMER	SMIDTH LTD
SUPPLIER	WHITE LTD
MATERIAL	ARGILLA
VEHICLE	XY 123 XY
SCALE	A
05/04/2016 16:00	
PROGRESSIVE	1
NET	50000 kg

i

- The weight can be always visible or inhibited until successful identification.
- The weighing operation is performed only if the card has been associated with a vehicle in the database.
- You may decide to select quickly the database records and allow the driver to identify manually by entering the numberplate of their vehicle.
- You can automatically select a part of the database records (e.g. customer and vehicle) and allow the driver to manually complete selection of the fields (e.g. material, supplier).

Example of multiple weighing

1.



2. Select the language

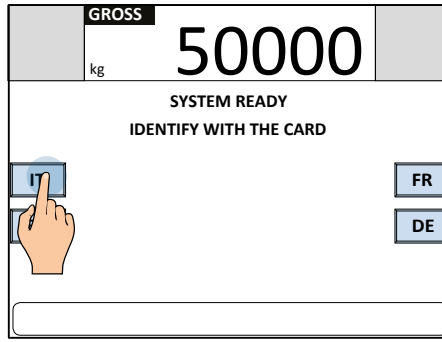

3. Identify

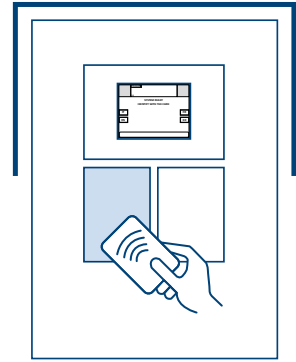

4.

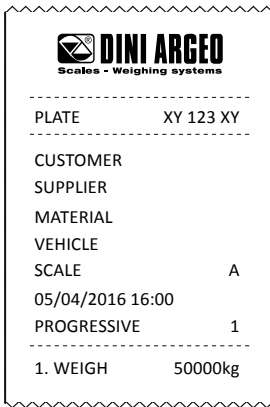

5.

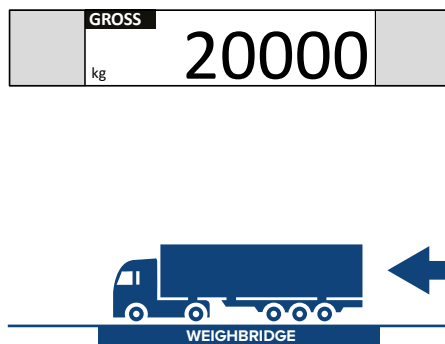

6. Select the language

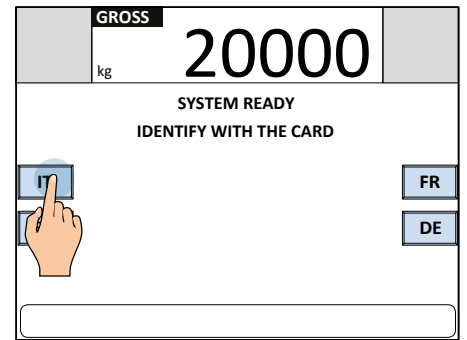

7. Identify

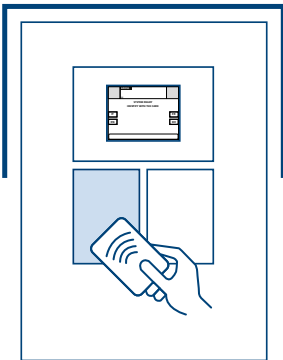

8.

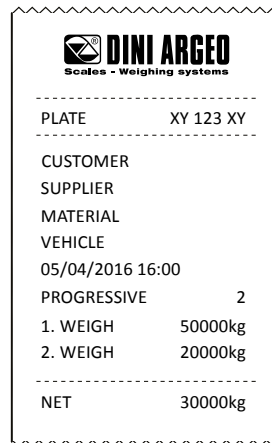

The weight can be always visible or inhibited until successful identification.

Multiple weighing with barcode reading

USE	Allows you to quickly retrieve the first weighing by reading the bar code printed on the receipt.
ACTIVATION	Activation requires advanced configuration.

Registration procedure of the first weighing

1. 

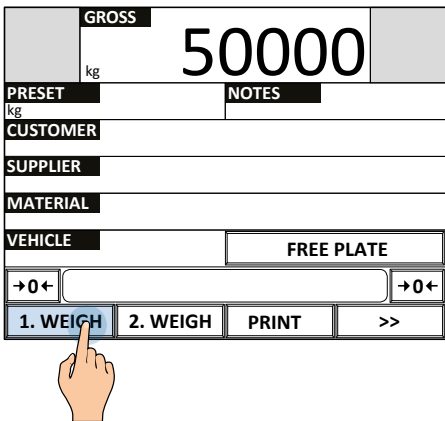
2. 

3. Enter the license plate of the vehicle

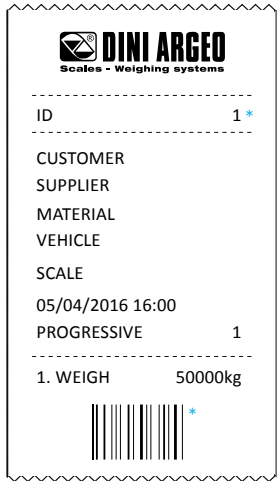

* The ID is also printed in the form of barcode

Registration procedure of the second weighing

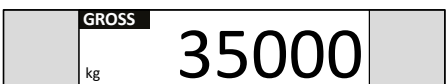
1. 

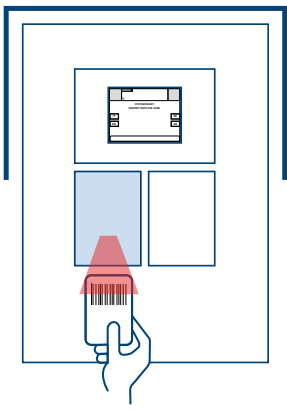
2. 

3. The second weighing is performed automatically, with summary receipt printing.

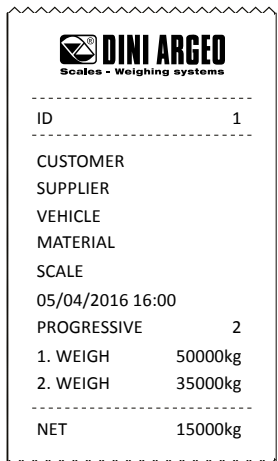

4. Now it is possible to print one or more copies of the receipt, or unload the weighbridge / press ESC to return to weighing mode.

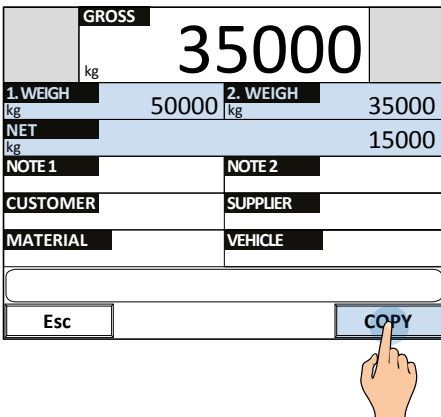

Operation with RF remote control

USE	Allows you to execute identification remotely through the use of an RF remote control. Useful in systems with access barriers.
ACTIVATION	Activation requires advanced configuration.

Application example

1. Press the identification key on the remote control

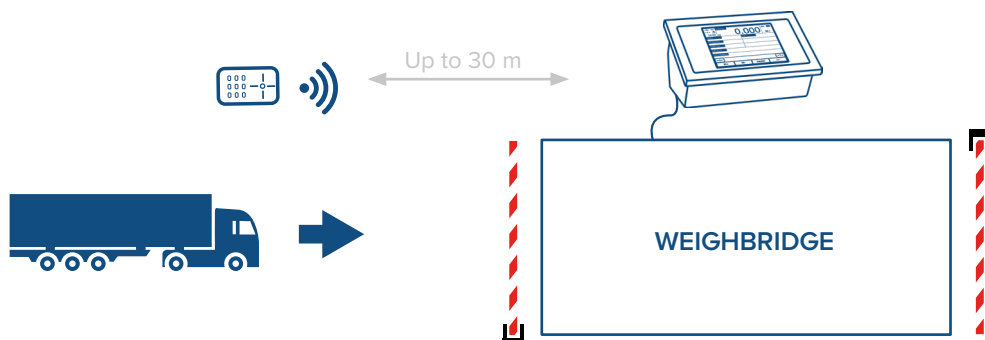

2. Access to weighbridge authorised and automatic weighing with stable weight.

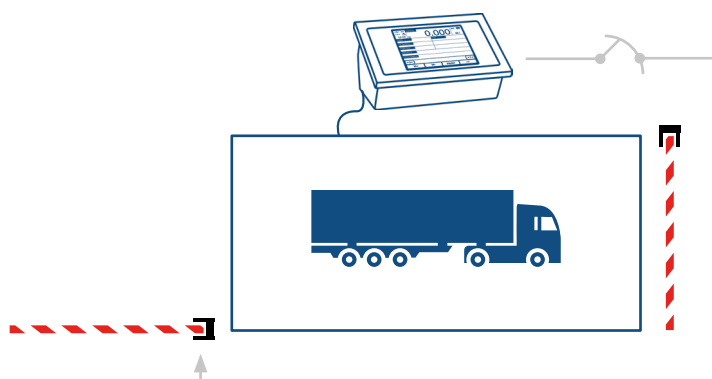

3. Successfully executed weighing

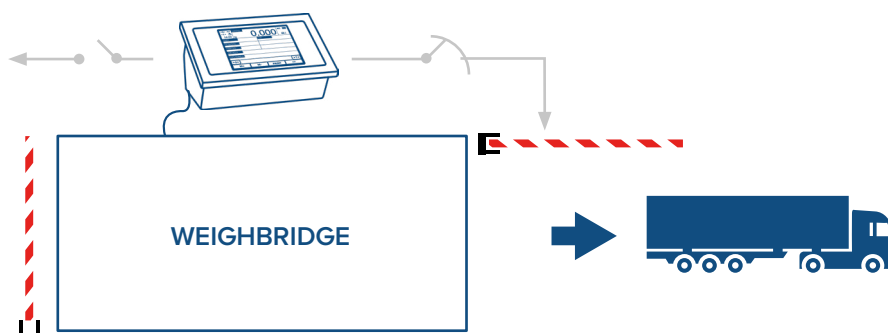

Remote control configuration (up to 1000)

USE	Allows you to associate to a remote control the customer, the material, the vehicle and the supplier for quick recognition.
ACTIVATION	Filling in of the database is active as standard. Enabling operation via the remote control requires an advanced setup.

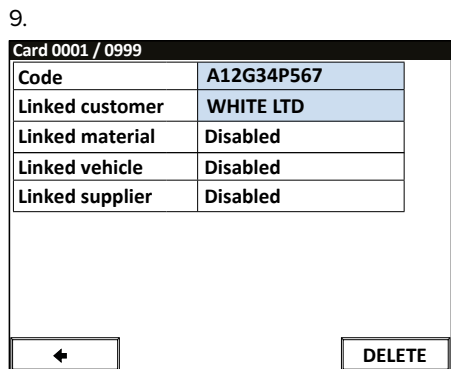
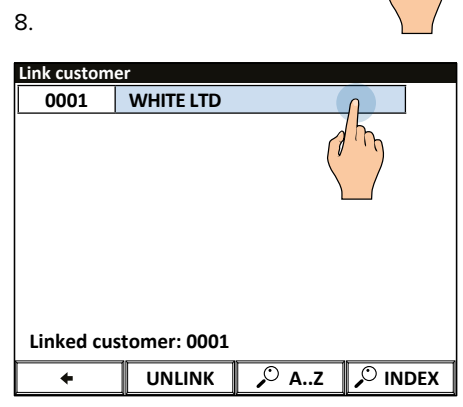
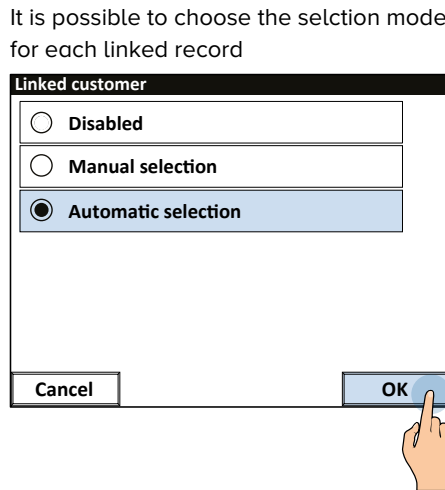
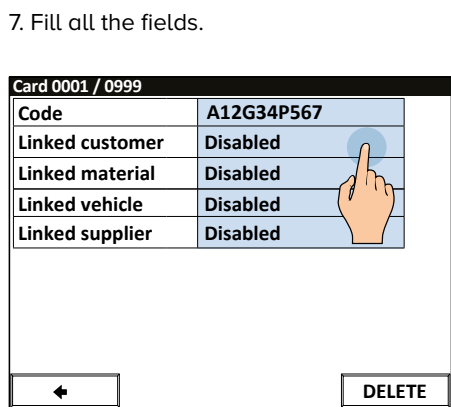
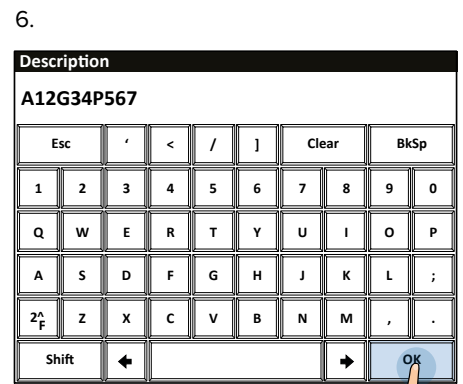
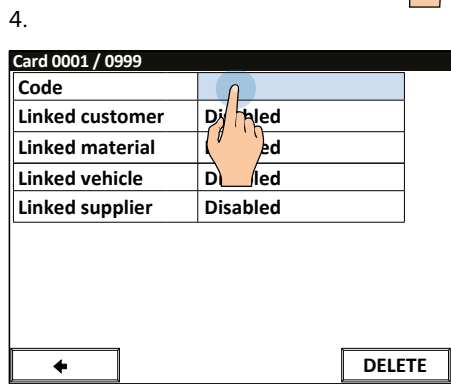
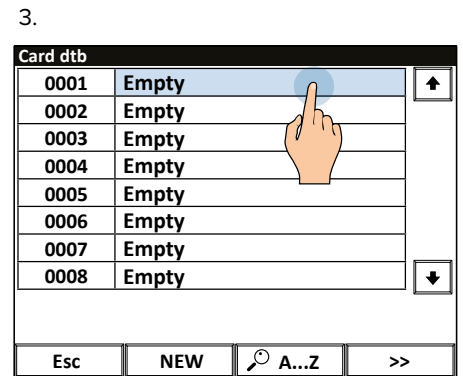
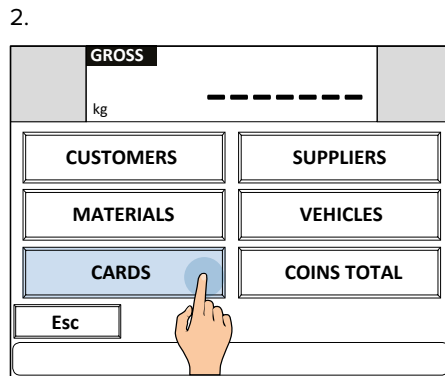
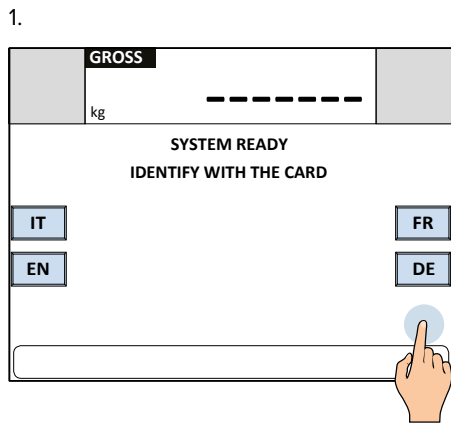

i Weighing is carried out only if a vehicle is associated to the remote control.

i By choosing "manual", the record selection will be asked to the driver during the weighing procedure (see page D-14)

Card configuration (up to 1000)

USE	Allows you to associate to a card the customer, the material, the vehicle and the supplier for quick recognition.
ACTIVATION	Filling in of the database is active as standard. Enabling operation by card requires an advanced setup.

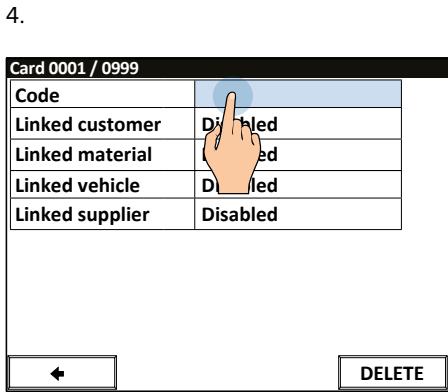
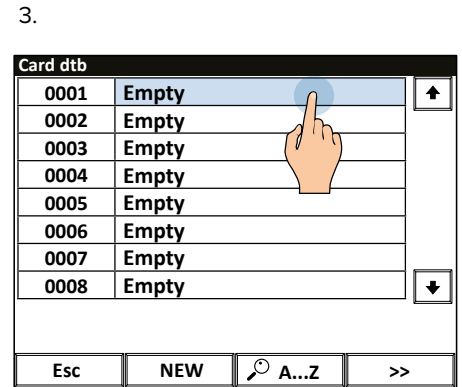
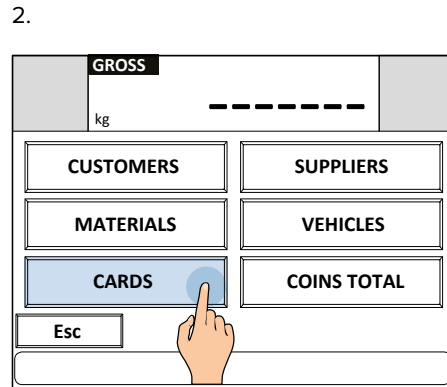
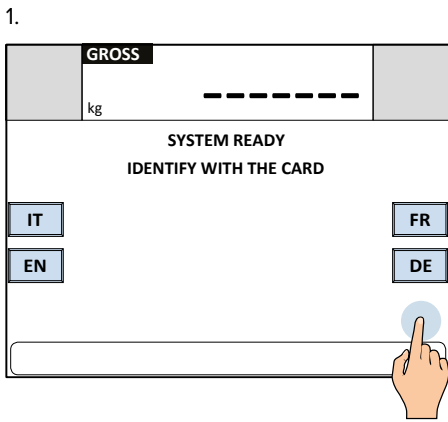

5. Identify the card by the reader.

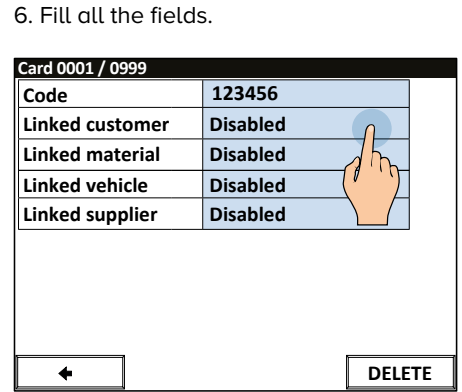

It is possible to choose the selection mode for each linked record

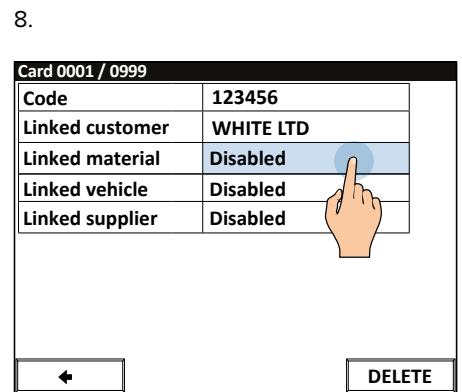
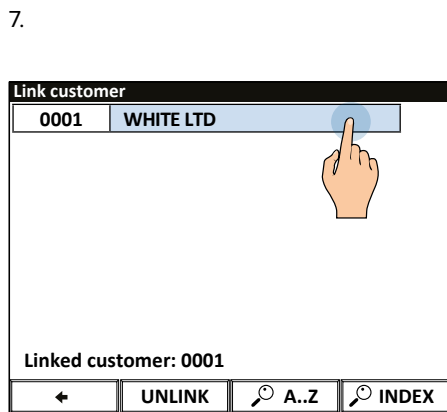
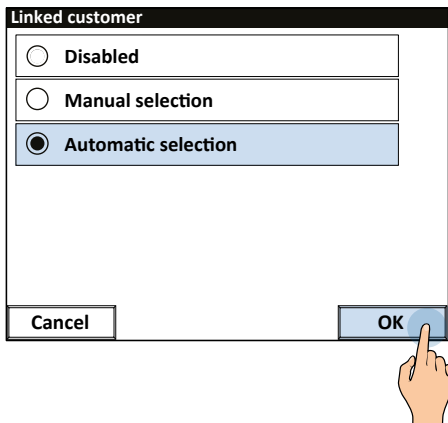

i Weighing is carried out only if a vehicle is associated to the card.

i By choosing "manual", the record selection will be asked to the driver during the weighing procedure (see page D-14)

Weighing charge with coin acceptor

USE	Allows you to perform weighings only upon payment of the set amount. The weighing fee is determined based on the weight, with the option to configure up to six different thresholds.
ACTIVATION	Weighing charge activation and setup of payment thresholds require advanced configuration

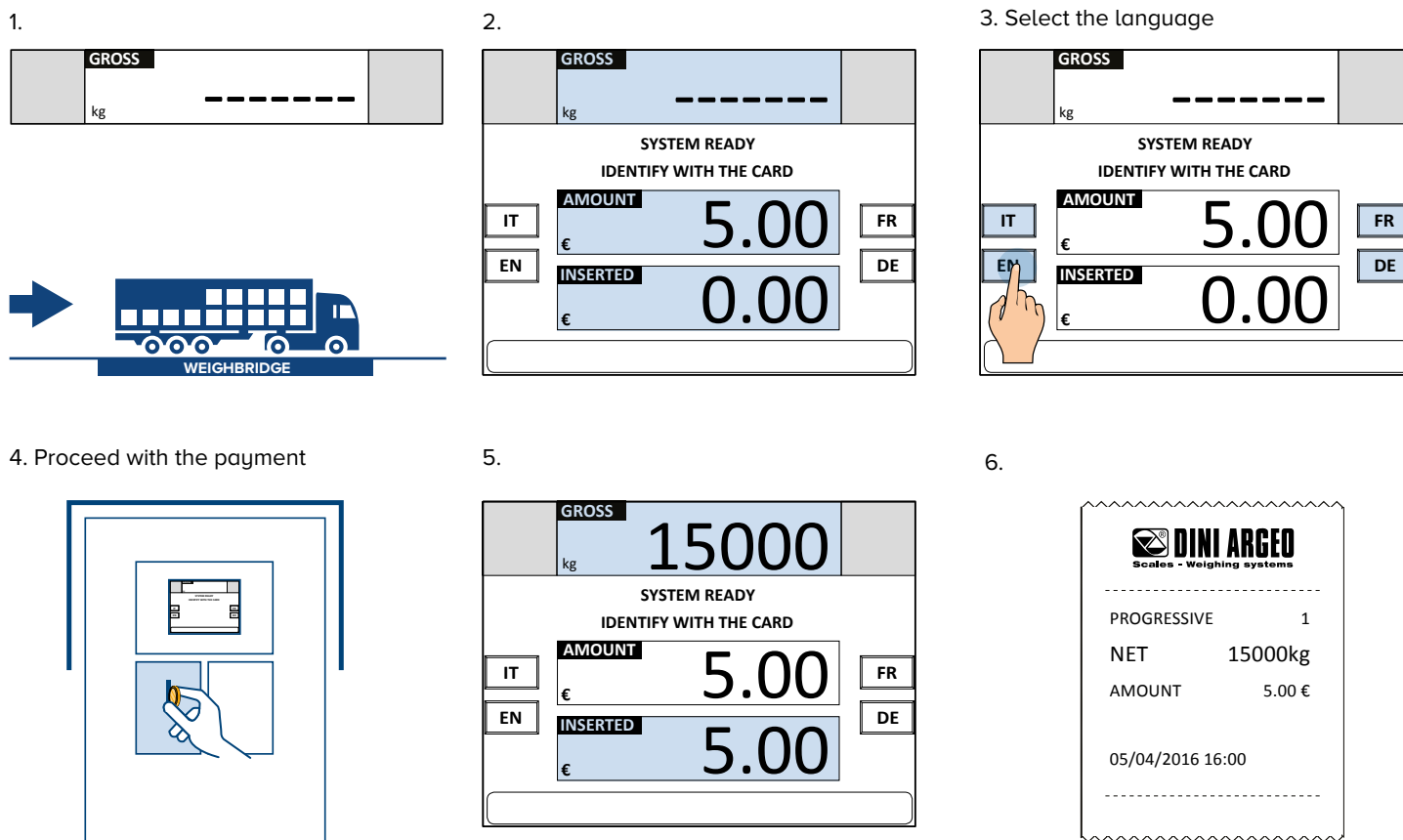

i

- The weight may always be visible or inhibited until successful payment.
- The system can operate either with tokens or with coins.
- Decimals and currency are freely configurable.

i

The weighing fee is freely configurable and is based on one or more weight thresholds (up to 6).
 Example:
 up to 2,000 kg = € 2.00;
 from 2,001 to 10,000 kg = € 4.00;
 from 10,001 to 20,000 kg = € 5.00;
 etc.

How to know and clear the total coins

1.

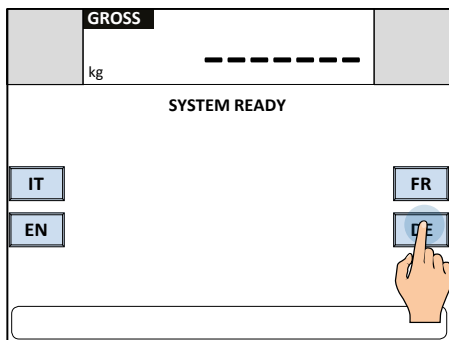

2.

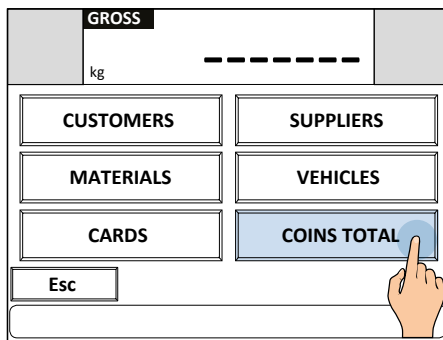

3.



4.

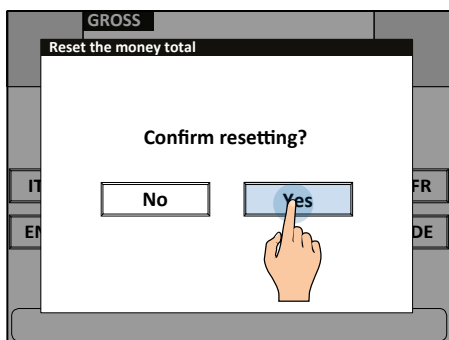

Instant debit / postponed payment weighing or free weighing

USE	Allows you to manage payment of the weighing through card, without using cash. This functionality needs the selection of a customer from database.
ACTIVATION	Activation requires advanced configuration.

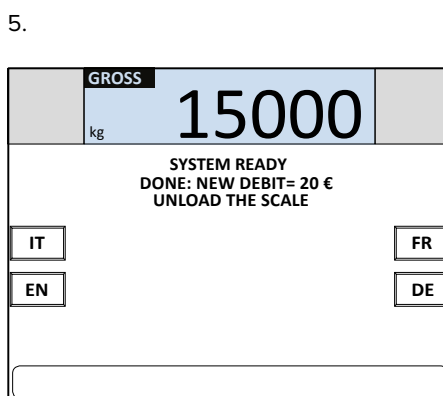
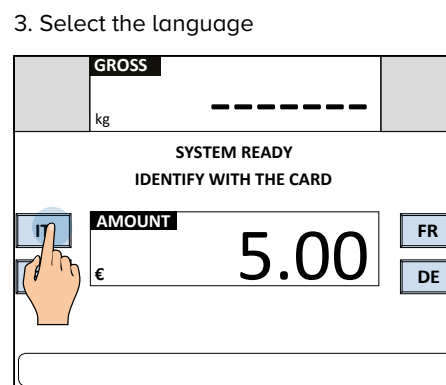
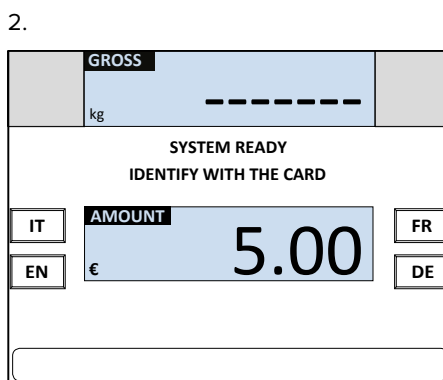
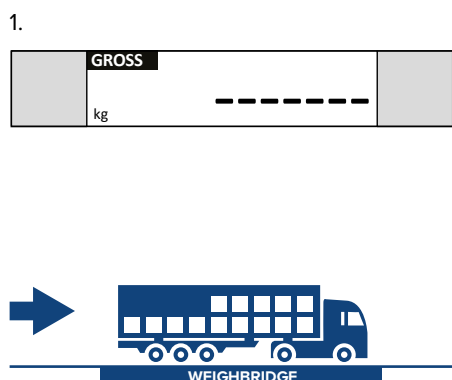

i

- The weight may always be visible or inhibited until successful payment.
- Decimals and currency are freely configurable.

How to assign the payment system for each customer

ACTIVATION The payment system associated with the customer is selected when filling in the customers database.

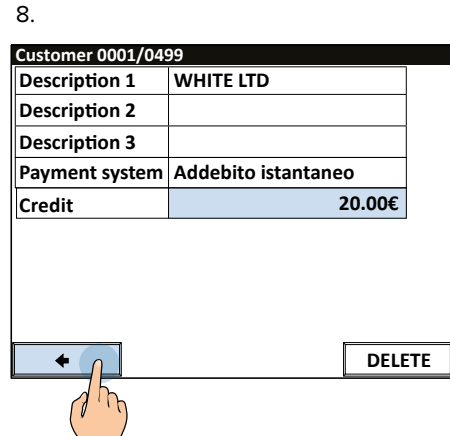
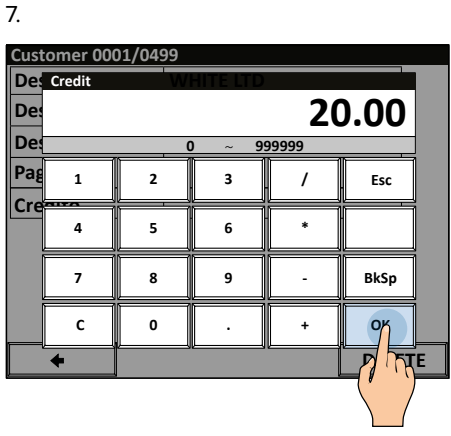
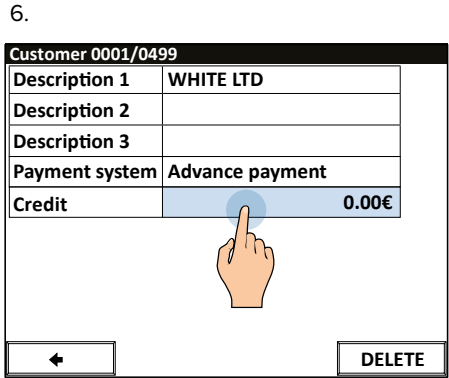
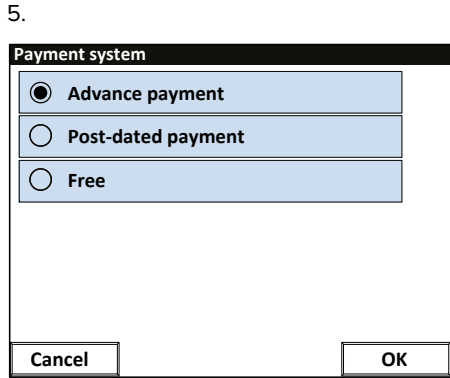
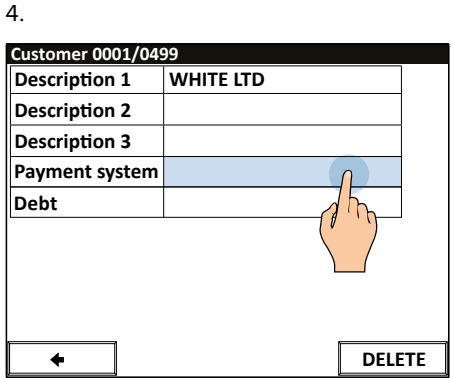
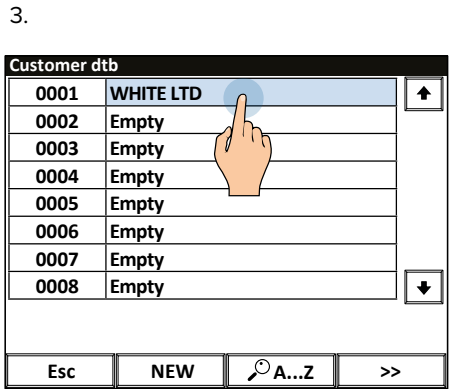
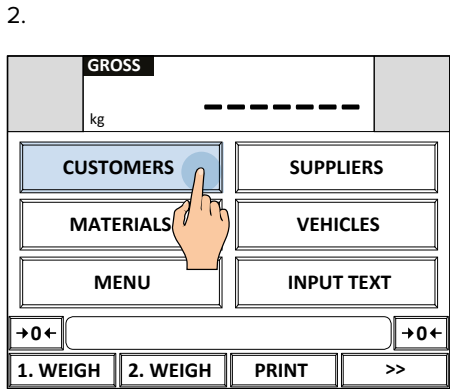
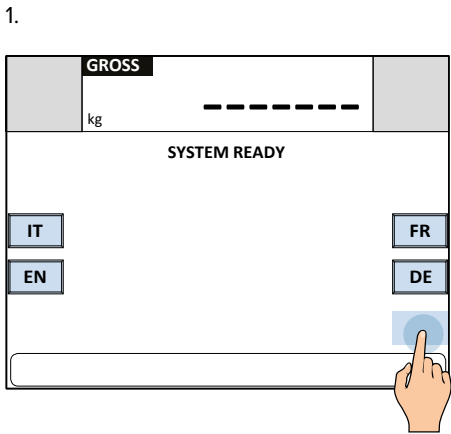

How to know the debt accumulated by a customer

ACTIVATION Viewing the accumulated debt is only available if the deferred payment mode is active.

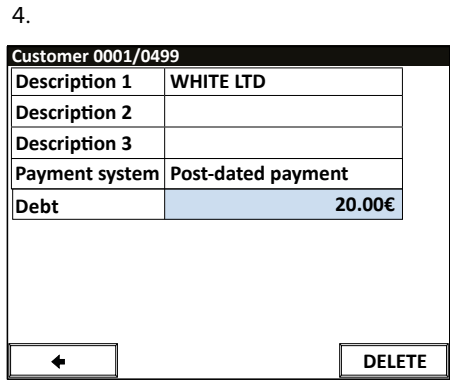
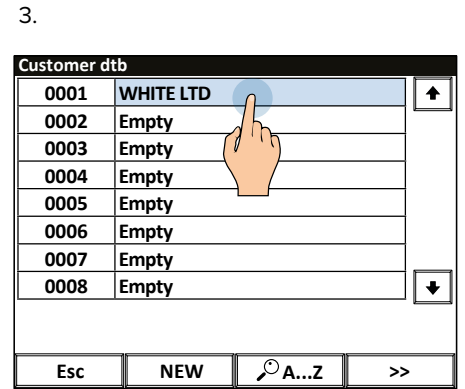
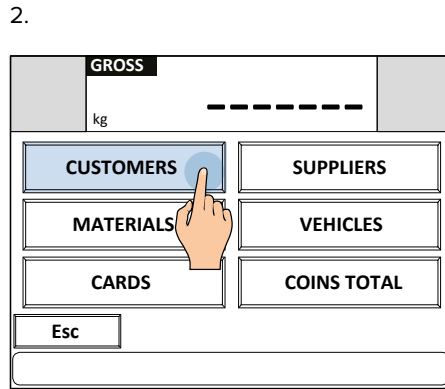
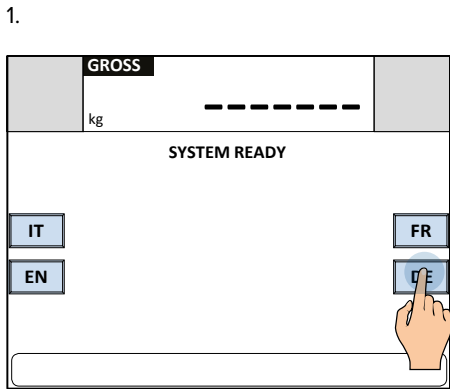

How to know and clear the total paid by a customer

ACTIVATION This function is activated as standard in the self service for a fee mode.

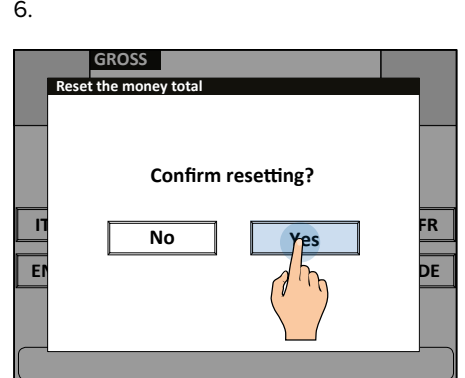
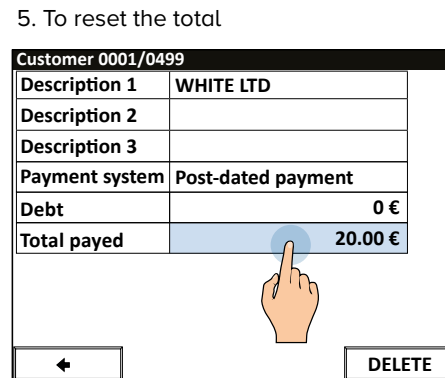
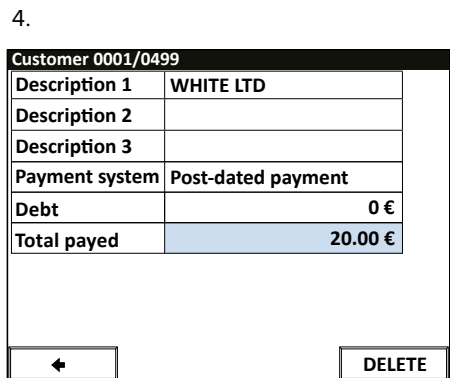
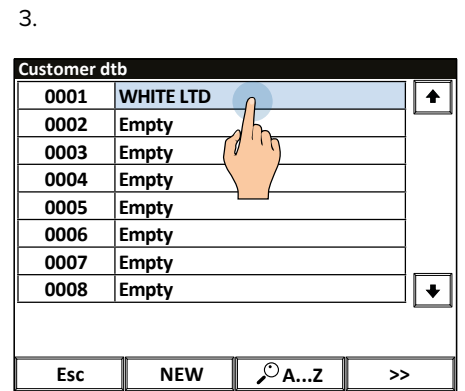
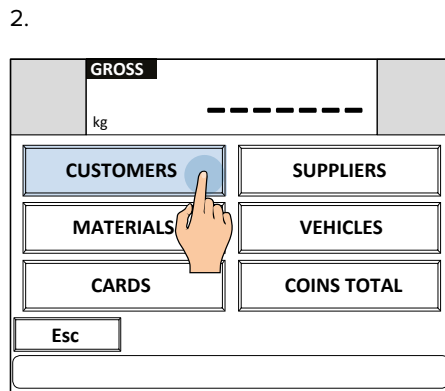
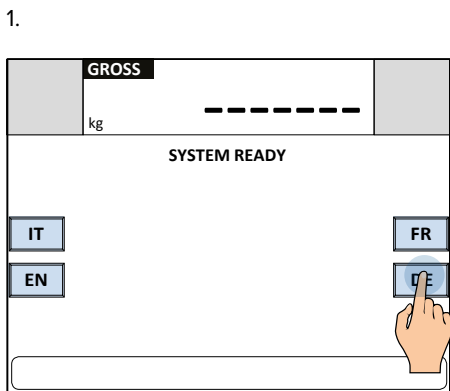

How to request a driver to enter some data

USE	Allows you to automatically select the fixed data (customer, vehicle) and request the driver to enter the variable data, such as the transported material and the supplier.
ACTIVATION	In the self service mode with badge/RFID recognition the function is active as standard.

1.

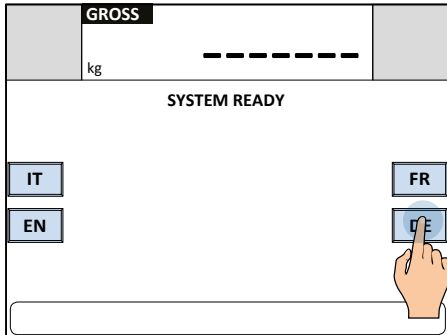

2.

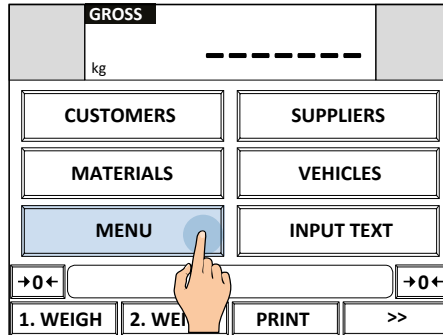

3.

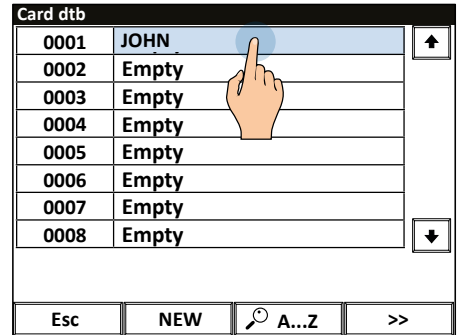

4.

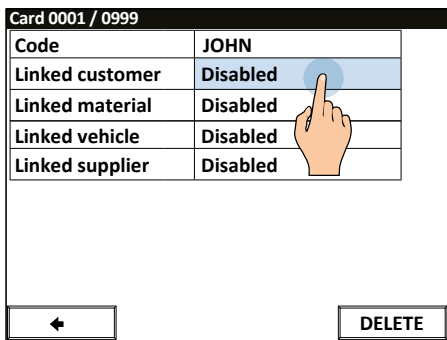

5.

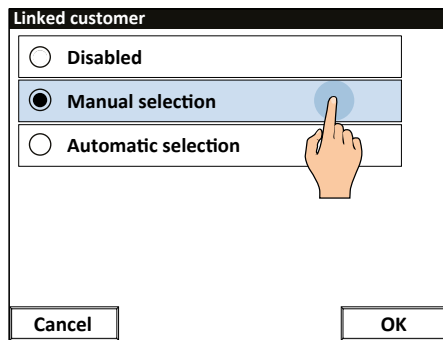

i Upon weighing the driver will have to manually enter all data configured as “manual selection”. The data will be required in sequence.

Data Printing / Communication / Transmission

The indicator has 3 serial ports to communicate with one or more printers / labellers, PCs and weight repeaters. Alternatively, it is possible to expand communication with the company IT system, tablet and Smartphone, cloud or PLC by adding the available optional interfaces:

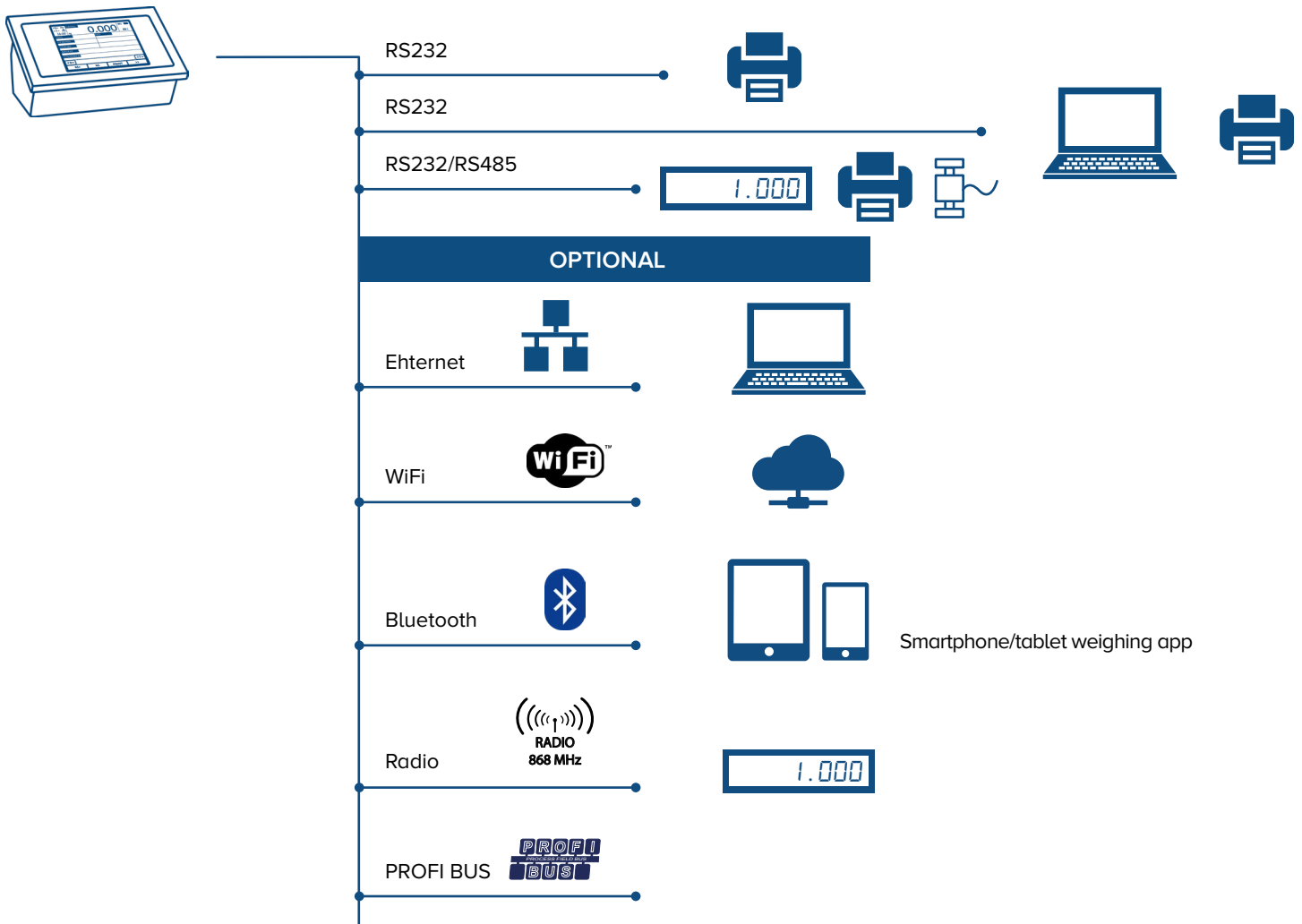

The communication protocol can be fully customised to easily integrate the weight indicator into existing systems that use other brand scales without having to change the programs being used.

Simple print

USE	Allows you to print the instant weight on the scale.
APPLICATION	Internal controls / Traceability.
ACTIVATION	Standard active function.

1.



2.

GROSS		20000	
kg			
PRESET		NOTES	
kg			
CUSTOMER			
SUPPLIER			
MATERIAL			
VEHICLE		FREE PLATE	
→0←			→0←
1. WEIGH	2. WEIGH	PRINT	>>

3.

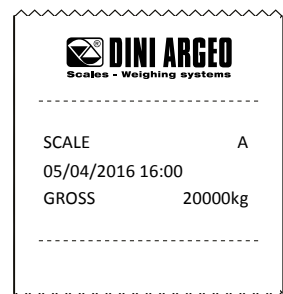

Customisable print format

USE	Allows you to issue printouts, in single or multi copy, at each weighing.
ACTIVATION	Activation requires advanced configuration.

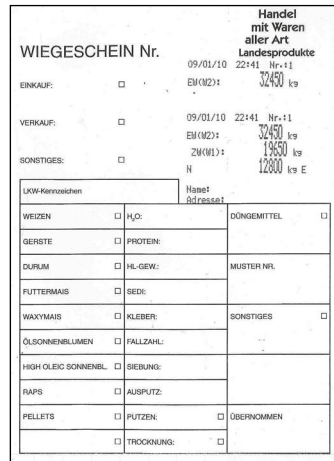
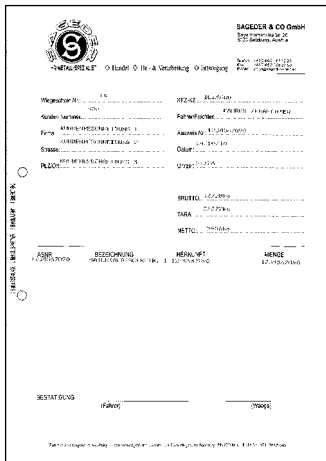

Over 300 data available to print

- Weights
- Descriptions
- Texts
- Traceability Data
- Images
- Logos
- Barcode/QR Codes
- Dates (production, packaging, deadline etc)
- Batch
- Operator

Multi-copy printing

USE	Allows you to issue up to 5 copies of the same receipt.
ACTIVATION	Standard active function.

1.

2.

3.

4. 5. Enter the number of copies and press OK to confirm

6.



7.

GROSS		20000	
kg			
PRESET	NOTES		
CUSTOMER			
SUPPLIER			
MATERIAL			
VEHICLE	FREE PLATE		
->0<			->0<
1. WEIGH	2. WEIGH	PRINT	>>



8. Automatic multi-copy printing at every weigh

Copy 1

	
ID	1
CUSTOMER	
SUPPLIER	
MATERIAL	
VEHICLE	
SCALE	A
05/04/2016 16:00	
PROGRESSIVE	1
1.WEIGH	20000kg

Copy 2

	
ID	1
CUSTOMER	
SUPPLIER	
MATERIAL	
VEHICLE	
SCALE	A
05/04/2016 16:00	
PROGRESSIVE	1
1.WEIGH	20000kg

Copy 3

	
ID	1
CUSTOMER	
SUPPLIER	
MATERIAL	
VEHICLE	
SCALE	A
05/04/2016 16:00	
PROGRESSIVE	1
1.WEIGH	20000kg

Repeat last printout

USE	Allows you to repeat printing of the last issued receipt.
ACTIVATION	Standard active function.

-
-
-
-
-

Alternative

After performing the second weighing it is possible to reprint multiple copies of the receipt by pressing the COPY button.

-
-
-

Real time saving on USB mobile media

USE	Allows you to have a backup of more than 5.000.000 weighs and correlated data.
APPLICATIONS	<ul style="list-style-type: none"> • Traceability of weighings • Control reporting • Empowering operators
ACTIVATION	Activation requires advanced configuration.

i Note: while weighing, the USB drive must be installed

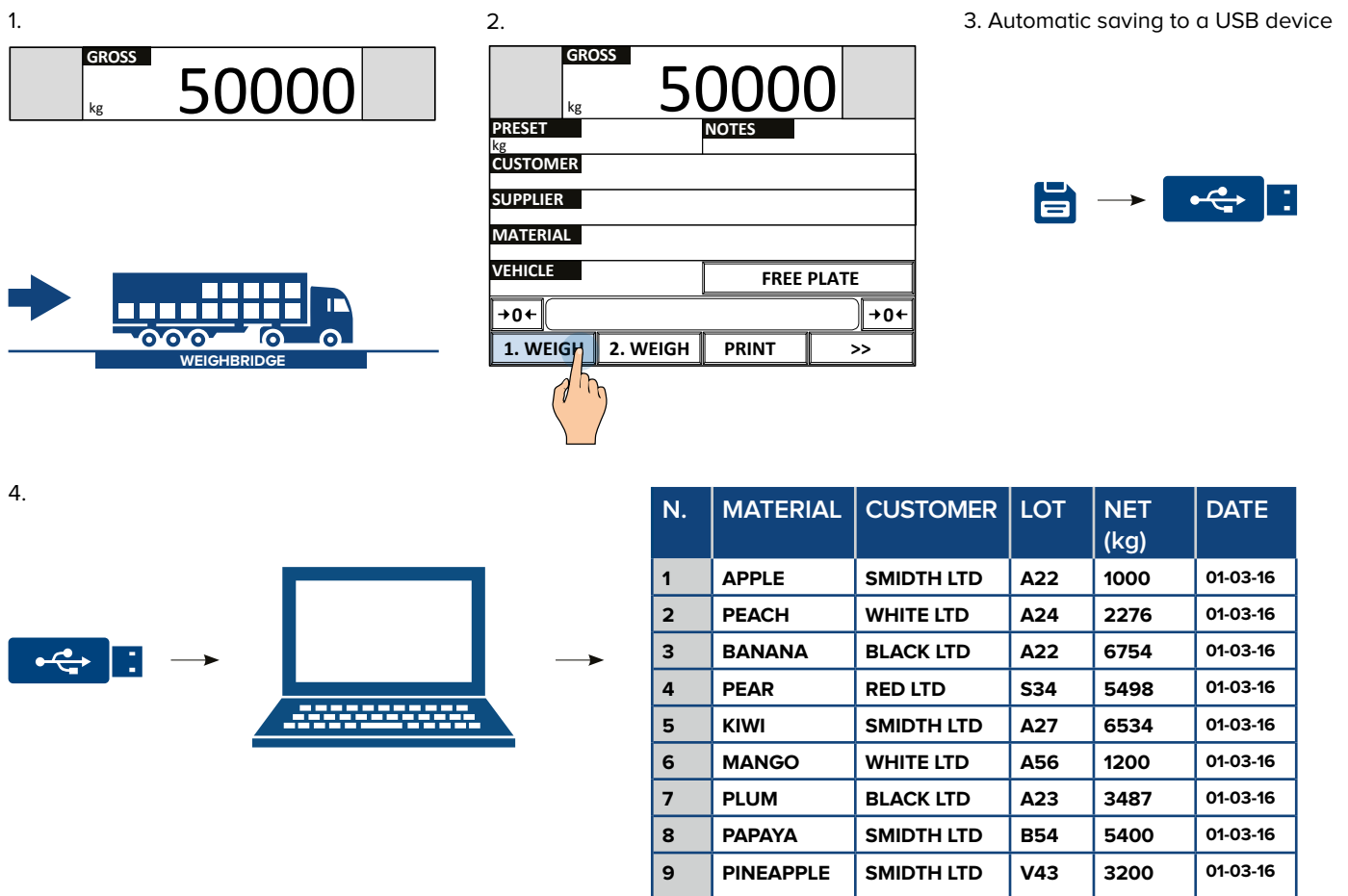

i The data saved for each weigh are fully customisable, with descriptions, texts, weights and many other data as necessary.

Saving on alibi memory

USE	The fiscal memory allows you to store the weighings performed (up to 130,000) and transfer them to the IT system for use in commercial transactions with third parties.
APPLICATIONS	Entering the weight in transport documents, invoices, reports for commercial transactions with third parties.
ACTIVATION	Activation requires advanced configuration.

Every performed weighing is recorded on the fiscal memory and identified by a unique numeric code, which must be noted along with the weight on the documents issued.

Example:

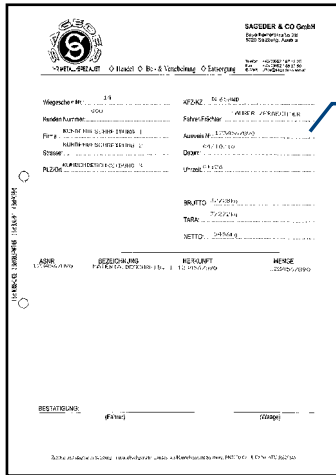

Weight
123.0kg (00000-000260)

This code allows you to trace and verify the weighing data on the indicator in the event of any disputes, proving the correctness of the indicated weight.

How to record a weighing

1.

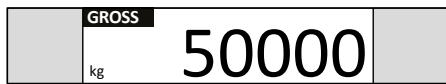

2.

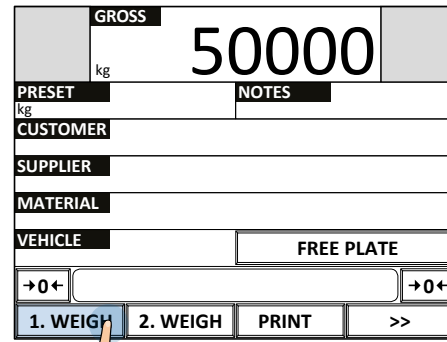

3. Automatic printing and storing at every totalisation.

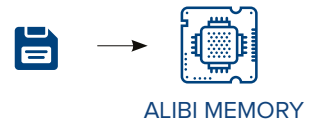

Read the alibi memory

USE	Allows you to check a weighing saved in the alibi memory.
APPLICATIONS	Quality control / traceability / verification
ACTIVATION	The fiscal memory (alibi memory) is integrated as standard in the main board of the indicator. Activation requires advanced configuration

Example:

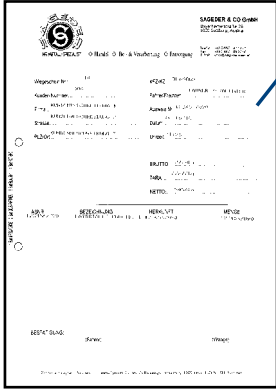

Alibi memory ID code to be verified:

123.0kg (0 - 260)

Rewriting
number

Weighing
number

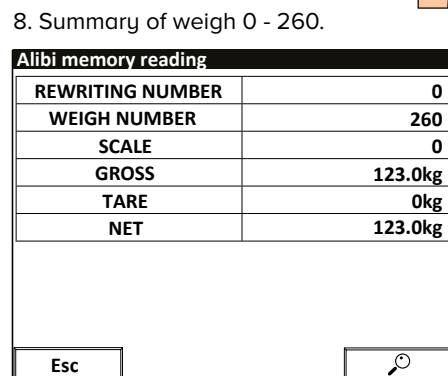
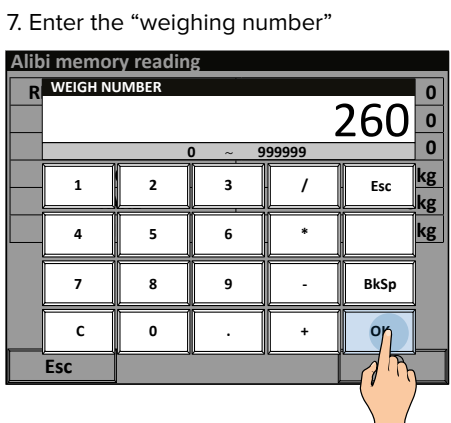
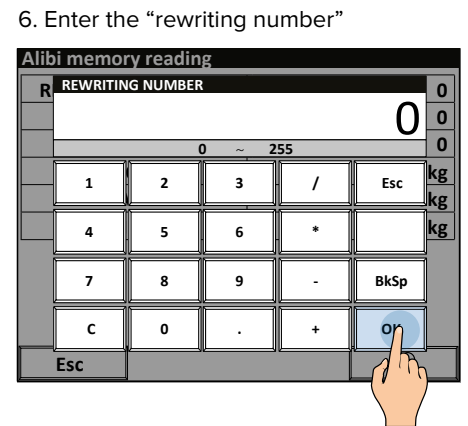
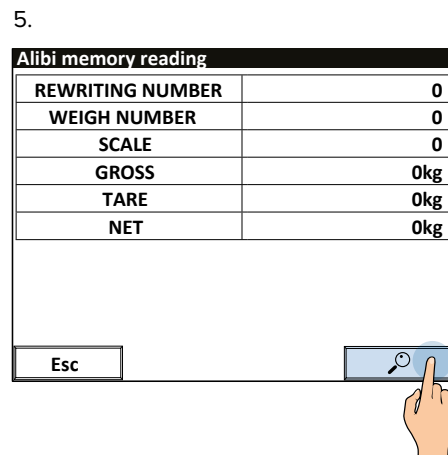
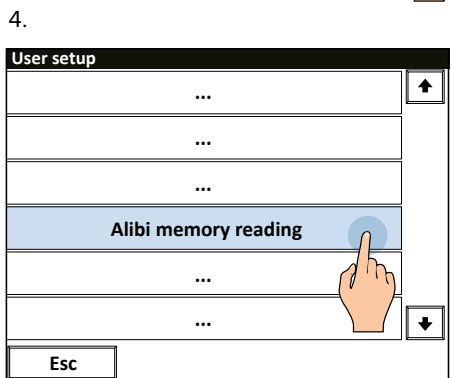
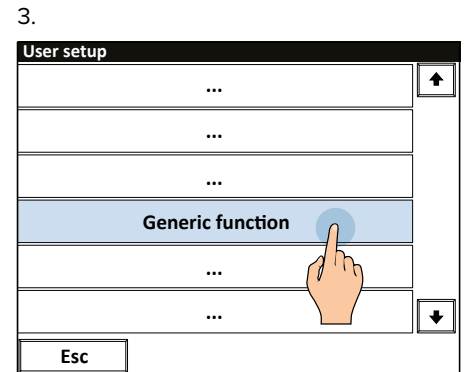
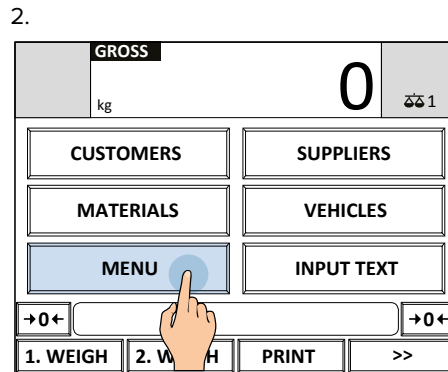
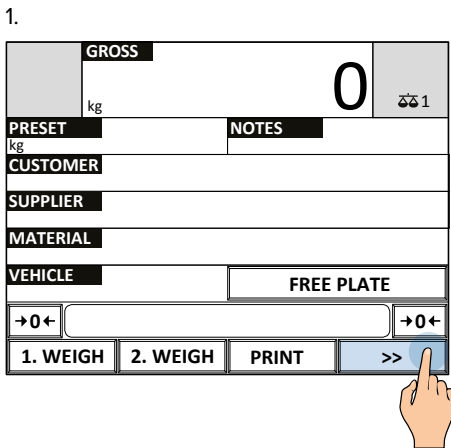

Saving weighings to PC via “WeiMonitor” program

USE	“WeiMonitor” is a computer program that allows you to receive and save each weigh in real time, with all the related traceability data (descriptions, batch, operator, date, etc.)
APPLICATIONS	Traceability / Production monitoring
ACTIVATION	The “WeiMonitor” program is optional, requires a license and advanced configuration.

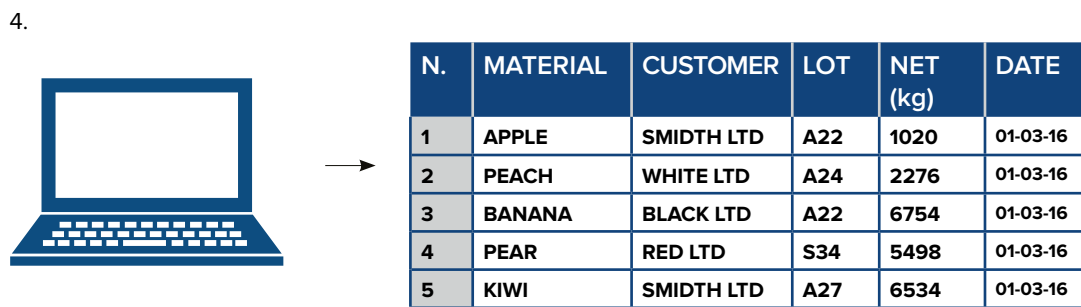
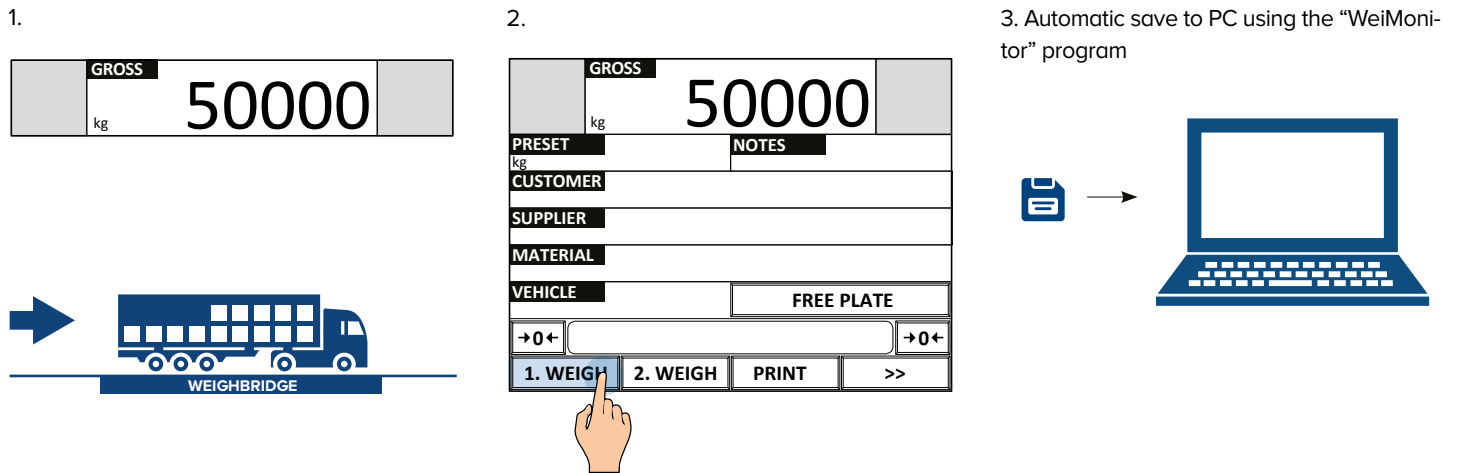

Communication between scale and PC occurs via RS232, USB, Ethernet or WiFi (see page E-1).

Notes on “WeiMonitor”:

- It installs easily and only requires a serial or Ethernet connection with the scale.
- It can record weights on multiple scales simultaneously.
- The stored data can be customised to suit your needs.
- Includes the keyboard emulation function to enter the weight directly in the open document.
- Can record weights for preset periods and plot graphs.

Customising the weight indicator

A strength of the product you have purchased is its ability to be customised to seamlessly integrate into the application for which it is intended. You can customise:

- The main work screen, making it easy and user-friendly, reducing the possibility of errors.
- Operational sequences, to guide employees in operations, speeding up processes.
- Operational messages, important to warn or remind of any peculiarities or errors during weighing operations.
- You can customise the application to integrate the scale into pre-existing weighing systems.
- Communication protocol, useful to interface the scale with pre-existing programs.

Operational sequences

USE	Allow you to create wizards to speed up the operator's work, reducing errors. You can create up to 10 different procedures, each made up of 10 consecutive operations. Each sequence can be combined with any key or text box on the main screen.
APPLICATIONS	Wizards for the operator.
ACTIVATION	Activation requires advanced configuration.

Example

sequence requiring automatically, before recording the first weighing, selecting the customer, material, filling in the free texts, acquisition of weighing and automatic issue of the printout:

-
-
- | Customer dtb | |
|--------------|-----------|
| 0001 | WHITE LTD |
| 0002 | Empty |
| 0003 | Empty |
| 0004 | Empty |
| 0005 | Empty |
| 0006 | Empty |
| 0007 | Empty |
| 0008 | Empty |
- | Material dtb | |
|--------------|--------|
| 0001 | KAOLIN |
| 0002 | CLAY |
| 0003 | SAND |
| 0004 | GRAVEL |
| 0005 | OTHER |
| 0006 | EMPTY |
| 0007 | EMPTY |
| 0008 | EMPTY |
- | Text (NOTE 1) | | | | | | | | | | | | |
|----------------|---|---|---|---|-------|------|---|---|----|--|--|--|
| JOHN | | | | | | | | | | | | |
| Esc | ' | < | / | J | Clear | BkSp | | | | | | |
| 1 | 2 | 3 | 4 | 5 | 6 | 7 | 8 | 9 | 0 | | | |
| Q | W | E | R | T | Y | U | I | O | P | | | |
| A | S | D | F | G | H | J | K | L | ; | | | |
| 2 ^F | Z | X | C | V | B | N | M | , | . | | | |
| Shift | ← | | | | | | | → | OK | | | |
-
- | DINI AR GEO | | Scales - Weighing systems | |
|------------------|-----------|---------------------------|--|
| ID: | 1 | | |
| CUSTOMER | WHITE LTD | | |
| MATERIAL | SAND | | |
| NOTE 1 | JOHN | | |
| NOTE 2 | 000123 | | |
| 05/04/2016 16:00 | | | |
| PROGRESSIVE | 1 | | |
| 1. WEIGH | 50000kg | | |

Operational messages

USE	Allow to communicate messages to the operator in the language of your choice at the desired time.
APPLICATIONS	Wizards for the operator.
ACTIVATION	Activation requires advanced configuration.

GROSS		0	
kg			
PRESET	NOTES		
kg			
CUSTOMER			
SUPPLIER			
MATERIAL			
VEHICLE		FREE PLATE	
→0←	APPLY LABEL		→0←
1. WEIGH	2. WEIGH	PRINT	>>

GROSS		0	
kg			
PRESET	NOTES		
kg			
CUSTOMER			
SUPPLIER			
MATERIAL			
VEHICLE		FREE PLATE	
→0←	CLOSE THE BOX		→0←
1. WEIGH	2. WEIGH	PRINT	>>

GROSS		0	
kg			
PRESET	NOTES		
kg			
CUSTOMER			
SUPPLIER			
MATERIAL			
VEHICLE		FREE PLATE	
→0←	WAITING...		→0←
1. WEIGH	2. WEIGH	PRINT	>>

Application program

USE	The indicator has a memory area designated for the development of completely customised programs, in order to further integrate the scale into the customer's production system. This important feature increases the versatility of the weight indicator you have purchased and allows you to expand the potential of the weighing system at any time. The standard programming language includes a number of preset features and all the necessary commands.
ACTIVATION	Application programs can be created by software experts.

Customising the communication protocol

USE	Allows you to interface the weight indicator with existing PC programs without changing the existing communication protocol. This function is essential in modernising installations or replacing discontinued scales or scales with limited functions of any brand with which there is communication with PC, PLC or company IT system. Customisation applies both to outgoing strings and incoming commands.
ACTIVATION	Application programs can be created by software experts.

Example:

Existing indicator

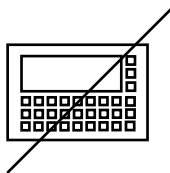

New touch screen indicator



Existing Protocol

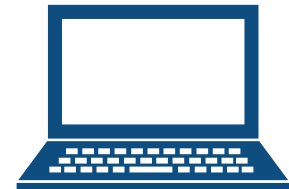
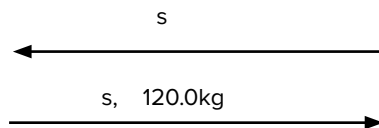

Existing Protocol

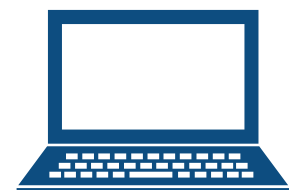
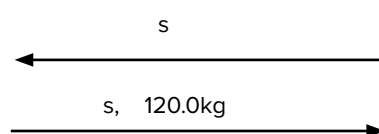

Fully customisable work screens

USE	Allows operators to view only information and operations that are essential to do their jobs correctly and without errors, or to view all the information needed in real time.
APPLICATIONS	Useful to simplify any weighing application.
ACTIVATION	Activation requires advanced configuration.

GROSS		0	
kg			
PRESET	NOTES		
kg	ADDRESS		
NOTES	LOT		
CUSTOMER	MATERIAL		
MATERIAL	SUPPLIER		
VEHICLE	FREE PLATE		
→0←			→0←
1. WEIGH	2. WEIGH	PRINT	>>

GROSS			
kg			
PRESET	NOTES		
kg	ADDRESS		
CITY	LOT		
DRIVER	MATERIAL		
MATERIAL	SUPPLIER		
VEHICLE	FREE PLATE		
→0←			→0←
1. WEIGH	2. WEIGH	PRINT	>>

GROSS		5000	
kg			
TARE	LOT		
kg			
MATERIAL	OK		
<input type="text"/>			
1. WEIGH		2. WEIGH	
→0←			→0←



The indicator can display images, logos, bar graphs, synoptics, etc. You can also add or remove buttons, hot spots, text boxes.
You can create and customise up to 3 work screens that can be accessed quickly from the main one.

Customising language / texts

USE	You can translate / edit all messages and texts on the scale into the desired language using the “Custom Language Tool” computer program.
APPLICATIONS	Useful to facilitate the operator work.
ACTIVATION	Customising the language requires advanced configuration.



Managed page codes:

- Latin 1
- Greek
- Cyrillic
- Vietnamese

Setpoint / dosage

USE	Allows you to activate one or more digital outputs of the indicator upon reaching a certain weight or when a particular function is completed (weighing, reset, etc.)
APPLICATIONS	Industrial automation.
ACTIVATION	Activation requires advanced configuration.

Example of N.O. setpoint upon reaching a weight with activation of actuators
(traffic lights, bars, lamps, motors, PLCs, valves, applicators, ejectors, etc.)

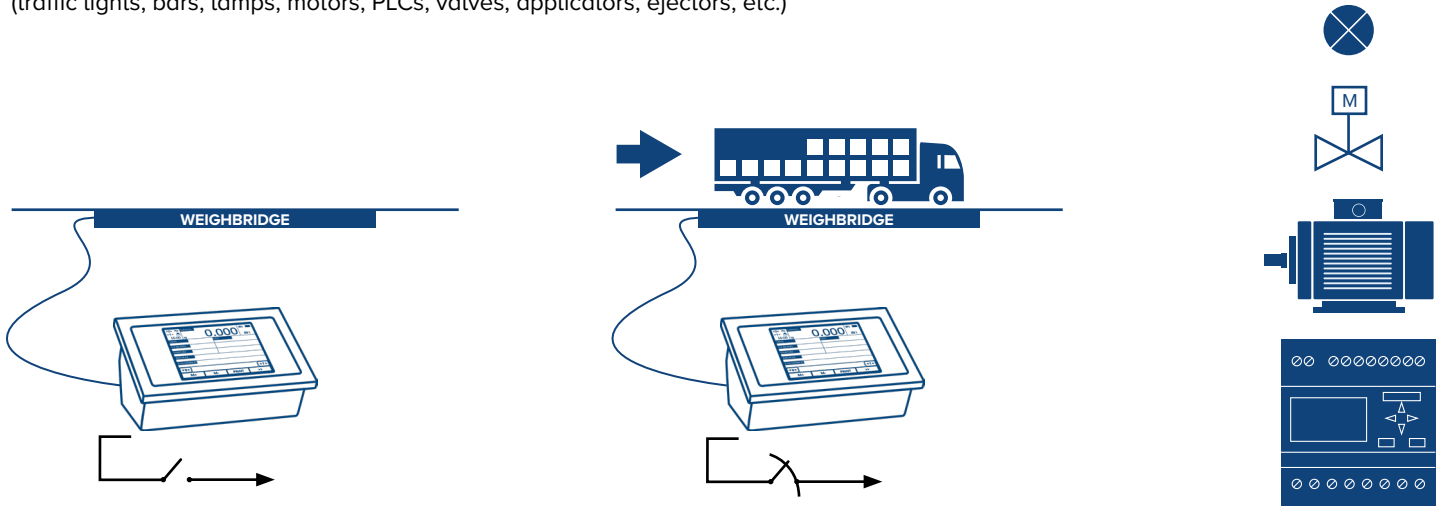

Example of dosing with N.C. setpoint

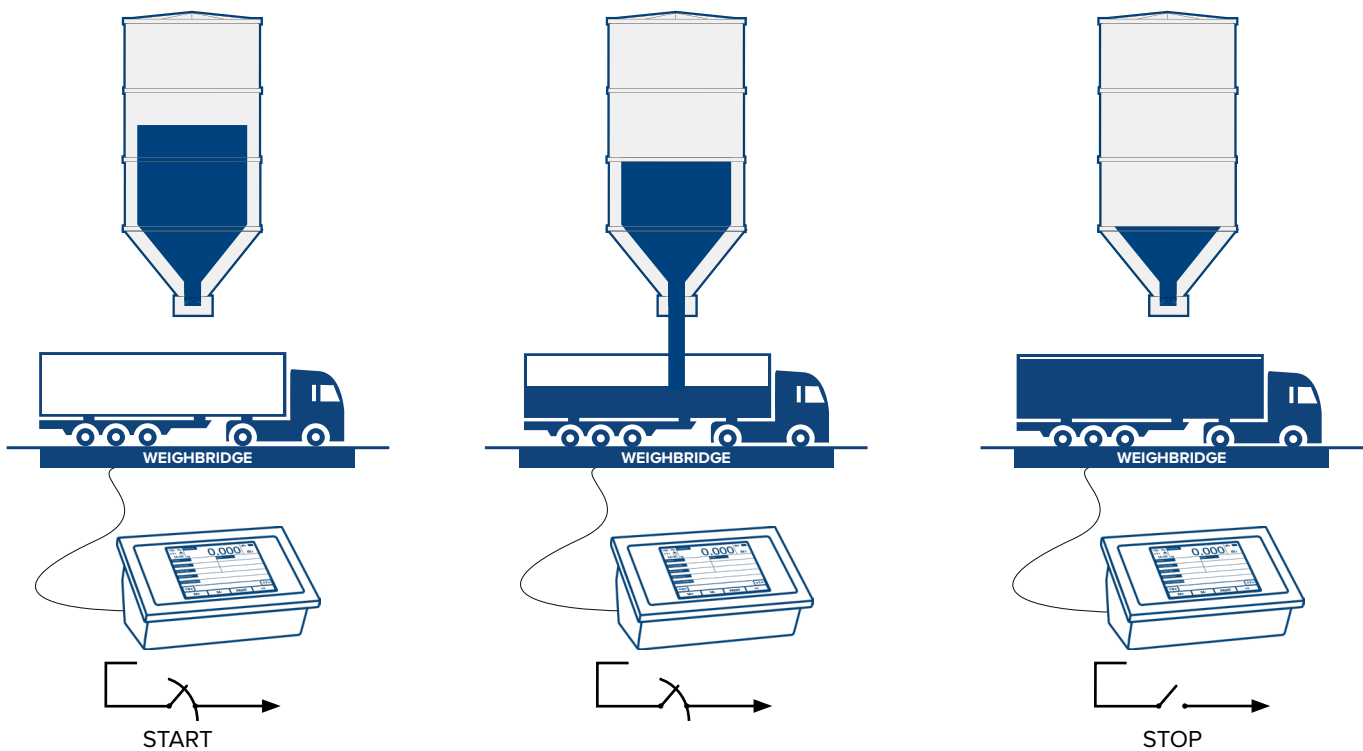

The scale has 4 relay outputs, expandable up to 16 with optional board.

Set the activation thresholds

1.

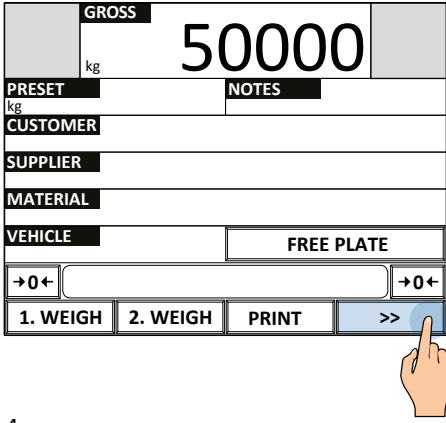

2.

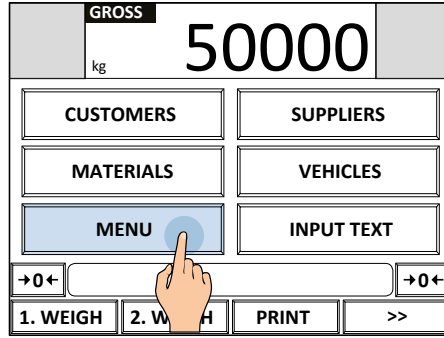

3.

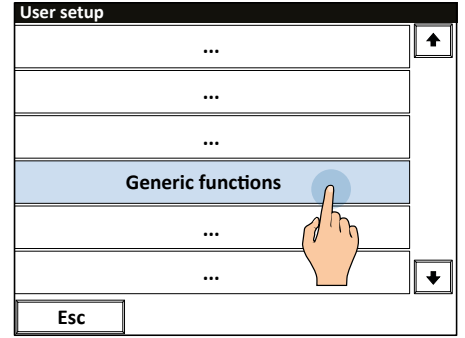

4.

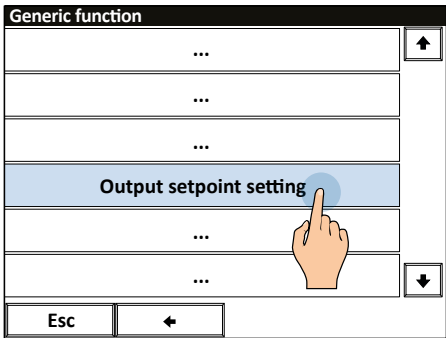

5.

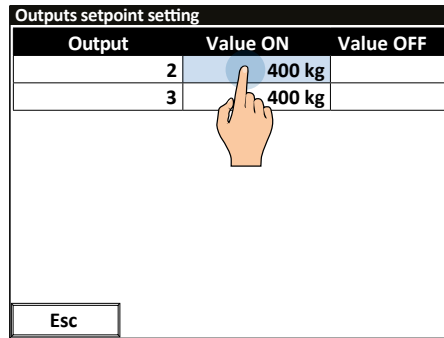

6. Set the activation (and deactivation) value.

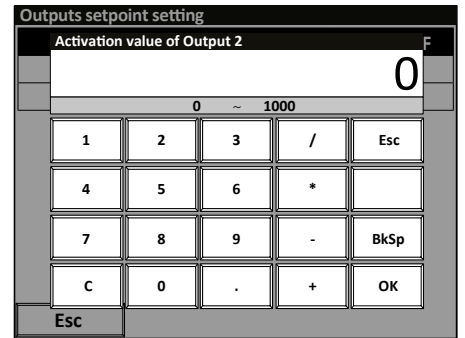

Digital inputs

USE	Allow you to receive digital signals from external devices such as photocells, contacts, PLCs, buttons, pedals, etc. and run the associated function.
APPLICATIONS	Automate weighing cycles.
ACTIVATION	Activation requires advanced configuration.

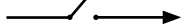
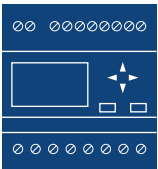

Printing, weighing, relay activation, etc.

Optional analogue interface 4..20mA 0..10V

USE	Allows you to communicate with PLCs or other industrial devices, providing a voltage or current analogue signal proportional to the weight.
APPLICATIONS	Industrial automations.
ACTIVATION	Activation requires advanced configuration.

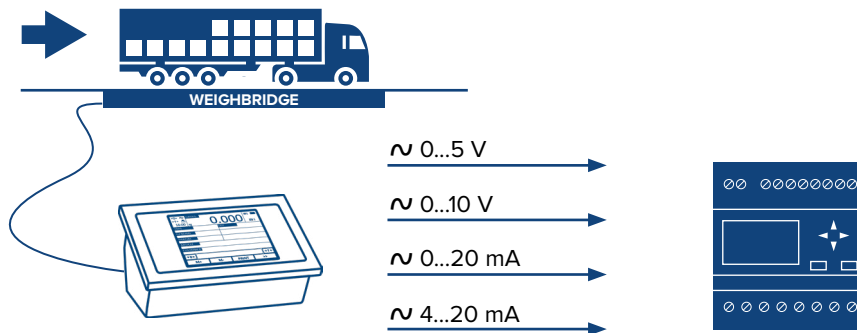

Expanding inputs and outputs

USE	Optional board that allows you expand inputs and outputs to simultaneously communicate with multiple devices, increasing the potentialities of the scale.
APPLICATIONS	Industrial automations.
ACTIVATION	Activation requires advanced configuration.

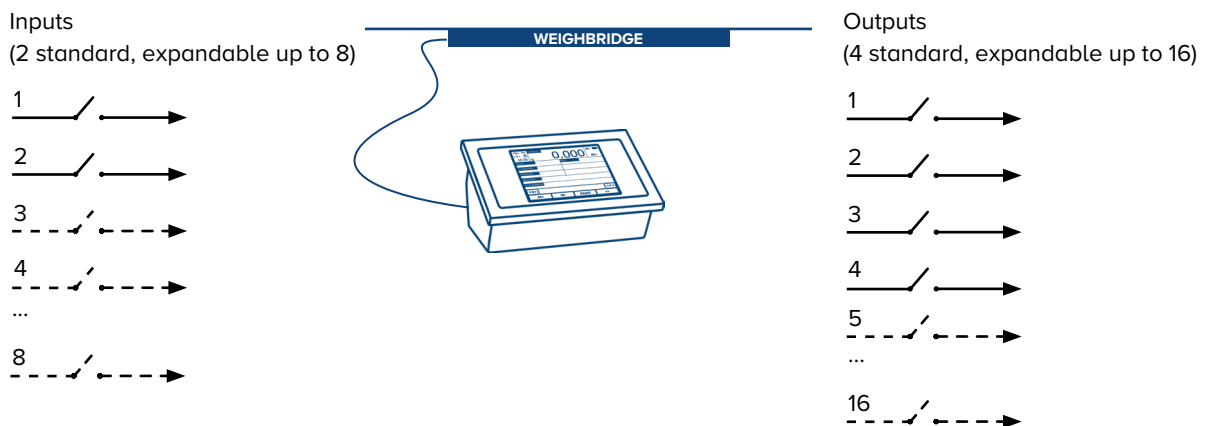

Expansion of power supply range

USE	Optional boards that allows you to power the scale using different voltages than the standard ones.
APPLICATIONS	Industrial automations.
ACTIVATION	Activation requires advanced configuration.

$110/240\text{ Vac}$
 through internal power supply
 or
 12 Vdc
 directed to the motherboard
 or in option
 $8 - 40\text{ Vdc}$
 directed to the motherboard

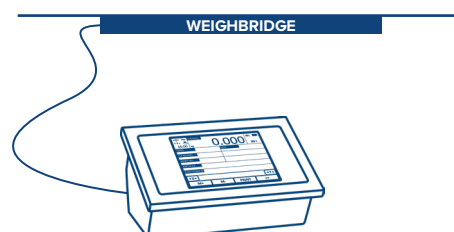

Timed relays

USE	The scale relays can be timed to perform specific functions such as opening and closing of bars or activation of light signals, etc.
APPLICATIONS	Industrial automations.
ACTIVATION	Activation requires advanced configuration.

Example of activating a motor for an established time of 3 seconds following totalisation.

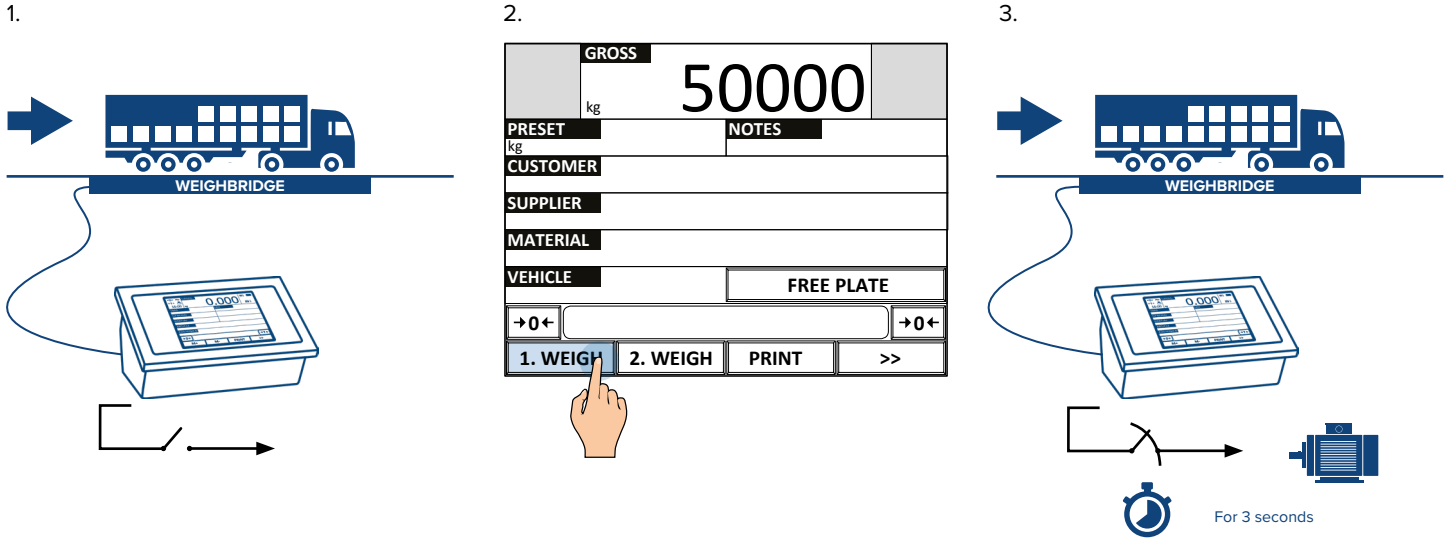

Example of activating a motor delayed by 3 seconds following totalisation.

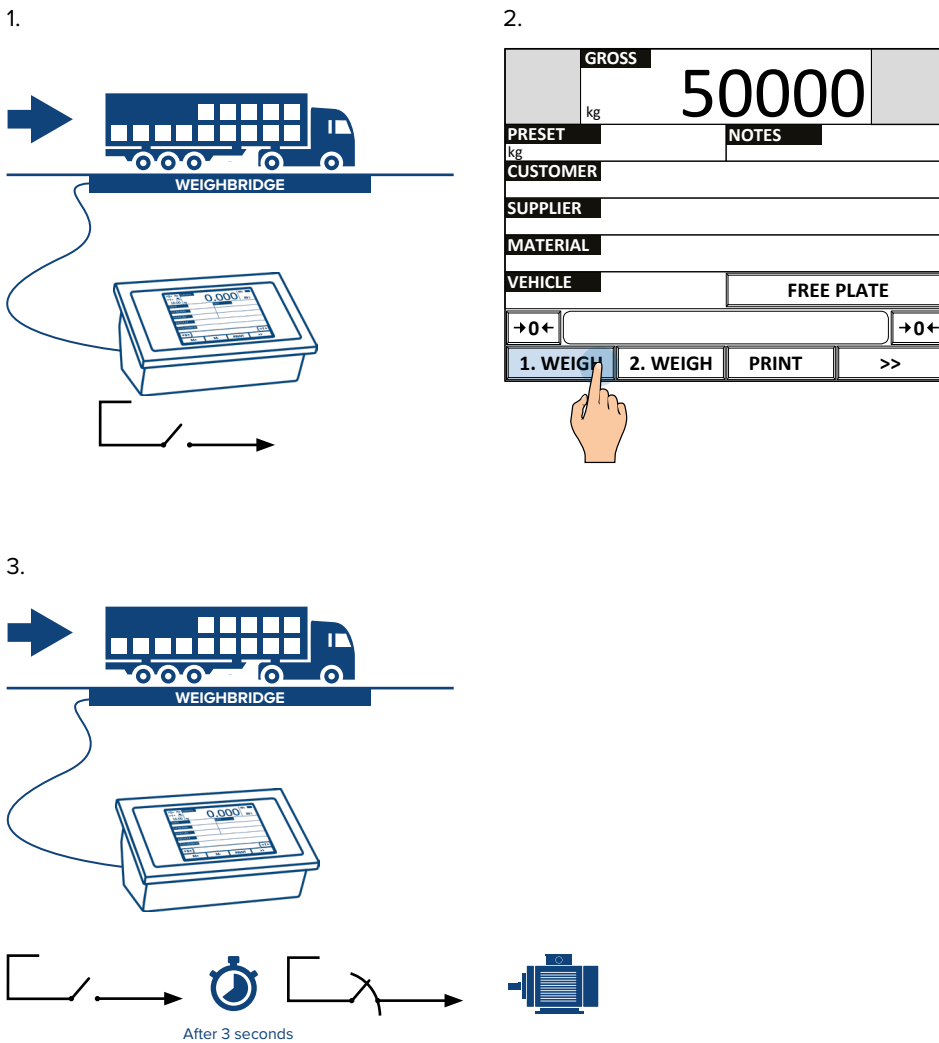

Setting the date and time

ACTIVATION Standard active function.

- 1.
2. Set date and time and press OK to confirm

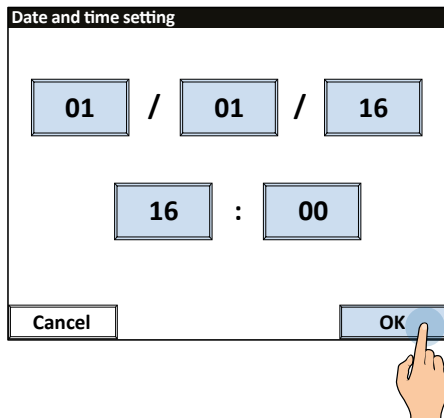
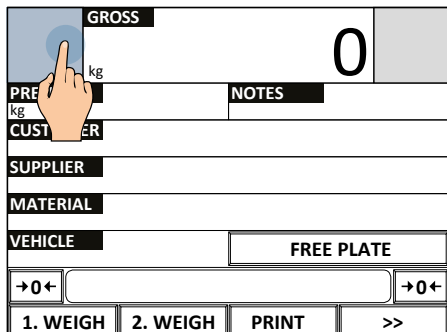

Adjusting the display brightness

ACTIVATION Standard active function.

- 1.
- 2.
- 3.
- 4.
5. Set a brightness value between 1 and 5 and press OK to confirm

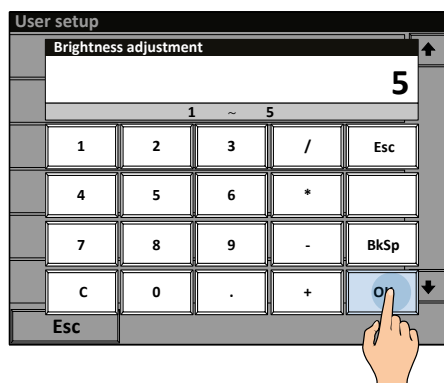
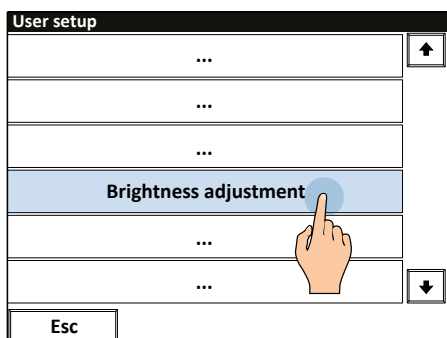
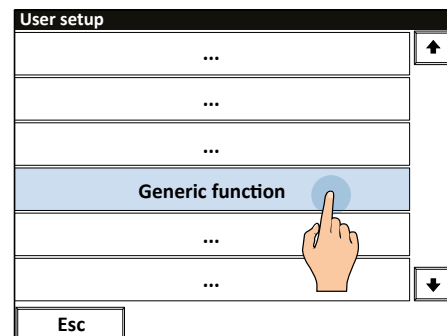
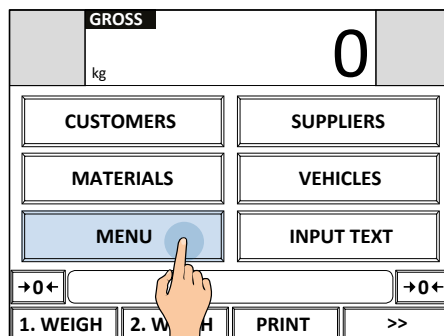
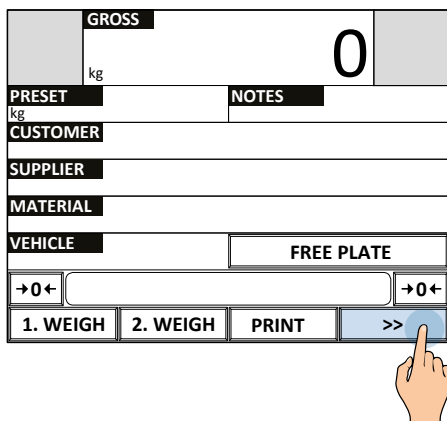

Weighing speed (weighing filter)

USE	Edits scale reactivity. Useful in optimising weighing to your needs.
APPLICATIONS	General weighing.
ACTIVATION	Activation requires advanced configuration.

The available adjustments allow you to maximise weighing speed for the following applications:

Table and floor scales and piece counters

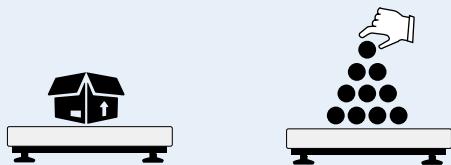

“FLT” type filter

High precision scales



“HR” type filter

Suspended and oscillating load weighing



“DYN” type filter

Metering, filling, level check and overloads

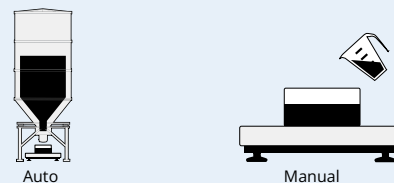

“DOS” type filter

Weighing live animals

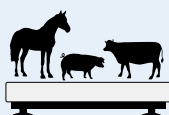

“HOLD” type filter

Special weighing applications

Fully programmable “CUSTOM” type filter, for use by the manufacturer.

Liquid weighing, weighbridges and weighing with vibrations



“SLOW” type filter

Visual weight check in multiple colours

USE	Allows you to signal whether the weighbridge is free or occupied and if weighing was performed successfully.
APPLICATIONS	Self service working modes.
ACTIVATION	Standard active function.

Example of weigh

- 

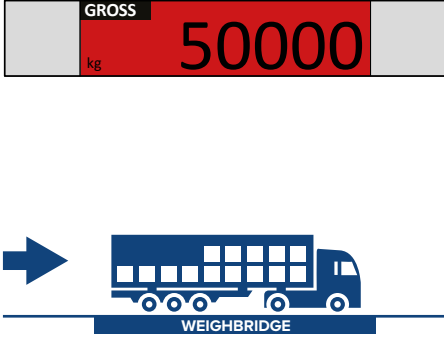
The display shows 0 kg with a green background.
- 

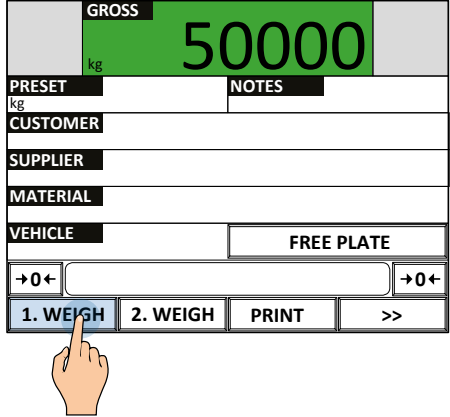
The display turns red to indicate that the weighbridge is occupied. A truck icon is shown on the weighbridge.
- 

If the weighing was performed properly the display lights up green. The menu screen shows options like 1. WEIGH, 2. WEIGH, PRINT, and >>.

How to activate/deactivate the function

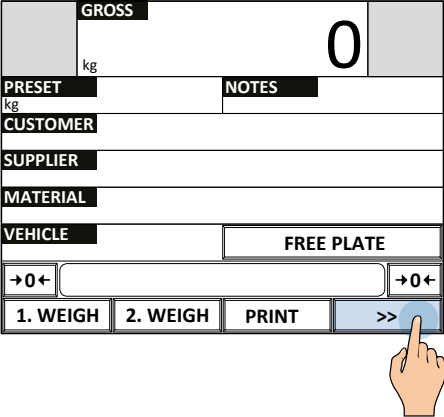
- 

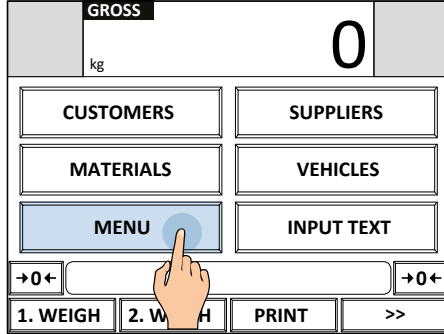
The main menu screen is shown with the MENU button highlighted.
- 

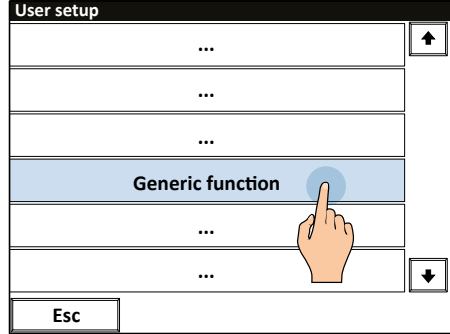
The main menu screen is shown with the MENU button highlighted.
- 

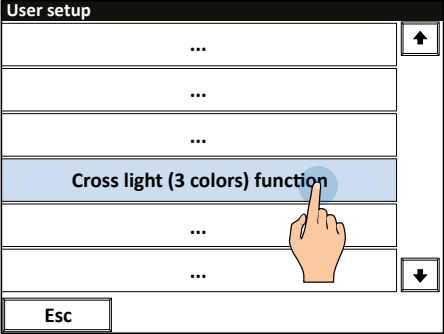
The User setup screen is shown with the Generic function option highlighted.
- 

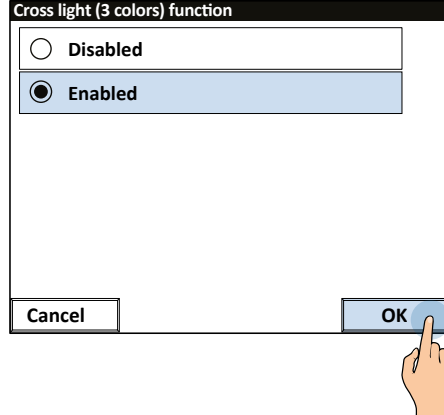
The User setup screen is shown with the Cross light (3 colors) function option highlighted.
- 

The Cross light (3 colors) function dialog box is shown with the Enabled option selected.

i This procedure also enables the three-colour light device, if any.

How to set the threshold below which the weighbridge is free

1.

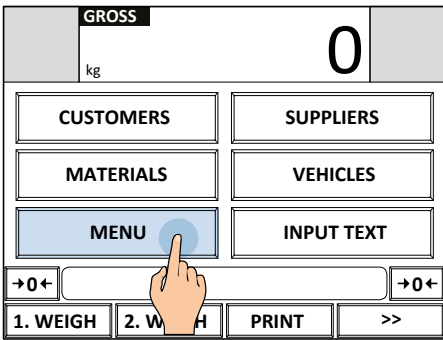

2.

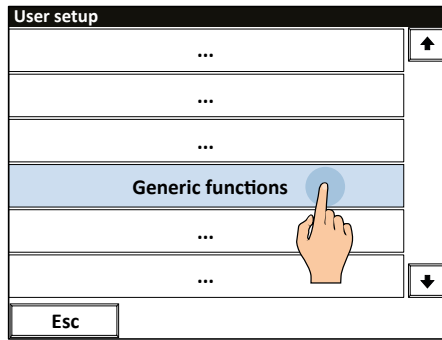

3.

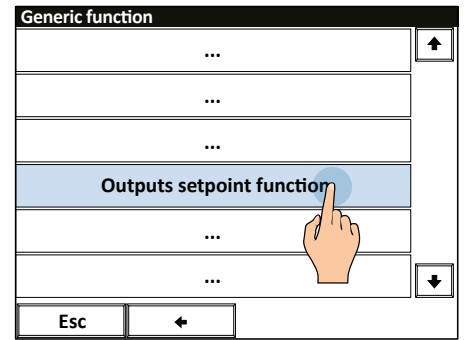

4.

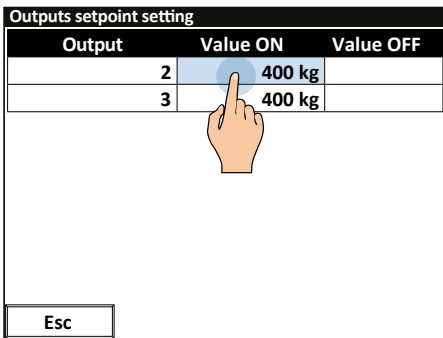

5. Enter the threshold and press OK to confirm

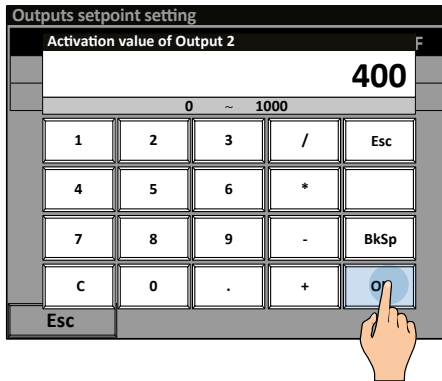

i The “Output 2” threshold is automatically also copied in “Output 3”.

Identification of the metrological software

1.

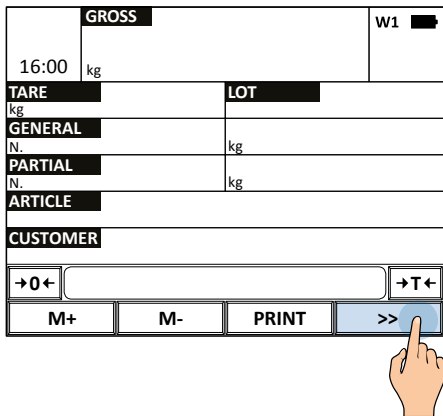

2.

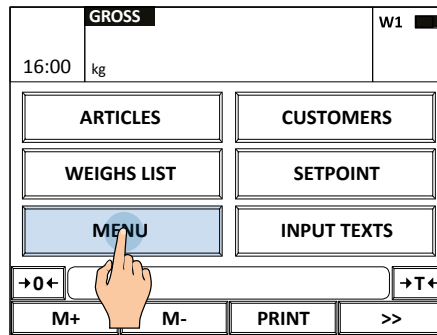

3.

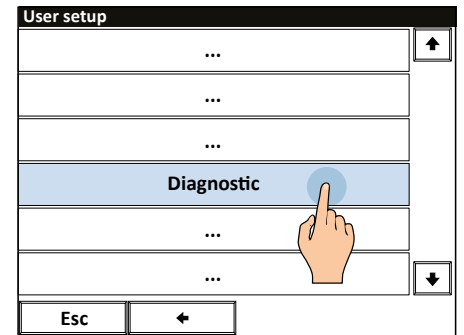

4.

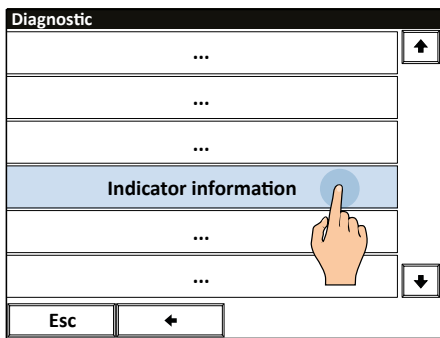

5.

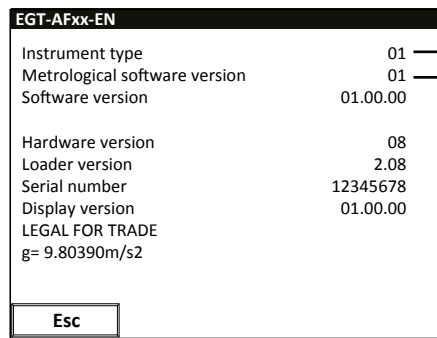

Prefix: instrument model
Version: legal software

FAQ - Frequently Asked Questions

PRINT

The scale does not print

- Another printout is already in progress
- Make sure there is a roll in the printer
- The printer does not switch on
- The weight is unstable
- The net or gross weight is negative or insufficient for printing
- Underload or overload (_____o_____)
- The scale was not unloaded after the last printing
- You are trying to print a non-approved weight

WEIGHING

The scale does not switch on

- Make sure the power cable is connected properly
- Connect the battery charger and try again. If the instrument continues to malfunction, contact the dealer.

The scale switches off suddenly

- Standby mode active, press on the touch screen to reactivate the display
- Automatic switching off active
- Low battery
- Battery failure
- Power supply line failure

The scale is not reactive

- One of the available energy saving modes has been activated
- An unsuitable weighing filter has been selected

At switch-on, the scale displays the “reset in progress” message

- The scale is unable to automatically reset the weight because it exceeds the maximum resettable weight at switch-on. Free the plate, turn the scale off and try again. If the scale continues to have the same problem even when there is nothing on it, contact the dealer.

The weight is unstable

- Check whether the weighing filter is active.
- If the support surface is subjected to vibrations from machinery or moving vehicles, move the scale onto another surface and try again.



Authorised service centre stamp

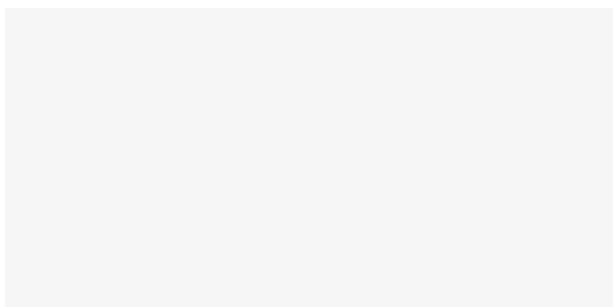

HEAD OFFICE

Via Della Fisica, 20
41042 Spezzano di Fiorano, Modena - Italy
Tel. +39.0536 843418 - Fax +390536 843521
info@diniargeo.com

SERVICE ASSISTANCE

Via Dell'Elettronica, 15
41042 Spezzano di Fiorano, Modena - Italy
Tel. +39.0536 921784 - Fax +390536 926654
service@diniargeo.com