



KERN & Sohn GmbH

Ziegelei 1
D-72336 Balingen
E-Mail: info@kern-sohn.com

Phone: +49-[0]7433- 9933-0
Fax: +49-[0]7433-9933-149
Internet: www.kern-sohn.com

Operating instructions Precision balance

KERN FES / FEJ

Version 1.1
2024-06
GB



TFES_TFEJ-BA-e-2411



KERN FES / FEJ

Version 1.1 2024-06

Operating instructions Precision balance

Contents

1	Technical data	4
2	Declaration of conformity	6
3	Appliance overview	7
3.1	Components	7
3.2	Keyboard	8
3.3	Display	9
3.3.1	Explanation of the display text	10
4	Basic Information (General)	11
4.1	Proper use	11
4.2	Improper Use	11
4.3	Warranty	11
4.4	Monitoring of Test Resources	12
5	Basic Safety Precautions	12
5.1	Pay attention to the instructions in the Operation Manual	12
5.2	Personnel training	12
6	Transport and storage	12
6.1	Testing upon acceptance	12
6.2	Packaging / return transport	12
7	Unpacking, Installation and Commissioning	13
7.1	Installation Site, Location of Use	13
7.2	Unpacking, Scope of delivery	13
7.3	Placing	15
7.3.1	Mounting the weighing platform with terminal	15
7.3.2	Mounting the weighing platform without terminal	17
7.4	Levelling	18
7.5	Mains connection	18
7.5.1	Turning On the Power	19
7.6	Initial Commissioning	19
7.7	Connection of peripheral devices	19
8	Menu	20
8.1	Menu overview	20
8.2	Navigation in the menu	24
9	Basic Operation	25
9.1	Turn on/off	25
9.2	Zeroing	26
9.3	Taring	26
9.3.1	Deleting the tare value	27
9.4	Setting the weighing unit	28
9.4.1	Supported weighing units	29
9.5	Selection of a weighing application	29
9.6	Simple weighing	30
9.7	Changing the display and function keys	30
9.8	Numeric entry	31
10	Piece counting	33
10.1	Select the piece counting function	33

10.2	Actual value setting method: Weighing the reference sample quantity.....	34
10.3	Numerical input of the piece weight.....	35
10.4	Other functions.....	35
11	Percent weighing	37
11.1	Selecting the percent weighing function	37
11.2	Other functions.....	38
12	Coefficient multiplication	40
12.1	Selecting the coefficient multiplication function	40
12.2	Apply coefficient multiplication	40
12.3	Other functions.....	41
13	Weighing with tolerance range	42
13.1	Selection of weighing function with tolerance range	43
13.2	Set discrimination condition	44
13.3	Setting the discrimination range	44
13.4	Set discrimination method	44
13.5	Set acoustic signal	45
13.6	Set relay output control	45
13.7	Setting the tolerance values.....	45
14	Totalizing	48
14.1	Select the Totalizing function	48
14.2	Set totalizing method	49
14.3	Using the totalizing function	49
14.3.1	TOTAL-Adding	49
14.3.2	NET-Adding.....	50
14.3.3	Display or clear the total sum:.....	50
15	PRE-TARE	51
15.1	Storing PRE-TARE values	51
15.2	Activate and deactivate stored PRE-TARE values.....	52
15.3	Exit PRE-TARE mode	53
16	Settings for operation and operating behavior	54
16.1	Setting the short commands for weighing applications	54
16.2	Assigning the function keys	55
16.3	Stabilisation waiting time	56
16.4	Bar graph display	56
16.5	Acoustic signal	57
16.6	Background lighting.....	58
16.7	Stability settings.....	58
16.8	Reaction settings.....	59
16.9	Zero-Tracking.....	59
16.10	Simple SCS (Self Counting System)	60
16.10.1	Enabling / disabling Simple SCS	60
16.10.2	Using Simple SCS.....	60
16.11	Multi-range mode	61
16.12	Automatic switch-off function	62
17	User administration and access rights	63
17.1	User administration.....	63
17.1.1	Activate / deactivate password control.....	63
17.1.2	Assign passwords	64
17.2	Logging a user on to the scale	64
17.3	Managing access rights.....	65
17.3.1	Lock keys	65
17.3.2	Lock menu.....	66
17.3.3	Unlock all access locks	66
17.4	Set short commands and functions for users.....	66
18	System Settings	67
18.1	Call System Settings.....	67

18.2	Balance identification number	67
18.3	Date display format	68
18.4	Date and time	68
18.5	Output language	68
18.6	Readability	69
18.7	Adjustment with internal weight at power-up.....	69
18.7.1	Activate internal adjustment at power-up.....	69
18.7.2	Perform internal adjustment.....	70
18.8	Output of the adjustment test result	70
18.9	Automatic power on when connected to mains.....	70
18.10	Restore last tare value.....	71
18.11	Restore factory settings	72
19	Adjustment	73
19.1	Adjustment with external weight	74
19.1.1	Performing the external adjustment	74
19.1.2	Adjustment test with external weight.....	75
19.2	Adjustment with internal weight	76
19.2.1	Performing the internal adjustment	77
19.2.2	Adjustment test with internal weight.....	77
19.3	Setting the adjustment reminder	77
19.4	Position of the adjustment switches and seal marks	78
20	Verification	79
21	Interfaces.....	80
21.1	RS-232C interface for data input and output.....	80
21.1.1	Technical data.....	80
21.1.2	Interface cable.....	81
21.2	RS232C interface for data output	82
21.3	Data Output Formats (CSP).....	82
21.3.1	Data composition	82
21.3.2	Data description	83
21.4	Data output formats (CBM).....	85
21.4.1	Data composition	85
21.4.2	Data description	86
21.5	Data input	88
21.5.1	Input format 1	88
21.5.2	Input format 2	89
21.6	Response formats	90
21.6.1	A00/Exx Format	90
21.6.2	ACK/NAK Format	91
21.7	Communication settings.....	91
21.7.1	Activate / deactivate the RS232-C interface	91
21.7.2	Adjust communication settings.....	92
22	Servicing, maintenance, disposal	96
22.1	Cleaning	96
22.2	Servicing, maintenance	96
22.3	Disposal.....	96
23	Instant help for troubleshooting.....	97
23.1	Error messages	98

1 Technical data

KERN	FES 17K-4	FES 33K-4	FES 62K-4D
Item no./ Type	TFES 17K-4-A	TFES 33K-4-A	TFES 62K-4D-A
Readability (d)	0.1 g	0.1 g	0.1 g, 1 g
Weighing range (max)	17 kg	33 kg	6.2 kg, 62 kg
Reproducibility	0.1 g	0.1 g	0.1 g, 1 g
Linearity	0.3 g	0.3 g	0.3 g, 3 g
Stabilization time	3 s		
Recommended adjustment weight, not added (Category)	10 kg (F1) 5 kg (F1)	20 kg (E2); 10 kg (E2)	50 kg (F1)
Warm-up time	2 h		
Weighing Units	g, kg, ct, lb, oz, ozt, dwt, mom, tlh, tls, tlt, tola		
Smallest part weight during piece counting	100 mg (under lab conditions*)		
	1 g (under normal conditions**)		
Reference unit weights at piece count	5, 10, 30, 50, 100, free		
Weighing plate, stainless steel	400 x 350 x 150 mm		
Dimensions of the housing (B x D x H) [mm]	350 x 520 x 170		
Net weight (kg)	18 kg		
Permissible ambient condition	5 °C to + 35 °C		
Humidity of air	80 %		
Power supply unit input voltage	AC 100-240 V, 50/60Hz		
Scale input voltage	12 V, DC 1.0 A		
Interfaces	RS-232		
Degree of pollution	2		
Overvoltage category	Category II		
Metres in height	Up to 2000 m		
Place of installation	In sealed rooms only		

KERN	FEJ 17K-4M	FEJ 33K-4M	FEJ 62K-4DM
Item no./ Type	TFEJ 17K-4M-A	TFEJ 33K-4M-A	TFEJ 62K-4DM-A
Readability (d)	0.1 g	0.1 g	0.1 g, 1 g
Weighing range (max)	17 kg	33 kg	6.2 kg, 62 kg
Minimum load (Min)	5 g		
Verification value (e)	1 g		
Verification class	II		
Reproducibility	0.1 g	0.1 g	0.1 g, 1 g
Linearity	0.3 g	0.3 g	0.3 g, 3 g
Stabilization time	3 s		
Recommended adjustment weight, not added (Category)	internal		
Warm-up time	2 h		
Weighing Units	g, kg		
Smallest component weight for piece counting	100 mg (under lab conditions*)		
	1 g (under normal conditions**)		
Reference unit weights at piece counting	5, 10, 30, 50, 100, free		
Weighing plate, stainless steel	400 x 350 x 150 mm		
Dimensions caisse (l x L x h) [mm]	350 x 520 x 170		
Net weight (kg)	19 kg		
Permissible ambient condition	5 °C to + 35 °C		
Humidity of air	80 %		
Power supply unit input voltage	AC 100-240 V, 50/60Hz		
Scale input voltage	DC 12 V, 1.0 A		
Interfaces	RS-232		
Degree of pollution	2		
Overvoltage category	Category II		
Metres in height	Up to 2000 m		
Place of installation	In sealed rooms only		

*** Smallest component weight for piece counting - under lab conditions:**

- There are ideal ambient conditions for high-resolution counting
- The parts to be counted are not scattered

**** Smallest component part for piece counting – under normal conditions:**

- There are unsteady ambient conditions (draft, vibrations)
- The parts to be counted are being scattered

2 Declaration of conformity

The current EC/EU Conformity declaration can be found online in:

www.kern-sohn.com/ce

i For verified weighing scales (= weighing scales assessed for conformity) the declaration of conformity is included in the scope of delivery.

3 Appliance overview

3.1 Components

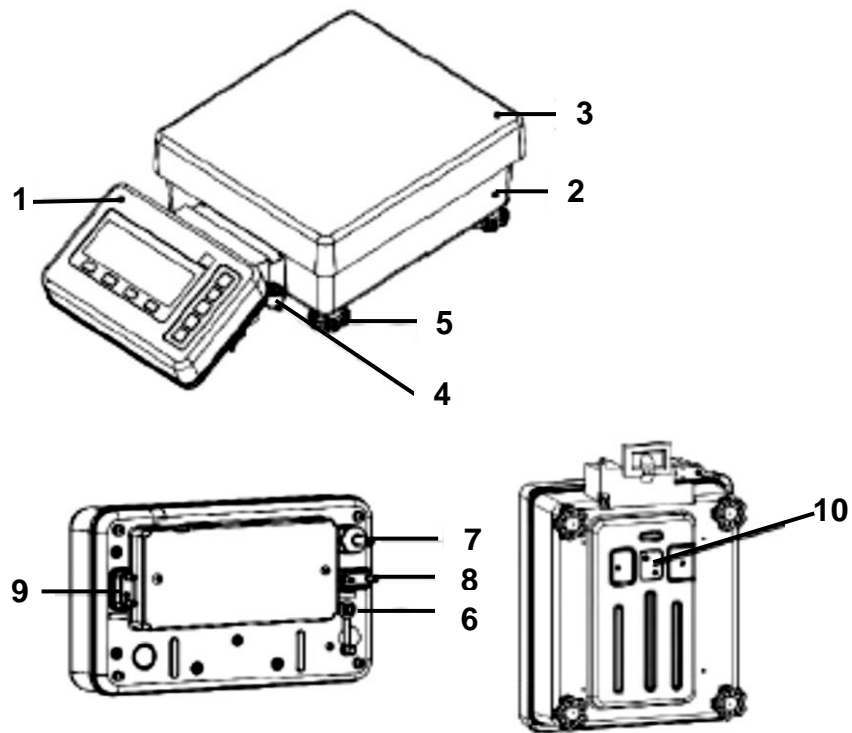

Pos.	Designation
1	Terminal
2	Weighing unit
3	Weighing plate
4	Bubble level
5	Levelling screw
6	Mains connection
7	Scale cable
8	RS-232C interface
9	Connection for peripheral devices
10	Cover hook for underfloor weighing

3.2 Keyboard

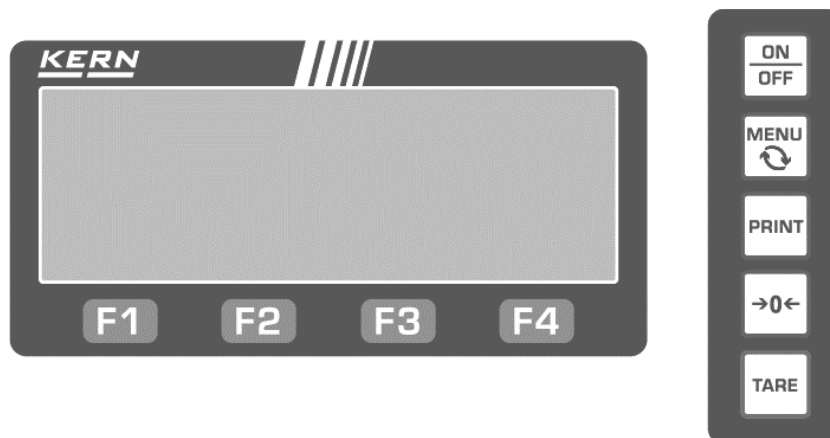

Button	Designation	Description
	[ON/OFF]	Switch-on Switch off (hold down for about 2 seconds)
	[MENU]	Open and close menu Cancel input and return to menu
	[PRINT]	Data export to external device
	[ZERO]	Zeroing
	[TARE]	Taring
	[F1]	▼ Select mode, function and element
		↑ Select menu items or increase numeric entry by 1
	[F2]	▼ Select mode, function and element
		↓ Select menu items or decrease numerical input by 1
	[F3]	▼ Select mode, function and element
		← Switch to higher menu level or select digit
	[F4]	▼ Select mode, function and element
		→ Move to lower menu level or select digit
		↵ To confirm or exit the current selection Return to the menu or into weighing mode

3.3 Display

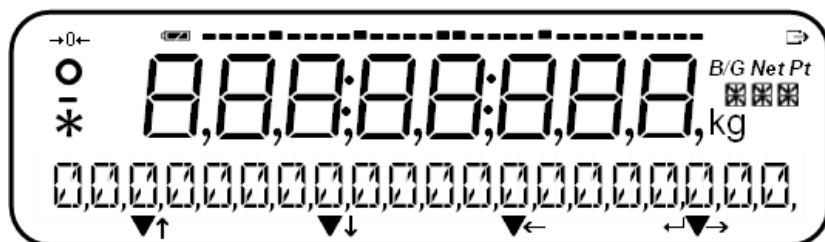

No.	Display	Designation	Description
1	—	Minus	Displays negative values
2	○	Stability display	Is displayed when the weight value is stable
3	→0←	Indicator “zero display”	Displays zero position
4	8	7-segment	To display the weight value and characters
5	🔋	Charge status display	Displayed during battery operation
6	➡	Indicator „Data output”	Displayed when scale is sending data to external device
7	B/G	Display gross weight value	Displays gross weight
8	Net	Display net weight value	Displayed when tare weight or PRE-TARE value has been subtracted
9	Pt	Preset tare	Displayed when the PRE-TARE value has been subtracted
10	g	Gram	Shows unit „Gramm”
11	kg	Kilogram	Shows unit „Kilogramm”
12	☒☒☒	16-segment message / unit	To display various messages and units
13	↑ ↓ → ← ↙ ▼	Function key action	Displayed when function keys are active
14	:	Colon	To display the date and time
15	*	Asterisk	To display the standby status or in the totalizing function as an indication that weight value can be added.
16	■-----■	Bar graph display	Indicates how much the weighing plate is loaded with respect to the maximum weighing range Indicates the progress of internal adjustment
17*	□	Marking of non-verification-relevant digits	Is displayed for digits that are not relevant to verification

* No. 17 is displayed only on verified balances and scales

3.3.1 Explanation of the display text

A	B	C	D	E	F	G	H	I	J	K	L	M	N	O
A	b	C	d	E	F	G	h	i	J	K	L	M	n	O
P	Q	R	S	T	U	V	W	X	Y	Z	c	comma	point	
P	q	r	s	t	u	v	w	x	y	z	c	,	.	
1	2	3	4	5	6	7	8	9	0	space	minus / hyphen			
1	2	3	4	5	6	7	8	9	0	_	-			

A	B	C	D	E	F	G	H	I	J	K	L	M	N	O
A	B	C	D	E	F	G	H	I	J	K	L	M	N	O
P	Q	R	S	T	U	V	W	X	Y	Z				
P	Q	R	S	T	U	V	W	X	Y	Z				
b	c	d	g	l	m	n	o	t	w					
b	c	d	g	l	m	n	o	t	w					
1	2	3	4	5	6	7	8	9	0					
1	2	3	4	5	6	7	8	9	0					
asterisk	slash	left arrow	right arrow	space	plus	minus / hyphen								
*	/	←	→	_	+	-								
comma	point	percent	Degree Celsius											
,	.	%	°C											

4 Basic Information (General)

4.1 Proper use

The balance you purchased is intended to determine the weighing value of material to be weighed. It is intended to be used as a “non-automatic balance”, i.e. the material to be weighed is manually and carefully placed in the center of the weighing pan. The weighing result can be read off once a stable weight value has been reached.

4.2 Improper Use

- Our balances are non-automatic balances and not provided for use in dynamic weighing processes. However, the balances can also be used for dynamic weighing processes after verifying their individual operative range, and here especially the accuracy requirements of the application.
- Do not leave permanent load on the weighing pan. This may damage the measuring system.
- Impacts and overloading exceeding the stated maximum load (max) of the balance, minus a possibly existing tare load, must be strictly avoided. Balance may be damaged by this.
- Never operate the balance in explosive environment. The serial version is not explosion protected.
- The structure of the balance may not be modified. This may lead to incorrect weighing results, safety-related faults and destruction of the balance.
- The balance may only be used according to the described conditions. Other areas of use must be released by KERN in writing.

4.3 Warranty

The warranty becomes void if:

- Our conditions in the operation manual are ignored
- The appliance is used beyond the described uses
- The appliance is modified or opened
- Mechanical damage or damage by media, liquids, natural wear and tear
- The appliance is improperly set up or incorrectly electrically connected
- The measuring system is overloaded

4.4 Monitoring of Test Resources

In the framework of quality assurance the measuring-related properties of the balance and, if applicable, the test weight, must be checked regularly. The responsible user must define a suitable interval as well as type and scope of this test. Information is available on KERN's home page (www.kern-sohn.com) with regard to the monitoring of balance test substances and the test weights required for this. In KERN's accredited DKD calibration laboratory test weights and balances may be calibrated (return to the national standard) fast and at moderate cost.

5 Basic Safety Precautions

5.1 Pay attention to the instructions in the Operation Manual



- ⇒ Carefully read this operation manual before setup and commissioning, even if you are already familiar with KERN balances.

5.2 Personnel training

The appliance may only be operated and maintained by trained staff.

6 Transport and storage

6.1 Testing upon acceptance

When receiving the appliance, please check packaging immediately, and the appliance itself when unpacking for possible visible damage.

6.2 Packaging / return transport



- ⇒ Keep all parts of the original packaging for a possibly required return.
- ⇒ Only use original packaging for returning.
- ⇒ Prior to dispatch disconnect all cables and remove loose/mobile parts.
- ⇒ Reattach possibly supplied transport securing devices.
- ⇒ Secure all parts such as the glass wind screen, the weighing plate, power unit etc. against shifting and damage.

7 Unpacking, Installation and Commissioning

7.1 Installation Site, Location of Use

The balances are designed in a way that reliable weighing results are achieved in common conditions of use.

You will work accurately and fast, if you select the right location for your balance.





On the installation site observe the following:

- Place the balance on a firm, level surface.
- Avoid extreme heat as well as temperature fluctuation caused by installing next to a radiator or in the direct sunlight.
- Protect the balance against direct draughts due to open windows and doors.
- Avoid jarring during weighing.
- Protect the balance against high humidity, vapors and dust.
- Do not expose the device to extreme dampness for longer periods of time. Non-permitted condensation (condensation of air humidity on the appliance) may occur if a cold appliance is taken to a considerably warmer environment. In this case, acclimatize the disconnected appliance for ca. 2 hours at room temperature.
- Avoid static charge of goods to be weighed or weighing container.
- Do not operate in areas with hazard of explosive material or in potentially explosive atmospheres due to materials such as gasses, steams, mists or dusts.
- Keep away chemicals (such as liquids or gasses), which could attack and damage the balance inside or from outside.
- Keep IP protection of the device.
- In the event of the occurrence of electromagnetic fields, static charges (e.g., when weighing / counting plastic parts) and unstable power supply, large display deviations (incorrect weighing results, as well as damage to the scale) are possible. In that case, the location must be changed.

7.2 Unpacking, Scope of delivery

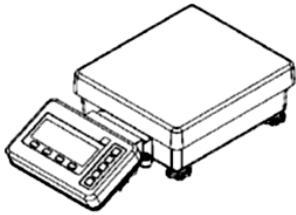
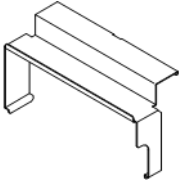
Remove device and accessories from packaging, remove packaging material and install the device at the planned work place. Check if that there has been no damage and that all items of delivery scope are present.

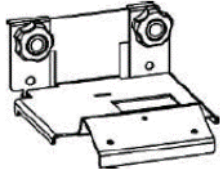
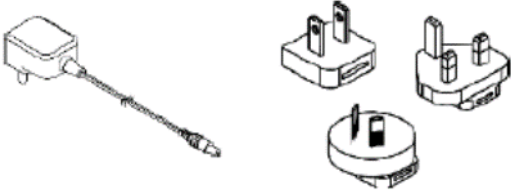
Scope of delivery:

1. Weighing platform with terminal	
2. Cable compartment cover	
3. Cover wall bracket	
4. Wall bracket	
5. Power supply set	
6. Operating instructions	

7.3 Placing



The correct location is a crucial factor in the accuracy of the weighing results of high-resolution precision balances (see chapter 7.1).

7.3.1 Mounting the weighing platform with terminal

1. Remove the weighing plate from the scale

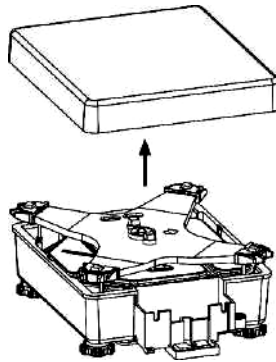

2. Loosen knobs on wall mounting bracket and remove mounting plates

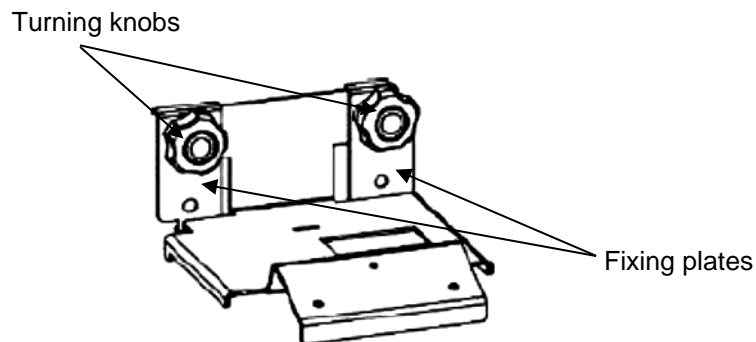

3. Hook wall mounting bracket onto cable compartment from above
4. Hook the fastening plates in front of the cable compartment and tighten them on the wall mounting bracket with the knobs

Make sure that the recesses of the fastening plates are aligned.

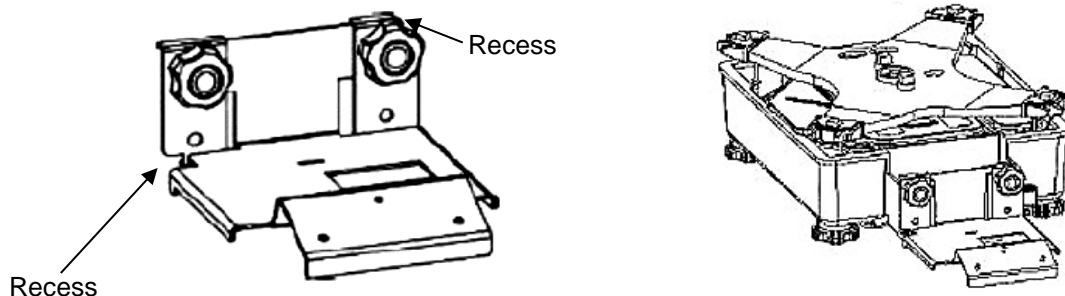

5. Leave 15 cm of the cable on the terminal. Fold the remaining cable and place it in the cable compartment.

6. Apply the cable compartment cover from above, bending the sides slightly outwards.

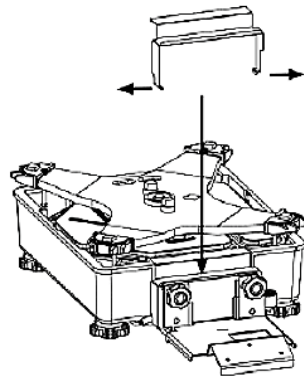

7. Place the weighing plate back on the scale

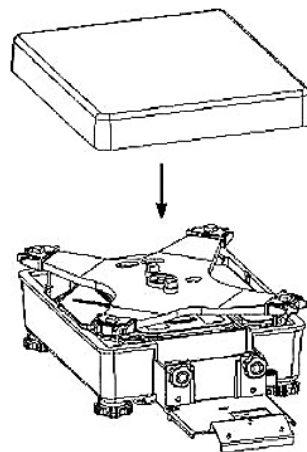

8. Hold the terminal at a slight upward angle and fasten it to the wall mount bracket with the 3 screws and washers.

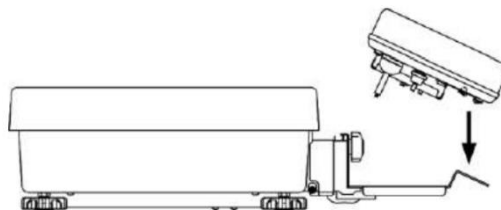

9. Insert the cover of the wall mount bracket from above over the two knobs of the wall mount bracket.

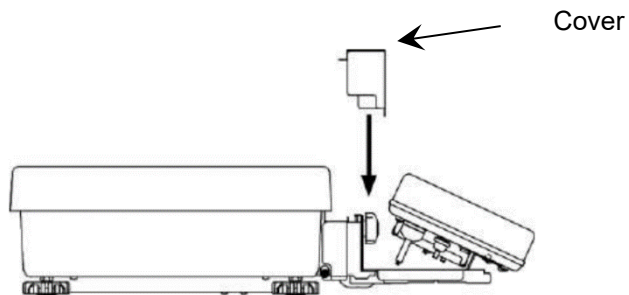

10. Level the scale (see chapter 7.4)

7.3.2 Mounting the weighing platform without terminal

1. Remove the weighing plate from the scale

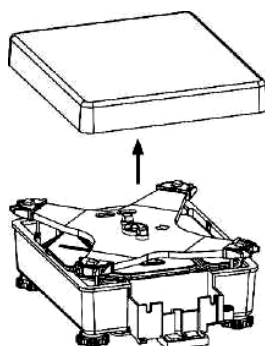

2. Apply the cable compartment cover from above, bending the sides slightly outwards.

3. Place the cover of the wall mounting bracket on the cable compartment

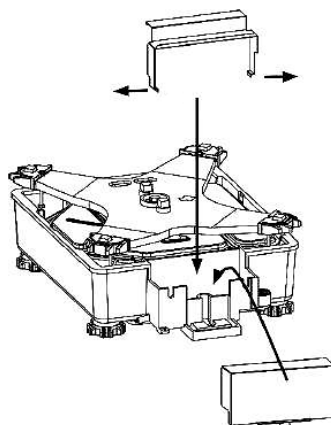

4. Place the weighing plate back on the scale

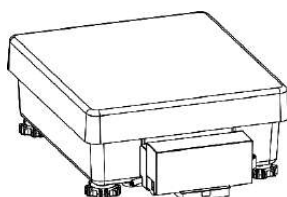

5. Level the scale (see chapter 7.4)

7.4 Levelling

1. Turn the foot screws in the direction of the arrows (see illustration below) to remove the transport locking device

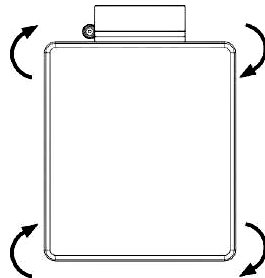

2. Level balance with foot screws until the air bubble of the water balance is in the prescribed circle. Then lock the foot screws with the nuts.

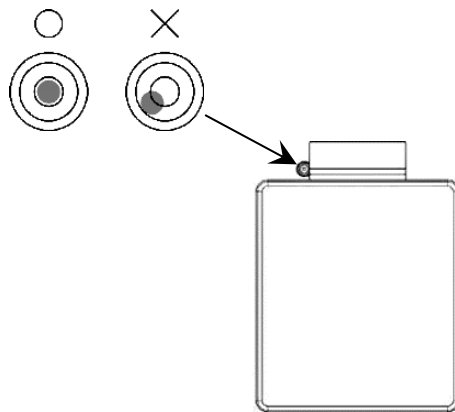

⇒ Check levelling regularly

7.5 Mains connection



Select a country-specific power plug and insert it in the mains adapter.



Check, whether the voltage acceptance on the scales is set correctly. Do not connect the scales to the power mains unless the information on the scales (sticker) matches the local mains voltage.

Only use KERN original mains adapter. Using other makes requires consent by KERN.



Important:

- Before starting your weighing balance, check the mains cable for damage.
- Ensure that the power unit and the mains connection do not come into contact with liquids. Cover the mains connection with the protective cap provided when the balance is disconnected from the mains electricity.
- Ensure access to mains plug at all times.

Connect the power supply unit on the back of the terminal:

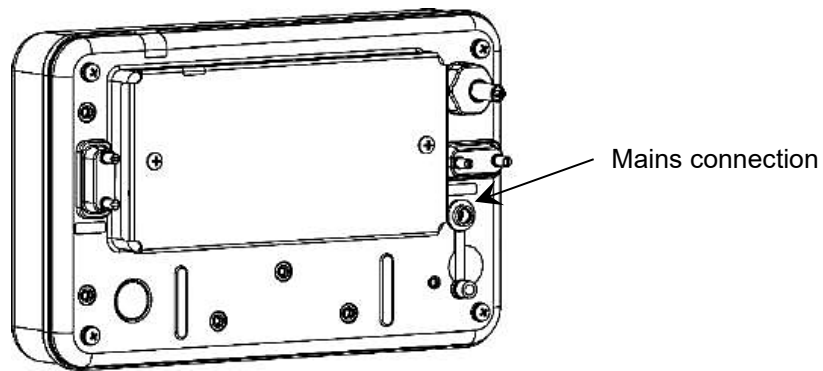

7.5.1 Turning On the Power

	<p>⇒ Connect scale to power supply.</p>
<p>*</p>	<p>⇒ Balance switches to standby mode and an asterisk (*) is displayed</p>

7.6 Initial Commissioning

The scales must have reached their operating temperature for accurate weighing results to be obtained from the electronic scales (see Warm-up Time, Chapter 1). During this warming up time the balance must be connected to the power supply (mains, accumulator or battery). The accuracy of the balance depends on the local acceleration of gravity. It is essential that the instructions in the chapter on Adjustment are followed (see chap.19).

7.7 Connection of peripheral devices

Before connecting or disconnecting of additional devices (printer, PC) to the data interface, always disconnect the balance from the power supply.

Ensure that the connections of the RS-232C interface and the connection for peripheral devices do not come into contact with liquids. Cover the connectors on the device with the protective caps provided when you are not using the connectors.

With your balance, only use accessories and peripheral devices by KERN, as they are ideally tuned to your balance.

8 Menu



The <LOCK> and <ADMIN/ADJUST> menu items can only be accessed by the administrator if password control has been activated on the balance (17.1.1).

8.1 Menu overview

The menu for the scales has four levels. The first level consists of the main menus. The second level consists of submenus. In some cases, these submenus are further subdivided in a third level. The fourth level contains the various setting options for the submenu.

A summary of the individual setting options can be found in the individual chapters.





Level 1 (Main menu)	Level 2 (Submenu 1)	Level 3 (Submenu 2)	Description of the menu / Chapter number	
1 APPLICATIONS	11 MODE		Select weighing application → chap. 9.5	
	12 UNIT		Select weighing unit → Chap. 9.4	
	13 COMPARATOR	131 ACTIVATE		Activate / deactivate tolerance range weighing → Chap. 13.1
		132 CONDITION		Tolerance range weighing Distinguishing condition → Chap. 13.2
		133 RANGE		Tolerance range weighing Distinguishing area → Chap. 13.3
		134 METHOD		Tolerance range weighing Distinguishing method → Chap. 13.4
		135 HI BUZZER		
		136 OK BUZZER		Tolerance range weighing Acoustic signal → Chap. 13.5
		137 LO BUZZER		
	14 ADDITION	141 ACTIVATE		Enable / disable totalizing → Chap. 14.1
		142 OPERATION		Totalizing method → Chap. 14.2
	17 WT STABLE			Stabilisation waiting time → Chap. 16.3
	18 BARGRAPH			Bar graph display → Chap. 16.4
19 BUZZER			Acoustic signal → Chap. 16.5	
1A BACKLIGHT			Background lighting → Chap. 16.6	

	1B AUTO OFF		Automatic switch-off function → Chap. 16.12	
	1C SIMPLE SCS		Simple SCS → Chap. 16.10	
	1D RANGE MODE		Multi-range mode → Chap. 16.11	
2 PERFORMANCE	21 STABLE		Stability settings → Chap. 16.7	
	22 RESPONSE		Reaction settings → Chap. 16.8	
	23 ZERO TRAC		Zero-Tracking → Chap. 16.9	
3 USER INFO	31 PT MODE		PRE-TARE → Chap. 15.2	
	32 PT INPUT	321 PRESET 1		Saving PRE-TARE values → Chap. 15.1
		322 PRESET 2		
		323 PRESET 3		
		324 PRESET 4		
		325 PRESET 5		
	33 COMPARE WEIGHT	331 WEIGHT HIGH		
		332 WEIGHT REF		
		333 WEIGHT LOW		
	34 COMPARE PERCENT	341 PERCENT HIGH		Set tolerance values for different weighing applications → Chap. 13.7
		342 PERCENT REF		
		343 PERCENT LOW		
	35 COMPARE COUNT	351 COUNT HIGH		
		352 COUNT REF		
		353 COUNT LOW		
36 COMPARE MULT	361 MULTIPLY HIGH			
	362 MULTIPLY REF			
	363 MULTIPLY LOW			

4 EXTERNAL I/O	41 RS232C	411 ACTIVATE	Activate/deactivate RS232-C → Chap. 21.7.1	
		412 FORMAT		
		413 CONDITION		
		414 COMPARE		
		415 BAUD RATE		
		416 PARITY	RS232-C: Communication settings → Chap. 21.7.2	
		417 STOP BIT		
		418 BLANK		
		419 RESPONSE		
		41A STATUS		
		41B TIME STAMP		
5 LOCK	51 ALL UNLOCK		Unlock all access locks → Chap. 17.3.3	
	52 KEY LOCK		Lock keys → Chap. 17.3.1	
	53 MENU LOCK	531 OPERATION		
		532 PERFORM		Lock menu → Chap. 17.3.2
		533 USER		
		534 I/O		
6 ADMIN/ADJUST	61 SHORTCUT MODE	611 F1 KEY		
		612 F2 KEY	Assign short commands → Chap. 16.1	
		613 F3 KEY		
	62 FREE KEY	621 F1 KEY		
		622 F2 KEY		Assign function keys → Chap. 16.2
		623 F3 KEY		
		624 F4 KEY		

		625 F5 KEY
		626 F6 KEY
63 MAINTENANCE	631 EX CAL	Adjustment with external weight → Chap. 19.1.1
	632 EX SPAN TEST	External adjustment test → Chap. 19.1.2
	633 INT CAL	Adjustment with internal weight → Chap. 19.2.1
	634 INT SPAN TEST	Internal adjustment test → Chap. 19.2.2
	638 ADVICE CAL	Adjustment reminder → Chap. 19.3
64 SCALE MANAGE	641 SCALE ID	Balance identification number → Chap. 18.2
	642 PASSWORD	Password control → Chap. 17.1.1
	643 SET ADMIN PASS	Assign passwords → Chap. 17.1.2
	644 SET USER PASS	
	645 SPAN OUT	Automatic output of adjustment test results → Chap. 18.8
	646 DATE DISP	Date display format → Chap. 18.3
	647 DATE SETTING	Date and time → Chap. 18.4
	648 TIME SETTING	
	649 PRT LANG	Output language → Chap. 18.5
	64A READABILIT	Readability → Chap. 18.6
	64B START CAL	Internal adjustment at power-on → Chap. 18.7
	64C DIRECT ST	Automatic power-on → Chap. 18.9
	64D STORE TARE	Restore last tare value → Chap. 18.10
64E INITIALIZE	Restore factory settings → Chap. 18.11	

8.2 Navigation in the menu

Button	Function	
	Open menu	
	Close menu	
	↑	Selection up
	↓	Select down
	←	Cancel setting change
		Go back menu level
	→	Select menu item
	↵	Select and deselect setting
		Save input and exit

Switching off:



⇒ Keep **[ON/OFF]** key pressed for about 2 seconds



⇒ The scale switches to standby mode and an asterisk appears in the display: **<*>**

9.2 Zeroing



If you have activated the PRE-TARE mode, this will be terminated by zeroing (see chapter 15.3).

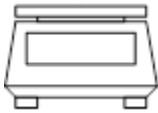

⇒ Unload weighing plate



⇒ Press **[ZERO]** key

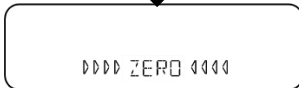

⇒ Scale performs zeroing



⇒ The display shows the value **<0.0 g>** and the zero indication **<→0←>**.

9.3 Taring

The tare weight of any weighing container can be tared at the touch of a button, so that the net weight of the material to be weighed is displayed during subsequent weighing operations.



The **FES** weighing system performs automatic taring during power-up



⇒ Place the empty weighing container on the weighing plate



⇒ The weight of the weighing container is displayed

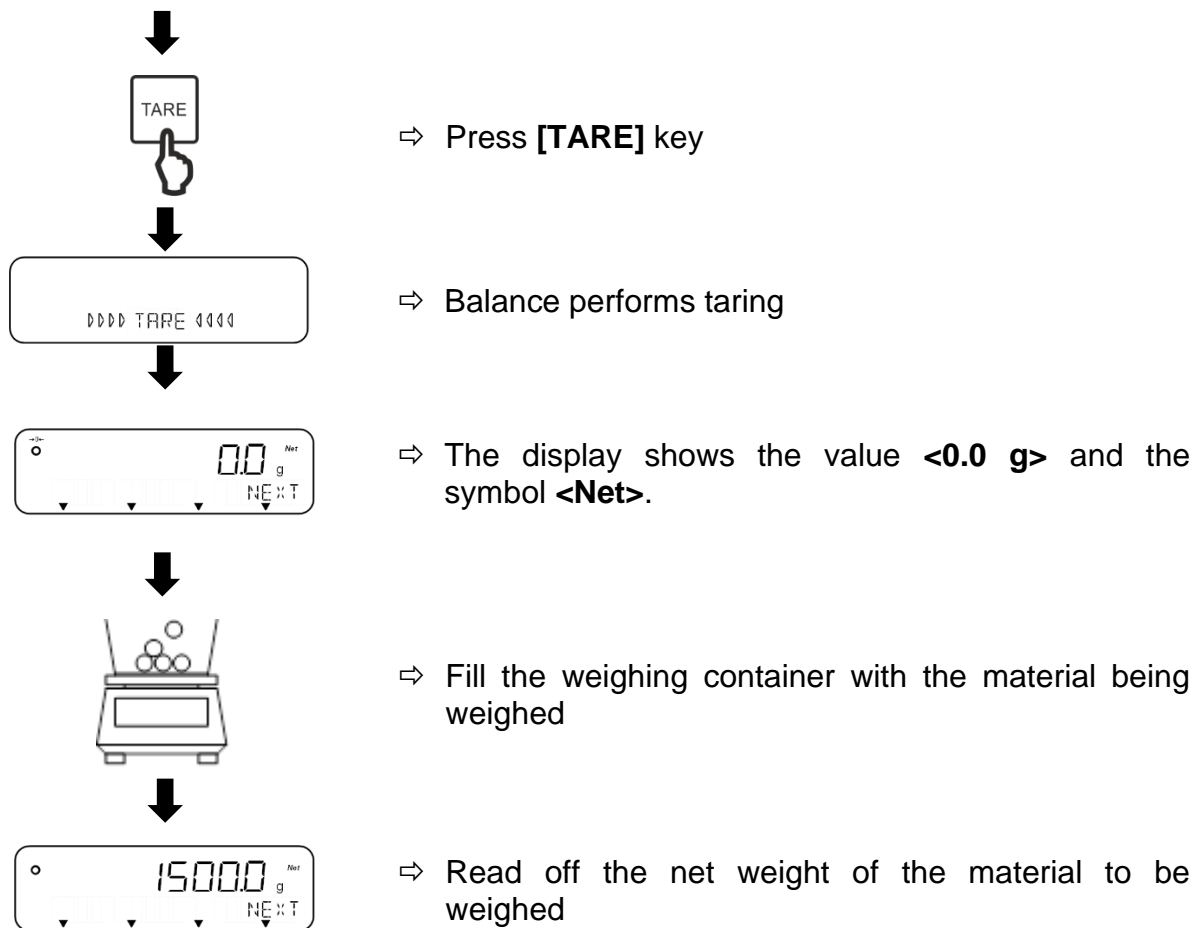

- i**
- When the balance is unloaded the saved taring value is displayed with negative sign.
 - The tare value can be checked using the function keys if this function has been assigned to a key (Assignment of function keys: see chapter 16.2). From the display of the tare value, you can return to the measuring mode by pressing the **[F4]** key.
 - To delete the stored tare value, unload the weighing plate and press the **[TARE]** key or the **[ZERO]** key.
 - The taring process can be repeated any number of times. The limit is reached when the whole weighing range is exhausted.
 - If the tare value is already known, it can be stored as PRE-TARE value (see chapter 15).

9.3.1 Deleting the tare value



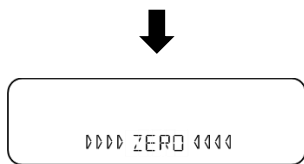

⇒ Scale performs zeroing

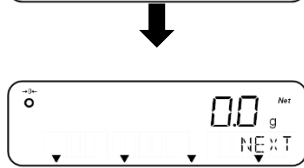

⇒ The display shows the value **<0.0 g>** and the symbol **<Net>**.

9.4 Setting the weighing unit

The FES and FEJ weighing systems support different weighing units (see chapter 9.4.1).



When the scale is switched on, the unit is displayed the scale was using when switched off



⇒ Press **[MENU]** key

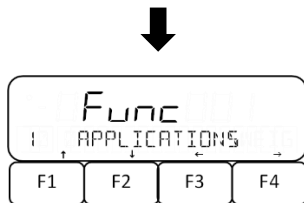

⇒ Use **[F1]** and **[F2]** keys to navigate to **<1 APPLICATIONS>**.

⇒ Press **[F4]** key to go to the application settings.

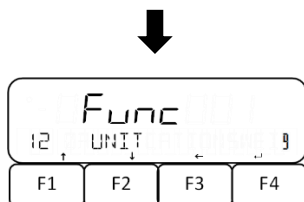

⇒ Use the **[F1]** and **[F2]** keys to navigate to **<12 UNIT>**.

⇒ Press **[F4]** key to navigate to weighing unit selection

⇒ Weighing unit is located at the bottom right of the display and starts flashing

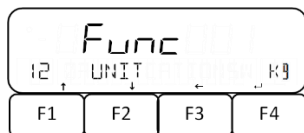

⇒ Use **[F1]** and **[F2]** keys to select desired weighing unit.

⇒ Press **[F4]** key to confirm selection.



⇒ Press **[MENU]** key to return to the weighing mode.

9.4.1 Supported weighing units



The weighing system **FEJ** only supports the weighing units „g“and „kg“

Display	Unit	Display	Unit
g	Gram	LB	Pound
kg	Kilogram	OZ	Ounce
ct	Carat	OZT	Troy ounce
		DWT	Penny weight
		MOM	Momme
		TLH	Tael Hongkong
		TLS	Singapur-Malaysia-Tael
		TLT	Taiwan tael
		TOLA	Indian Tola

9.5 Selection of a weighing application

The FES and FEJ scales have different weighing applications. These are selected in the menu.

The following table lists the available weighing applications the scale can use (✓= available; ✗= not available). More details about the individual weighing applications are described in the respective chapters.

		Simple weighing (see chapter 9.6)	Piece counting (see chapter 10)	Percent Weighing (see chapter 11)	Coefficient multiplication (see chapter 12)
Display on balance		WEIG	COUN	PCNT	MULT
Model	FES	✓	✓	✓	✓
	FEJ	✓	✓	✓	✗

Select a weighing application:



⇒ Press **[MENU]** key

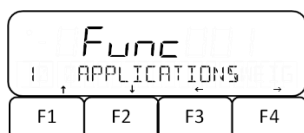

⇒ Use **[F1]** and **[F2]** keys to navigate to **<1 APPLICATIONS>**.

⇒ Press **[F4]** key to go to the application settings.

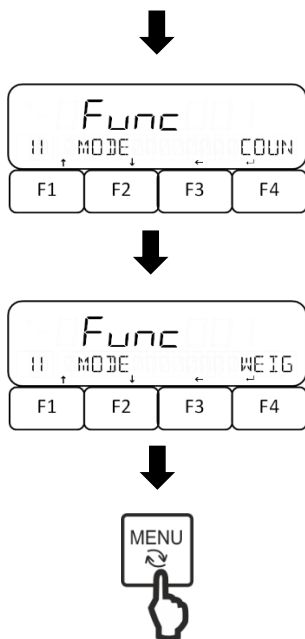

- ⇒ Use **[F1]** and **[F2]** keys to navigate to **<11 MODE>**.
- ⇒ Press **[F4]** key to go to the application selection screen
- ⇒ Weighing application is located at the bottom right of the display and starts flashing
- ⇒ Use **[F1]** and **[F2]** keys to select desired weighing application.
- ⇒ Press **[F4]** key to confirm selection.
- ⇒ Press **[MENU]** key to use selected weighing application.

9.6 Simple weighing

i	If you use a weighing container, tare before weighing (see chapter 9.3).
----------	--

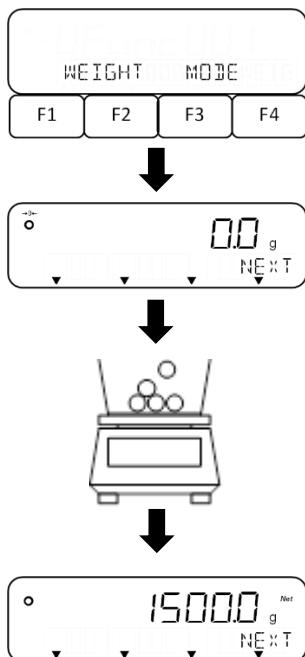

- ⇒ Select weighing application **<WEIG>** (for selection, see chapter 9.5).
- ⇒ Place the weighed material on the weighing plate or in the weighing container.
- ⇒ Read off weighing result

9.7 Changing the display and function keys

The balance has three function keys **[F1]** to **[F3]**. These keys can be assigned short commands for weighing applications (assignment see chapter 16.1).

In addition, these keys can be assigned various functions for simple weighing (for assignment, see chapter 16.2). For the other weighing applications, these functions are already permanently assigned.

While a weighing application is active, up to three functions are shown on the display - these can be used with the keys [F1] to [F3] below (see following figure).

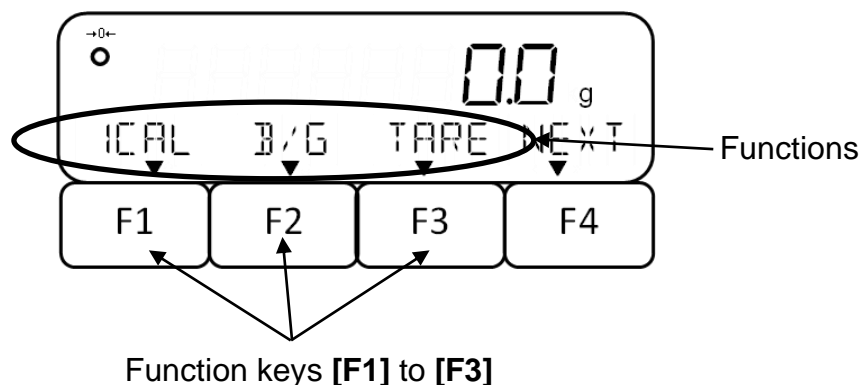

The [F4] key is used to call the next page on the display. There are four display pages in total in each weighing application. When displaying e.g. the time, the [F4] key can be used to return to the measuring mode.

After switching on the scale or leaving the menu, the first page of the display is shown. The display pages are structured as follows:

- 1. to 3rd page: Functions
- 4. Page: Short commands for weighing applications

9.8 Numeric entry

Tolerance limits, reference weight values, piece weight values, PRE-TARE values, coefficients, date / time, balance identification number and passwords can be entered manually on the balance.

i	<ul style="list-style-type: none"> • It is not possible to enter “-” for passwords or IDs. • It is not possible to enter a point for passwords, IDs, time and date. • Whether it is permissible to enter a point for weight values depends on the readability of the scale Example: Readability (d) = 0.1 g → Permissible entry: One decimal place; Inadmissible input: More than one decimal place • The balance can display a maximum of eight digits.
----------	--

Button	Function
	Reject input and return to menu
	Change polarity (“+” or “-“)
	A dot is inserted to the right of the flashing digit
	↑ Increase digit by 1 (after „9“ starts again with „0“)
	↓ Decrease digit by 1 (after „1“ it starts again with „0“)

Button	Function
F3	← Select the digit to be changed
F4	↵ Save input and exit

Enter a numerical value, for example “-5.4321”

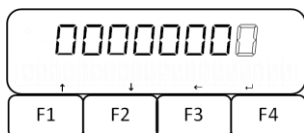

⇒ The digit to be entered flashes.



⇒ Press **[PRINT]** key to set the polarity to “ - “

The input of a value starts with its last digit:

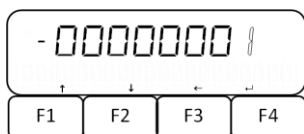

⇒ Press the **[F1]** key to increase the current digit by 1 at a time.

⇒ Press the **[F2]** key to decrease the current digit by 1 at a time.

⇒ Press the **[F3]** key to save the current digit and activate the next digit.

⇒ Repeat this procedure to enter the digits „2, 3, 4, 5“



⇒ Press **[TARE]** key to enter „ . “ .

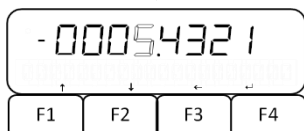

⇒ Press **[F4]** to save the value entered.

10 Piece counting

The **piece counting** application allows you to count several pieces placed on the weighing plate.

Before the balance can count parts, it must know the average part weight (i.e. the so-called reference). Proceed by putting on a certain number of the parts to be counted. The balance determines the total weight and divides it by the number of parts, the so-called reference quantity. Counting is then carried out on the basis of the calculated average piece weight.

As a rule: **The higher the reference quantity the higher the counting exactness.**

Alternatively, the reference weight can be stored in the scale as a value in advance if known.



More accurate piece counting is possible by activating Simple SCS. This function is used with the actual value setting method. For more details on how to activate and use Simple SCS, refer to Chapter 16.10.

Piece can be counted in two ways:

- Actual value setting method: Weighing the reference piece count (see chapter 10.2)
- Numerical input of piece weight (see chapter 10.3)

10.1 Select the piece counting function

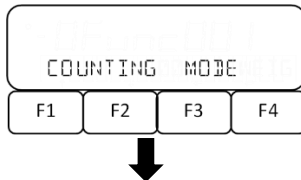

⇒ Select weighing application **<COUN>** (to select see chapter 9.5)

If previous piece counting data is available:

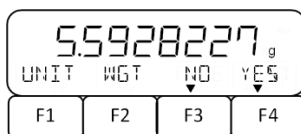

Query whether the last piece weight is to be used again:

⇒ Select the desired setting with **[F3]** and **[F4]**.

NO	Do not import value
YES	Accept value

If no previous piece count data is available or value is not accepted:

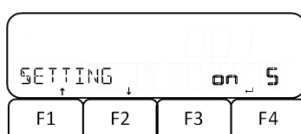

⇒ **<SETTING>** display appears and **<on 5>** flashes.

⇒ Use **[F1]** and **[F2]** to select the reference piece count (see chapter 10.2) or go to numeric entry of the piece weight (see chapter 10.3))

10.2 Actual value setting method: Weighing the reference sample quantity

⇒ Select the reference quantity with **[F1]** and **[F2]**.

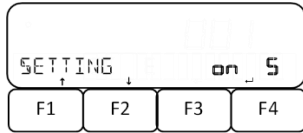

- on 5 | 5 item
- on 10 | 10 item
- on 30 | 30 item
- on 50 | 50 item
- on 100 | 100 item

on VAR | Enter between 1 and 999 pieces (confirm with **[F4]** key and set the number of pieces by pressing **[F1]** and **[F3]** keys).

⇒ Press **[F4]** key to save setting

⇒ The scale will perform an automatic zero setting

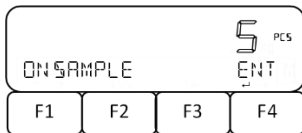

⇒ **<ON SAMPLE>** is displayed and set reference piece count flashes

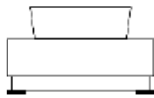

⇒ Place empty weighing container on the weighing plate and press **[TARE]**-key

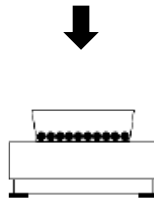

⇒ Place the number of parts in the weighing container according to the entered reference sample quantity.

⇒ Press the **[F4]** key to save the reference weight.



⇒ Place another material to be weighed in the weighing container.

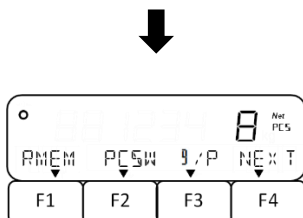

⇒ Read off the piece count

10.3 Numerical input of the piece weight

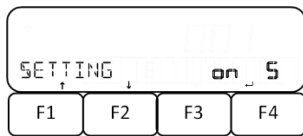

- ⇒ Use the **[F1]** and **[F2]** keys to navigate to **<PCSWGT>**.
- ⇒ Press the **[F4]** key to access the piece weight input screen
- ⇒ Enter the piece weight (Numerical input: see chapter 9.8)
- ⇒ Press **[F4]** key to save setting
- ⇒ The scale will perform an automatic zero setting

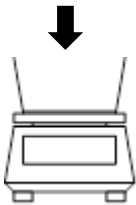

- ⇒ Place empty weighing container on the weighing plate and press **[TARE]**-key



- ⇒ Place the material to be weighed in the weighing container

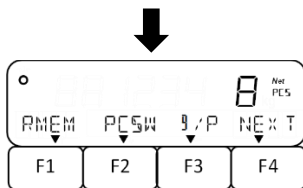

- ⇒ Read off the piece count

10.4 Other functions

Various functions are shown on the display in the piece counting mode, which can be called up and switched through by pressing the keys **[F1]** to **[F4]**:

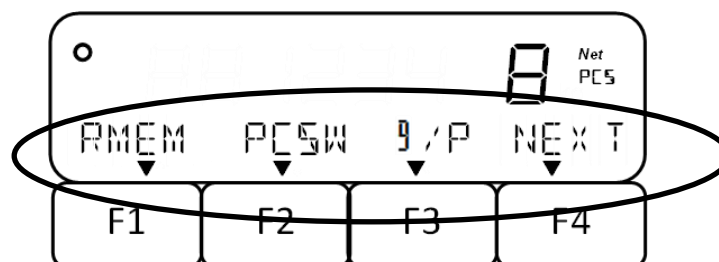

In the following table you will find short descriptions of these functions.

Function	Description	Note
NEXT	Turn page / display additional functions	
RMEM	<ul style="list-style-type: none"> Change reference piece count or piece weight: Press the [F3] key Do not change reference quantity or unit weight: Press the [F4] key 	
PCSW	<ul style="list-style-type: none"> Display piece weight Press [F4] key to return to piece count mode 	
g/P	Toggle display between piece count and total weight	
ADD	Totalize applied sample	<ul style="list-style-type: none"> Only possible if totalizing has been activated For more information, see chapter 14
TOTL	Displaying the total piece count	
LOW	Setting the lower tolerance limit	See chapter 13 for more information on setting the weighing with tolerance range.
OK	Setting the reference value	
HIGH	Setting the upper tolerance limit	
WEIG	Short command: Switch to simple weighing	See chapter 16.1 for more information on setting the short commands
COUN	Short command: Toggle to piece counting	
PCNT	Short command: Toggle to percent weighing	

11 Percent weighing

The **percent weighing** application allows you to check the weight of a sample in per cent in relation to a reference weight.

Sample in per cent, relative to a reference weight.

i	<ul style="list-style-type: none"> If necessary, set to zero (see chapter 9.2) or tare (see chapter 9.3) before weighing. The readability of the balance automatically adjusts to the reference weight: 			
	Readability in %	Weight range of the reference weight		
	1	10 g <=	Reference weight	< 100 g
	0.1	100 g <=	Reference weight	< 1000 g
	0.01	1000 g <=	Reference weight	

The reference weight can be recorded in two ways:

- Actual value setting method: Weighing the **reference** weight
- Numeric entering of the reference weight

11.1 Selecting the percent weighing function

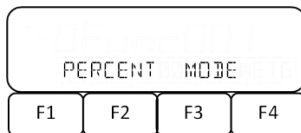

⇒ Select weighing mode **<PCNT>** (for selection see chapter 9.5)



If data on a previous reference weight is available:

Query whether the last reference weight is to be used again:

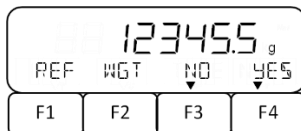

⇒ Select the desired setting with **[F3]** and **[F4]**.

NO	Do not import value
YES	Accept value

If no data on a previous reference weight are available or value has not been stored:

⇒ Display **<SET 100%>** appears

⇒ Select the actual value setting method with the **[F3]** key or go to the numerical input of the reference weight with the **[F4]** key.



onW	Actual value setting method
-----	-----------------------------

NUM	Numeric entering of the reference weight
-----	--



Actual value setting method:

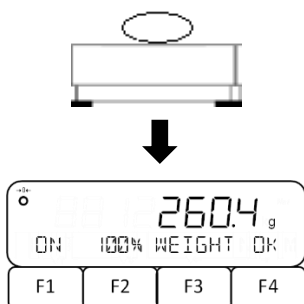

- ⇒ Press **[F3]** key to select <onW>.
- ⇒ Place the reference weight on the weighing plate
- ⇒ Press **[F4]** key to store reference weight

Numerical input of reference weight:

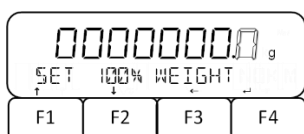

- ⇒ Press **[F4]** key to select <NUM>.
- ⇒ Enter value (Numeric entry: see chapter 9.8)
- ⇒ Press **[F4]** key to store reference weight

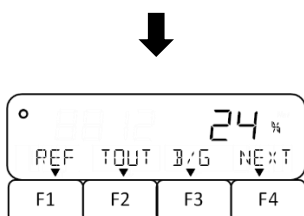

- ⇒ Place material to be weighed onto weighing plate
- ⇒ Percentage based on the reference weight is displayed

11.2 Other functions

Various functions are shown on the display in the piece counting mode, which can be called up and switched through by pressing the keys **[F1]** to **[F4]**:

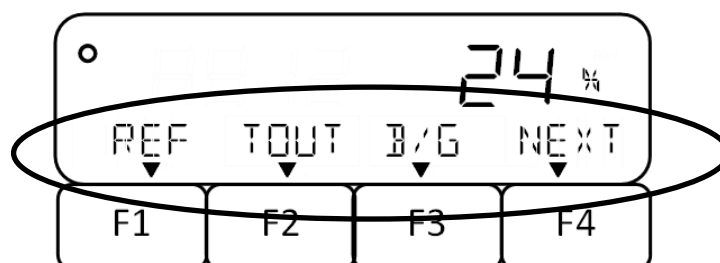

In the following table you will find short descriptions of these functions.

Function	Description	Note
NEXT	Turn page / display additional functions	
REF	<ul style="list-style-type: none"> • Change reference weight: Press the [F3] key • Do not change reference weight: Press the [F4] key 	

Function	Description	Note
TOUT	Edit tare value via interface	
B/G	Display gross percentage	
ADD	Totalize applied sample	<ul style="list-style-type: none"> • Only possible if totalizing has been activated • For more information, see chapter 14
TOTL	Display of the total percentage based on the reference weight.	
LOW	Setting the lower tolerance limit	See chapter 13 for more information on setting the weighing with tolerance range.
OK	Setting the reference value	
HIGH	Setting the upper tolerance limit	
WEIG	Short command: Switch to simple weighing	See chapter 16.1 for more information on setting the short commands
COUN	Short command: Toggle to piece counting	
PCNT	Short command: Toggle to percent weighing	

12 Coefficient multiplication

The **Coefficient multiplication** application allows you to multiply the weight of a sample by a preset value. The result is shown on the display.



This function is only available for the **FES** weighing system.

12.1 Selecting the coefficient multiplication function

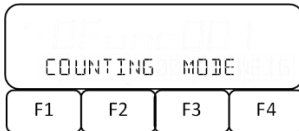

⇒ Select weighing mode **<MULT>** (to select see chapter 9.5).



If data on a previous coefficient is available:

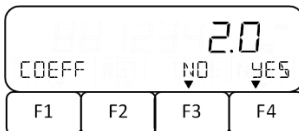

Query whether the last coefficient should be used again:

⇒ Select the desired setting with **[F3]** and **[F4]**.

NO		Do not import value
YES		Accept value

If there are no data on a previous coefficient:

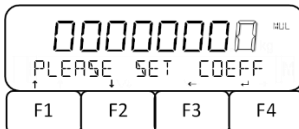

⇒ Display **<PLEASE SET COEFF>** appears.

⇒ Enter coefficients (Numerical input: see chapter 9.8)

12.2 Apply coefficient multiplication



⇒ Place sample on the weighing plate

⇒ Balance multiplies the weight value of the sample by the coefficient

⇒ Read off weighing result

12.3 Other functions

The display shows various functions during coefficient multiplication, which can be called up by pressing the [F1] to [F4] keys:

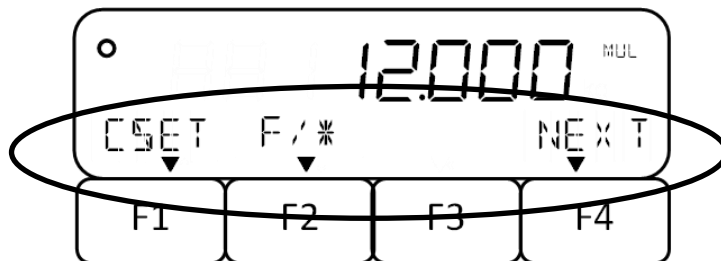

In the following table you will find short descriptions of these functions.

Function	Description	Note
NEXT	Turn page / display additional functions	
CSET	<ul style="list-style-type: none"> Change coefficient: Press the [F3] key Do not change coefficients: Press the [F4] key 	
F	Toggle display between result calculated and total weight.	
ADD	Totalize applied sample	<ul style="list-style-type: none"> Only possible if totalizing has been activated
TOTL	Displaying the total sum	<ul style="list-style-type: none"> For more information, see chapter 14
LOW	Setting the lower tolerance limit	See chapter 13 for more information on setting the weighing with tolerance range.
OK	Setting the reference value	
HIGH	Setting the upper tolerance limit	
WEIG	Short command: Switch to simple weighing	See chapter 16.1 for more information on setting the short commands
COUN	Short command: Toggle to piece counting	
PCNT	Short command: Toggle to percent weighing	

13 Weighing with tolerance range

Setting a tolerance range allows you to quickly check whether a weight value is within certain limits.

You can define either a single tolerance value (either minimum value as lower limit or maximum value as upper limit) or a tolerance range (minimum and maximum value as lower and upper limit).



Weighing with tolerance range is available for the following applications:
Weighing, percent weighing, piece counting and coefficient multiplication.

Whether a measured weight value is within certain limits is indicated on the display in the bottom line by a flashing message (see table below).

			
Evaluation of the weight value	Set tolerance ranges		
	Minimum value only	Maximum value only	Minimum and maximum value
Upper tolerance limit exceeded	OK	HIGH	HIGH
Within the tolerance range	OK	OK	OK
Lower tolerance limit not reached	LOW	OK	LOW

Weight values can be evaluated in two ways when weighing with a tolerance range:

- Evaluation of absolute values
 - The evaluation is based on the permissible maximum and / or minimum value specified.
- Evaluation with difference values
 - The evaluation is based on a specified reference value and the permissible difference values.

Example:

A sample may weigh a minimum of 900.0 g and a maximum of 1200.0 g. The table below shows which values must be specified for the respective differentiation methods.

Distinguishing method	Reference value	Lower tolerance limit	Upper tolerance limit
Absolute values	1000.0 g	900 g	1200.0 g
Differential values	1000.0 g	- 100.0 g	200 g

The following steps must be performed to use weighing in the tolerance range:

1. Select function (see chapter 13.1)
2. Set differentiation condition (see chapter 13.2)
3. Set differentiation range (see chapter 13.3)
4. Set discrimination method (see chapter 13.4)
5. Activate / deactivate acoustic signal (see chapter 13.5)
6. Optional: Set relay output (see chapter 13.6)
7. Set tolerance values (see chapter 13.7)

13.1 Selection of weighing function with tolerance range

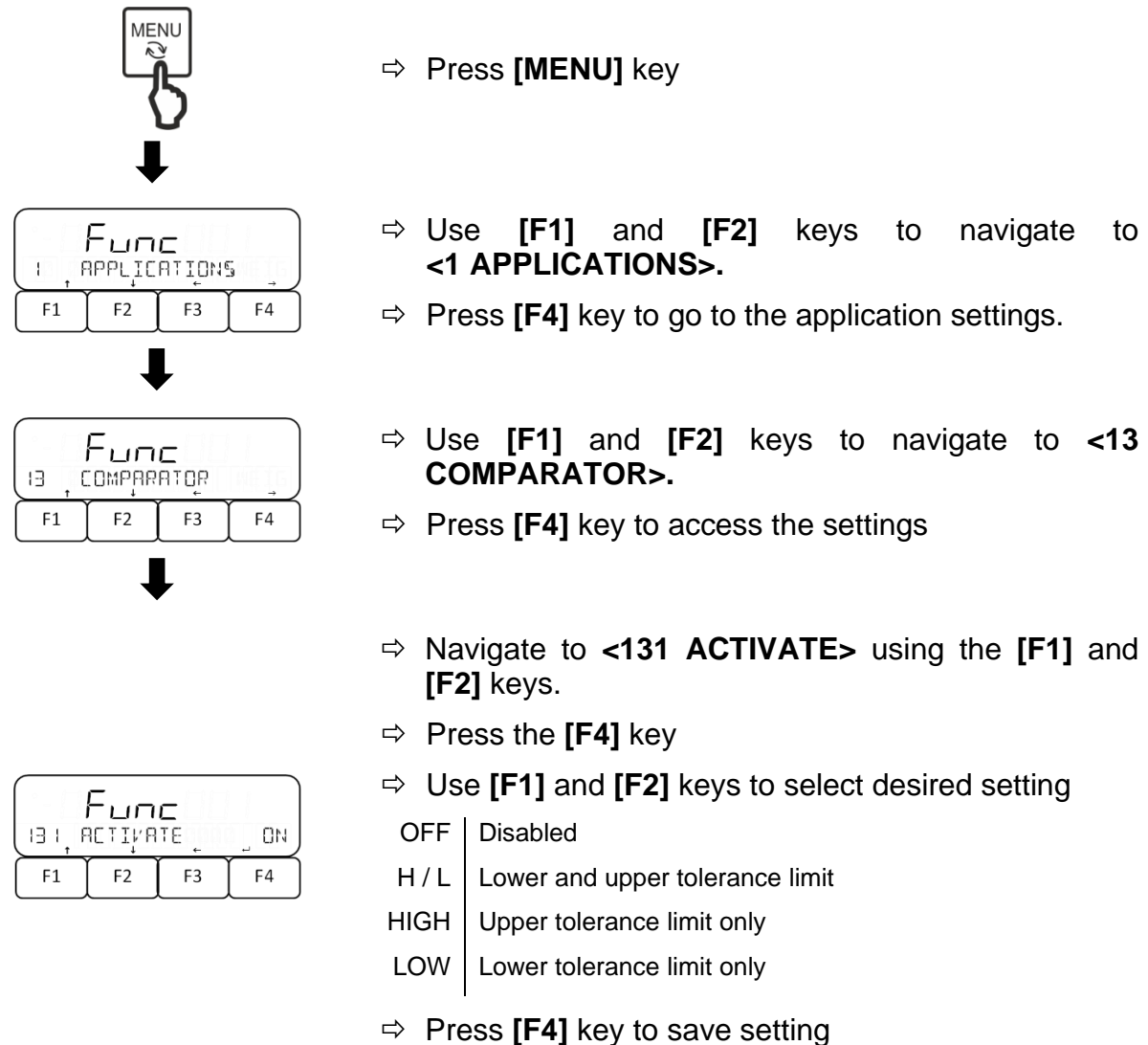

13.2 Set discrimination condition

The discrimination condition defines whether the evaluation of weight values is performed only if there are stable weight values or continuously (in case of fluctuating / non-stable weight values). The continuous assessment of weight values enables you to follow in real time on the display during dynamic weighing processes (e.g. when filling a container) whether your sample is within the tolerance limits.

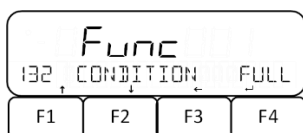

- ⇒ Navigate to **<132 CONDITION>** using the **[F1]** and **[F2]** keys.
- ⇒ Press the **[F4]** key to change the discrimination condition.
- ⇒ Use the **[F1]** and **[F2]** keys to select the desired

FULL	Always
STBL	Only with steady weighing value
- ⇒ Press **[F4]** key to confirm selection.

13.3 Setting the discrimination range

The differentiation range determines the weight value from which the scale starts to evaluate this value. If the entire range is set, the scale starts at 0 g. If 5 is set, the evaluation for the weighing systems is carried out according to the following table:

Model	Minimum weight for assessment
FES 17K-4, FES 33K-4	0.5 g
FES 62K-4D	0.5 g (up to 6.5 kg) or 5 g (up to 65 kg)
FEJ 17K-4M, FEJ 33K-4M, FEJ 62K-4DM	5 g

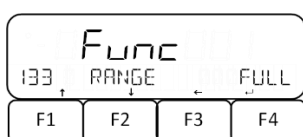

- ⇒ Use **[F1]** and **[F2]** keys to navigate to **<133 RANGE>**.
- ⇒ Press **[F4]** key to change the discrimination range
- ⇒ Use the **[F1]** and **[F2]** keys to select the desired

5	+5 (e/d) or more
FULL	Total range
- ⇒ Press **[F4]** key to confirm selection.

13.4 Set discrimination method

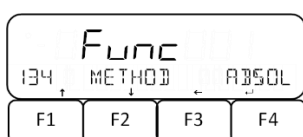

- ⇒ Use **[F1]** and **[F2]** keys to navigate to **<134 METHOD>**.
- ⇒ Press **[F4]** key to change the discrimination method
- ⇒ Use the **[F1]** and **[F2]** keys to select the desired

ABSOL	Evaluation of absolute values
RELAT	Evaluation with difference values
- ⇒ Press **[F4]** key to confirm selection.

13.5 Set acoustic signal



<19 BUZZER> must be activated to use the acoustic signal (see chapter 16.5)

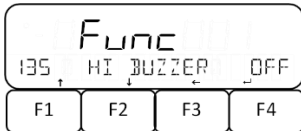

⇒ Navigate to <135 HI BUZZER>, <136 OK BUZZER> or <137 LO BUZZER> using the [F1] and [F2] keys.

- | | |
|---------------|---|
| 135 HI BUZZER | Buzzer for exceeding the upper tolerance limit. |
| 136 OK BUZZER | Buzzer for weighing result being within the tolerance range |
| 137 LO BUZZER | Buzzer for falling below the lower tolerance limit |

⇒ Press [F4] key to change the settings of the acoustic signal for the respective buzzer

⇒ Use the [F1] and [F2] keys to select the desired

- | | |
|-----|--|
| OFF | Deactivate buzzer (no acoustic signal) |
| ON | Activate buzzer (acoustic signal) |

⇒ Press [F4] key to confirm selection.

13.6 Set relay output control



- Optional accessories are required to use this function.
- Information on this can be found on our homepage: www.kern-sohn.com

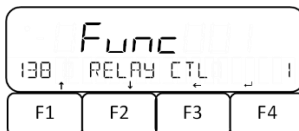

⇒ Use [F1] and [F2] keys to navigate to <138 RELAY CTL>.

⇒ Press [F4] key to change output settings

⇒ Use the [F1] and [F2] keys to select the desired

- | | |
|---|--------------------------------------|
| 1 | Permanent data output |
| 2 | Data output only on external request |

⇒ Press [F4] key to confirm selection.

13.7 Setting the tolerance values



⇒ Press [MENU] key

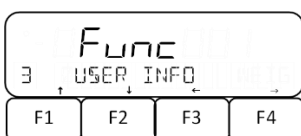

⇒ Use [F1] and [F2] keys to navigate to <3 USER INFO>.

⇒ Press [F4] key to access the settings

- ⇒ Use **[F1]** and **[F2]** keys to set the corresponding parameters for the desired weighing mode.

Take into account the differentiation method (see chapter 13.4): A reference value must be specified when evaluating with differential values

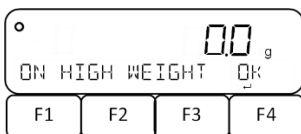
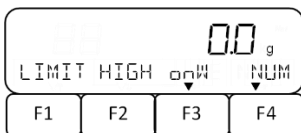
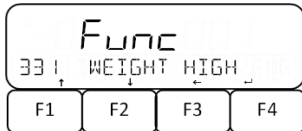
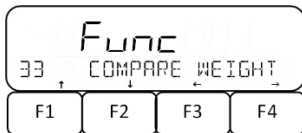

33 COMPARE WEIGHT	Simple weighing
331 WEIGHT HIGH	Upper tolerance limit
332 WEIGHT REF	Reference value
333 WEIGHT LOW	Lower tolerance limit
34 COMPARE PERCENT	Percent weighing
341 PERCENT HIGH	Upper tolerance limit
342 PERCENT REF	Reference value
343 PERCENT LOW	Lower tolerance limit
35 COMPARE COUNT	Piece counting
351 COUNT HIGH	Upper tolerance limit
352 COUNT REF	Reference value
353 COUNT LOW	Lower tolerance limit
36 COMPARE MULT	Coefficient multiplication
361 MULTIPLY HIGH	Upper tolerance limit
362 MULTIPLY REF	Reference value
363 MULTIPLY LOW	Lower tolerance limit

- ⇒ Press **[F4]** key to access the settings

- ⇒ Select the actual value setting method with the **[F3]** key or go to the numerical input of the tolerance value or reference value with the **[F4]** key

onW	Actual value setting method
NUM	Numeric entry

Actual value setting method:

- ⇒ Press **[F3]** key to select **<onW>**.
- ⇒ Place the reference weight on the weighing plate
- ⇒ Press **[F4]** key to save tolerance value or reference value.

Numerical input of the tolerance value:

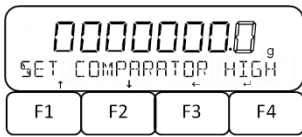

- ⇒ Press **[F4]** key to select **<NUM>**.
- ⇒ Enter value (Numeric entry: see chapter 9.8)
- ⇒ Press **[F4]** key to save tolerance value or reference value.

- ⇒ Press **[MENU]** key to return to measuring mode

14 Totalizing

The **Totalizing** application allows you to weigh different samples and totalize the weight values. This function can be used for various applications, such as weighing individual batches to determine total stock.



Totalizing is available for the following applications: Weighing, percent weighing, piece counting and coefficient multiplication.

Totalizing can be done in two ways:

- Totalizing individual weight values by replacing the sample on the weighing plate: TOTAL-Adding (see chapter 14.3.1)
- Totalizing of single weight values without exchanging the sample on the weighing plate (balance tares automatically after totalizing): NET-Adding (see chapter 14.3.2).

The following steps are needed to use the totalizing function:

1. Select function (see chapter 14.1)
2. Set totalizing method (see chapter 14.2).

14.1 Select the Totalizing function

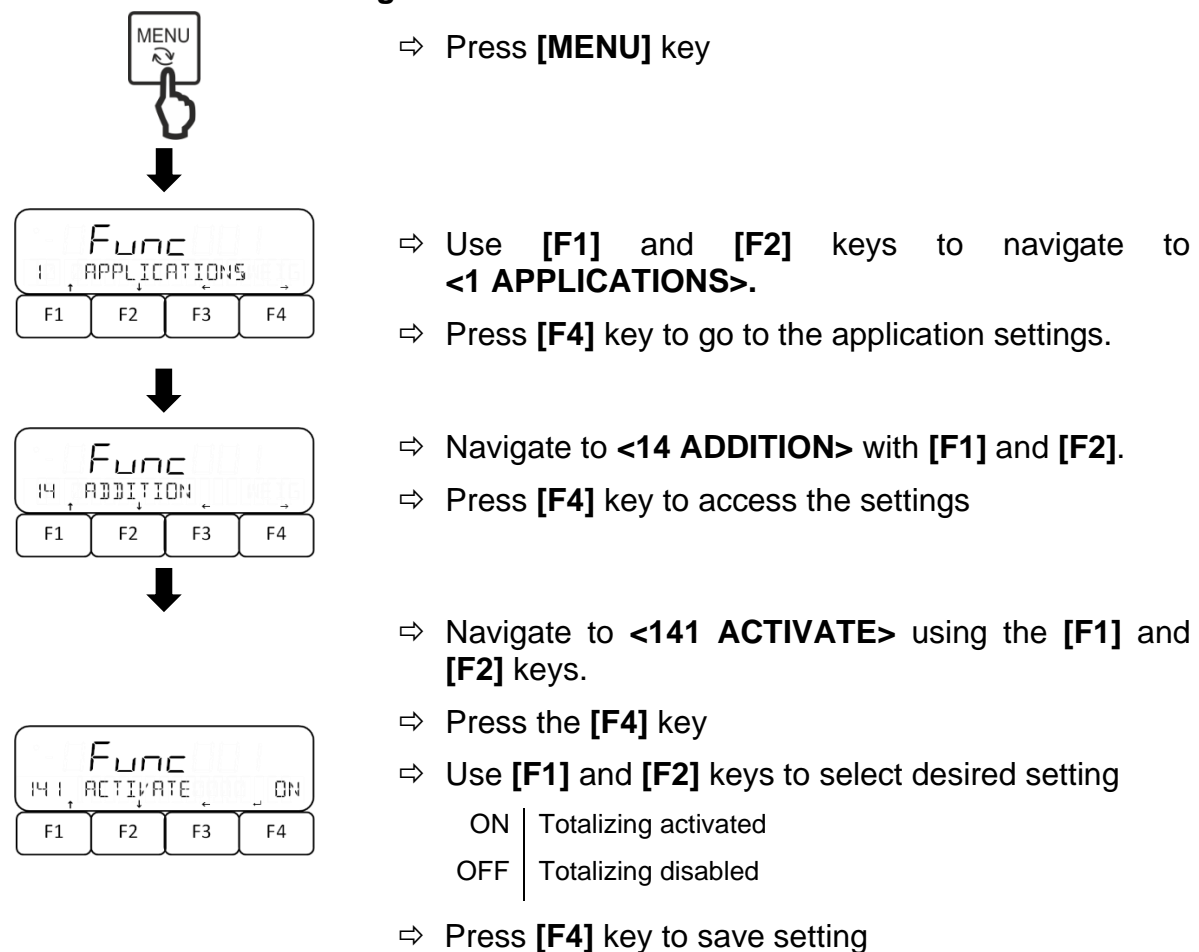

14.2 Set totalizing method

- ⇒ Navigate to **<142 OPERATION>** using the **[F1]** and **[F2]** keys.
- ⇒ Press the **[F4]** key
- ⇒ Use **[F1]** and **[F2]** keys to select desired setting

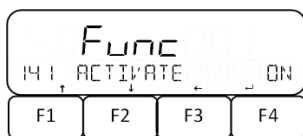

TOTAL	TOTAL-Adding: Totalizing individual weight values by replacing the sample on the weighing plate
NET	NET-Adding: Totalizing individual weight values without replacing the samples on the weighing plate (balance tares automatically after totalizing)

- ⇒ Press **[F4]** key to save setting



- ⇒ Press **[MENU]** key to return to the weighing mode

14.3 Using the totalizing function



The totalizing function for simple weighing must first be assigned to a function key. See Chapter 16.2. for more information on assigning function keys.

14.3.1 TOTAL-Adding

Totalizing weight values:

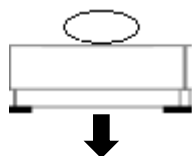

- ⇒ Set balance to **<TOTAL>** (see chapter 14.2).
- ⇒ Place the first sample on the weighing plate and wait until the display shows an asterisk **<*>**.
- ⇒ Press function key which has been assigned with the totalizing function **<ADD>** (In this example: **[F1]** key)

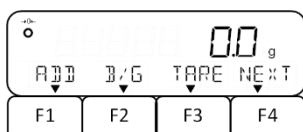
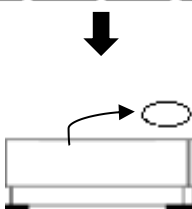

- ⇒ Wait until the totalizing process is completed and the measuring mode is displayed again.
- ⇒ Remove sample from weighing plate (balance performs automatic zeroing)
- ⇒ Place new sample on weighing plate and repeat steps

14.3.2 NET-Adding

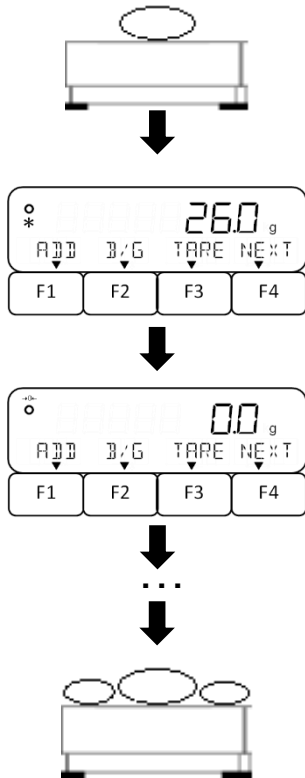

- ⇒ Set balance to **<NET>** (see chapter 14.2)
- ⇒ Place the first sample on the weighing plate and wait until the display shows an asterisk **<*>**.
- ⇒ Press function key which has been assigned with the totalizing function **<ADD>** (In this example: **[F1]** key)
- ⇒ Wait until the totalizing process has been completed and the measuring mode is displayed again (balance performs automatic taring)
- ⇒ Place next sample on the weighing plate and repeat steps

14.3.3 Display or clear the total sum:

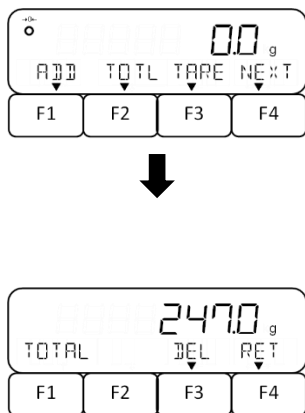

- ⇒ Press the function key that has been assigned with the total sum function **<TOTL>** (in this example: **[F2]** key)
- ⇒ Total sum is displayed (In this example: Weight in g)
- ⇒ Press **[F3]** or **[F4]** key.

DEL	Clear total (scale automatically returns to measuring mode)
RET	Return to measuring mode

15 PRE-TARE

If the tare weight is already known, it can be subtracted from the weight value of the material to be weighed in advance. Up to five tare values can be stored on the scale.



If the scale is switched off, the PRE-TARE mode is deactivated the next time the scale is started.

The tare value can be registered in two different ways:

- Actual value setting method: Weighing the reference weight
- Numerical input of the tare value

15.1 Storing PRE-TARE values

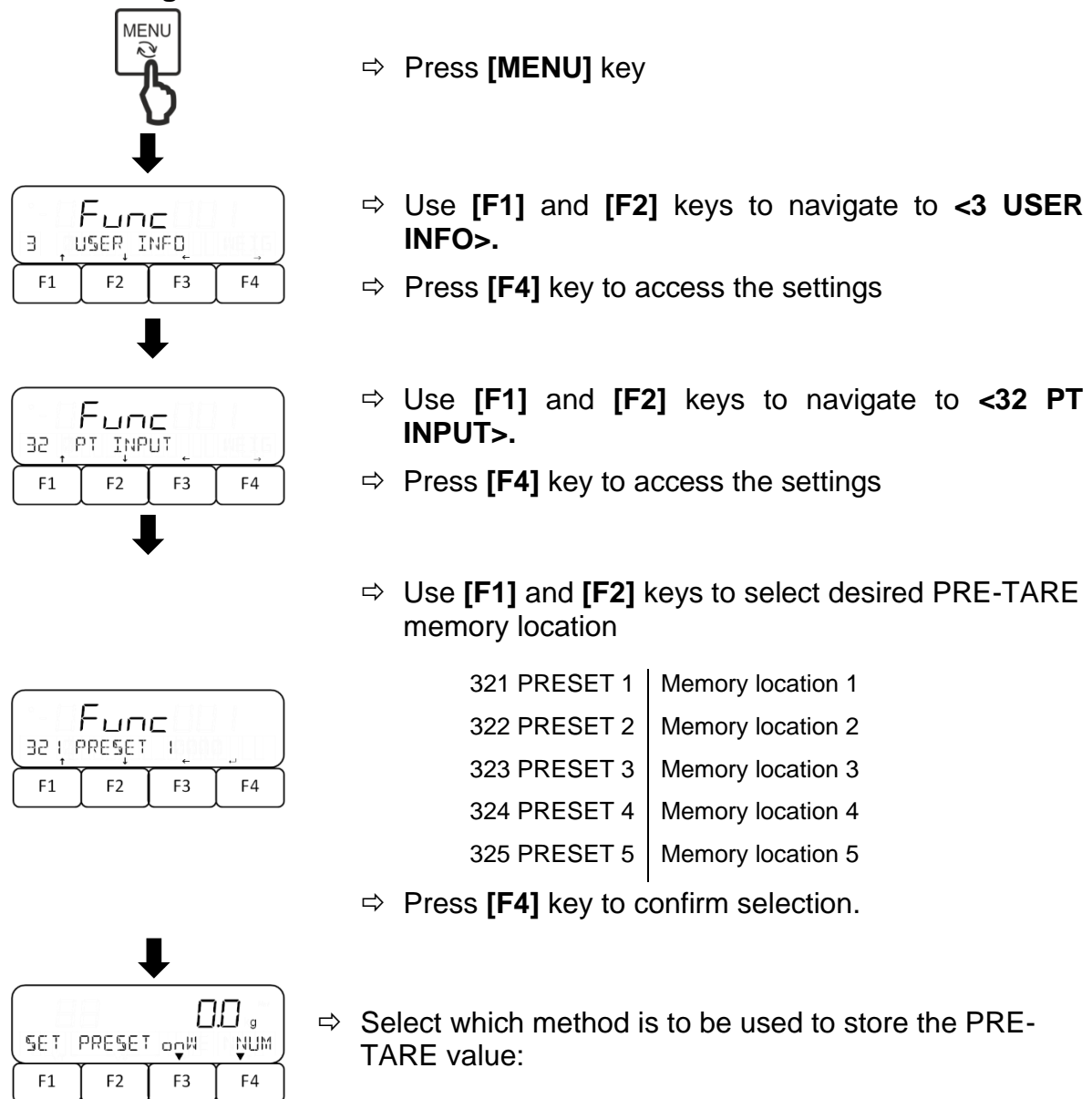

Actual value setting method:

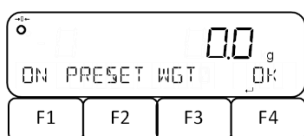

- ⇒ Press **[F3]** key to select **<onW>**.
- ⇒ Place the reference weight on the weighing plate
- ⇒ Press **[F4]** key to save PRE-TARE value.

Numerical input of the PRE-TARE value:

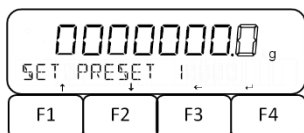

- ⇒ Press **[F4]** key to select **<NUM>**.
- ⇒ Enter value (Numeric entry: see chapter 9.8)
- ⇒ Press **[F4]** key to save PRE-TARE value.



- ⇒ Press **[MENU]** key to return to measuring mode

15.2 Activate and deactivate stored PRE-TARE values.



- ⇒ Press **[MENU]** key

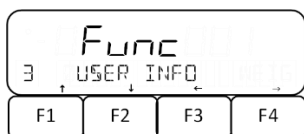

- ⇒ Use **[F1]** and **[F2]** keys to navigate to **<3 USER INFO>**.
- ⇒ Press **[F4]** key to access the settings



- ⇒ Use **[F1]** and **[F2]** keys to navigate to **<31 PT MODE>**.
- ⇒ Press **[F4]** key to enter setting
- ⇒ Mode is located at the bottom right of the display and starts flashing
- ⇒ Use **[F1]** and **[F2]** keys to select desired memory location

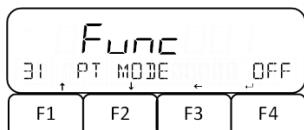

OFF	Disabled
1	Recall memory value 1
2	Recall memory value 2
3	Recall memory value 3
4	Recall memory value 4
5	Recall memory value 5

- ⇒ Press **[F4]** key to confirm selection.
- ⇒ Press **[MENU]** key to return to measuring mode

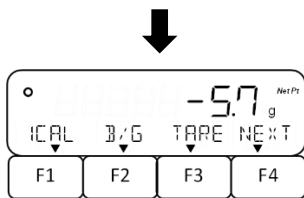

⇒ PRE-TARE value is displayed together with **<Net Pt>** symbol

15.3 Exit PRE-TARE mode

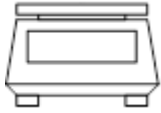

⇒ Unload weighing plate



⇒ Press **[ZERO]** key



⇒ Scale performs zeroing



⇒ The **<Net Pt>** symbol disappears, and the display shows the value **<0.0 g>** and the zero display **<→0←>**.

16 Settings for operation and operating behavior

Settings on the balance can be made via the menu by pressing the **[MENU]** key.



For navigation in the menu see chapter 8.2

16.1 Setting the short commands for weighing applications

Different weighing applications can be assigned to the function keys **[F1]** to **[F3]** as short commands.



The **FEJ** weighing system supports only simple weighing, piece counting and percent weighing. The weighing application coefficient multiplication is not supported.

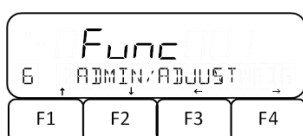

⇒ Use the **[F1]** and **[F2]** keys to navigate to **<6 ADMIN/ADJUST>**.

⇒ Press **[F4]** key to access the settings

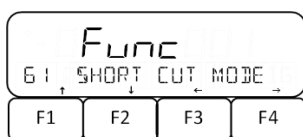

⇒ Use **[F1]** and **[F2]** keys to navigate to **<61 SHORT CUT MODE>**.

⇒ Press **[F4]** key to access the settings



⇒ Use **[F1]** and **[F2]** keys to select desired function key

611 F1 KEY | **[F1]** key

612 F2 KEY | **[F2]** key

613 F3 KEY | **[F3]** key

⇒ Press **[F4]** key to change assigned weighing application

⇒ Weighing application is located at the bottom right of the display and starts flashing

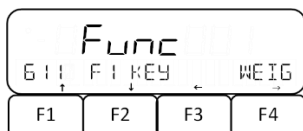

⇒ Use **[F1]** and **[F2]** keys to select desired weighing application.

WEIG | Simple weighing

COUN | Piece counting

PCNT | Percent weighing

MULT | Coefficient multiplication

⇒ Press **[F4]** key to confirm selection.

16.2 Assigning the function keys

Up to six functions can be assigned to the function keys. Three functions are displayed per display page.



- Assignment of functions to keys [F1] to [F3] is only possible for the weighing application of simple weighing
- The <ICAL>, <GLPH>, <GLPF> functions are available only for the FEJ weighing system.
- The <READ> function is not supported by the FES 62K-4D and FEJ 62K-4DM weighing systems.
- The <CAL> and <HOLD> functions are only available on the FES weighing system.
- The functions are shown on several display pages (see chapter 9.7)

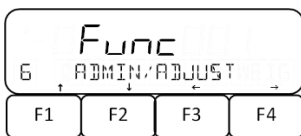

⇒ Use the [F1] and [F2] keys to navigate to <6 ADMIN/ADJUST>.

⇒ Press [F4] key to access the settings



⇒ Use [F1] and [F2] keys to navigate to <62 FREE KEY>.

⇒ Press [F4] key to access the settings



⇒ Use [F1] and [F2] keys to select desired function key

621 F1 KEY	Function 1: [F1] key (display page 1)
622 F2 KEY	Function 2: [F2] key (display page 1)
623 F3 KEY	Function 3: [F3] key (display page 1)
624 F4 KEY	Function 4: [F1] key (display page 2)
625 F5 KEY	Function 5: [F2] key (display page 2)
626 F6 KEY	Function 6: [F3] key (display page 2)

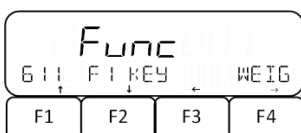

⇒ Press [F4] key to change assigned function

⇒ Function is located at the bottom right of the display and starts flashing

⇒ Use [F1] and [F2] keys to select desired function

NONE	No function
ICAL	Adjustment with internal weight
CAL	Adjustment with external weight
ADD	Totalization
TOTL	Display total sum
HOLD	Stop / freeze measurement display
GLPH	Output GLP header

GLPF	Output GLP footer
RESP	Set reaction speed
B/G	Display gross weight value
DATE	Display date
TIME	Display time
TARE	Display tare value
HIGH	Display upper tolerance limit
LOW	Display lower tolerance limit
ID	Display balance identification number
g	Set weighing unit "Gramm"
kg	Set weighing unit "Kilogramm"
ct	Set weighing unit "Carat"

⇒ Press **[F4]** key to confirm selection.

16.3 Stabilisation waiting time

You can set the scale to display the weight value even if the weight value is not yet stable after zeroing or taring.



- This function is only available for the **FES** weighing system.
- The **FEJ** weighing system always waits for a stable value.

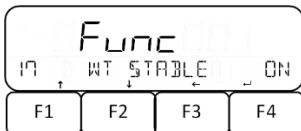

⇒ Use the function keys **[F1]** to **[F4]** to navigate to **<17 WT STABLE>**.

⇒ Press **[F4]** key to make settings

⇒ Select the desired setting with **[F1]** and **[F2]**.

OFF	Disabled
ON	Enabled

⇒ Press **[F4]** key to confirm selection.

16.4 Bar graph display

The scale's bar graph display shows how much the weighing plate is loaded with respect to its weighing range. The bar graph display is used to show the progress of the process during internal adjustment.

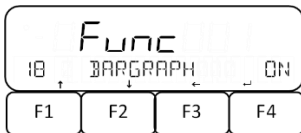
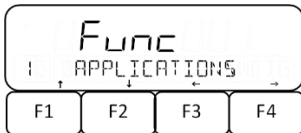

⇒ Use **[F1]** and **[F2]** keys to navigate to **<1 APPLICATIONS>**.

⇒ Press **[F4]** key to go to the application settings.

⇒ Navigate to **<18 BARGRAPH>** using the **[F1]** to **[F4]** keys.

⇒ Press the **[F4]** key

⇒ Use **[F1]** and **[F2]** keys to select desired setting

OFF		Disabled
ON		Show bar graph

⇒ Press **[F4]** key to confirm selection.

16.5 Acoustic signal

The acoustic signal supplements the display on the scales and can support you in your work.

On the scales you can set an acoustic signal to sound in the following cases:

- Piece weight has been updated in the Simple SCS function
- Weight value has been added
- Error message appears
- Low battery charge (for scales with batteries)
- Weight value has been evaluated in the tolerance range during weighing

Setting the acoustic signal in the menu:

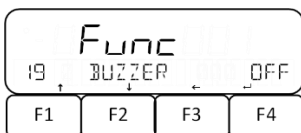
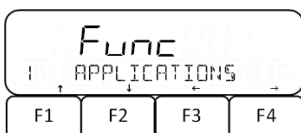

⇒ Use **[F1]** and **[F2]** keys to navigate to **<1 APPLICATIONS>**.

⇒ Press **[F4]** key to go to the application settings.

⇒ Use **[F1]** to **[F4]** keys to navigate to **<19 BUZZER>**.

⇒ Press the **[F4]** key

⇒ Use **[F1]** and **[F2]** keys to select desired setting

OFF		Disabled
MODE 1		Acoustic signal activated

⇒ Press **[F4]** key to confirm selection.

16.6 Background lighting

The backlight makes the display easier to read.



In the following cases, the backlight is not switched off:

- The scale menu is open
- The material to be weighed is on the weighing plate and the weight value is unstable

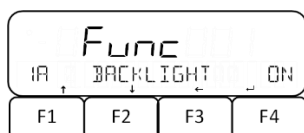
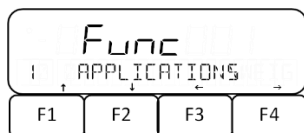

⇒ Use **[F1]** and **[F2]** keys to navigate to **<1 APPLICATIONS>**.

⇒ Press **[F4]** key to go to the application settings.

⇒ Navigate to **<1A BACKLIGHT>** with the keys **[F1]** to **[F4]**

⇒ Press **[F4]** key to make settings

⇒ Select the desired setting with **[F1]** and **[F2]**.

OFF	Disabled
3MIN	Switching off the backlight after 3 min
5MIN	Switching off the backlight after 5 min
10MIN	Switching off the backlight after 10 min
30MIN	Switching off the backlight after 30 min
ON	Backlight always activated

⇒ Press **[F4]** key to confirm selection.

16.7 Stability settings

The stability settings influence the evaluation of weight fluctuations on the weighing plate and to what extent the weight value is displayed as a stable value.

As a rule: **The greater the value set, the greater the weight fluctuations can be for the weight value to be displayed as stable.**



- Full functionality is only available for the **FES** weighing system.
- Settings 2 and 4 are not available for the **FEJ** weighing system.

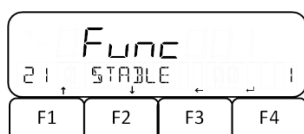
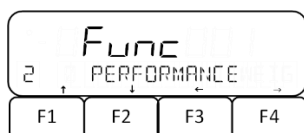

⇒ Navigate to **<2 PERFORMANCE>** using the **[F1]** and **[F2]** keys.

⇒ Press **[F4]** key to access the settings

⇒ Use **[F1]** to **[F4]** keys to navigate to **<21 STABLE>**.

⇒ Press **[F4]** key to make settings

⇒ Select the desired setting with **[F1]** and **[F2]**

0.5	0.5d
1	1.0d
2	2.0d
4	4.0d

⇒ Press **[F4]** key to confirm selection.

16.8 Reaction settings

The reaction settings allow you to adjust the scale to the environmental conditions. The reaction settings influence the stability display of the balance.

The following applies: **The higher the value set, the less sensitive the scale is to environmental influences (e.g. wind or vibration) and is more likely to display a stable weight value.**

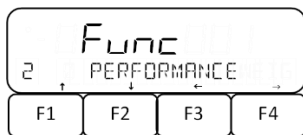

⇒ Navigate to **<2 PERFORMANCE>** using the **[F1]** and **[F2]** keys.

⇒ Press **[F4]** key to access the settings

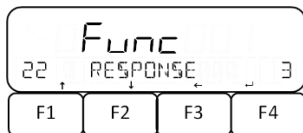

⇒ Use the **[F1]** to **[F4]** keys to navigate to **<22 RESPONSE>**.

⇒ Press **[F4]** key to make settings

⇒ Select the desired setting with **[F1]** and **[F2]**.

1	Very strong sensitivity
2	Strong sensitivity
3	Normal
4	Weak sensitivity
5	Very weak sensitivity (anti-vibration)

⇒ Press **[F4]** key to confirm selection.

16.9 Zero-Tracking

Small weight variations (e.g. due to particles on the weighing plate) can be automatically tared by zero tracking.



Settings 1, 2 and 4 are not available for the **FEJ** weighing system.

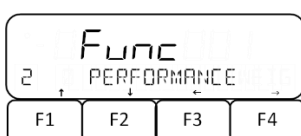

⇒ Navigate to **<2 PERFORMANCE>** using the **[F1]** and **[F2]** keys.

⇒ Press **[F4]** key to access the settings



- ⇒ Navigate to **<23 ZERO TRAC>** using the **[F1]** to **[F4]** keys.
- ⇒ Press **[F4]** key to make settings
- ⇒ Select the desired setting with **[F1]** and **[F2]**.

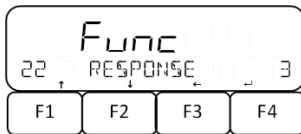

OFF	Disabled
0.5	0.5d
1	1d
2	2d
4	4d

- ⇒ Press **[F4]** key to confirm selection.

16.10 Simple SCS (Self Counting System)

Simple SCS allows you to count pieces even more accurately. If Simple SCS has been enabled, the average piece weight is automatically adjusted if another reference sample is placed on the weighing plate when weighing the reference piece count.

16.10.1 Enabling / disabling Simple SCS

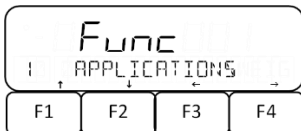

- ⇒ Use **[F1]** and **[F2]** keys to navigate to **<1 APPLICATIONS>**.
- ⇒ Press **[F4]** key to access the settings

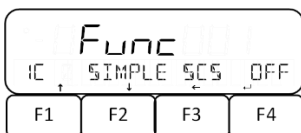

- ⇒ Navigate to **<1C SIMPLE SCS>** with keys **[F1]** to **[F4]**
- ⇒ Press **[F4]** key to make settings
- ⇒ Select the desired setting with **[F1]** and **[F2]**

OFF	Disabled
ON	Enabled

- ⇒ Press **[F4]** key to confirm selection.

16.10.2 Using Simple SCS

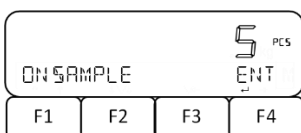

- ⇒ In piece counting mode, select the actual value setting method and select the reference piece count (see chapter).
- ⇒ When **<ON SAMPLE>** flashes, apply the reference piece quantity according to chapter and confirm by pressing **[F4]**.

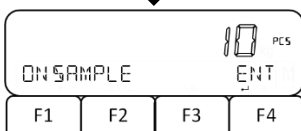

- ⇒ Reference piece quantity on the display starts flashing
- ⇒ Place more reference pieces (the number of pieces

must not be more than twice as large as the initially selected reference number of pieces → Example Selected = 10 pieces, additional reference pieces = 20 pieces or less)

⇒ Press the [F4] key to save the reference weight.

When the scale shows <Add> or <Sub>:



- If the sample weight is less than 90 times the readability (90 x d), the display shows <Add> and the unit weight cannot be updated. In this case, place as many pieces on the weighing plate until the message is no longer displayed or select a higher reference piece count (see chapter 10.2).
- If the additional reference piece count is more than twice the initial reference piece count, the display will show <Sub> and the piece weight cannot be updated. In this case, reduce the number of pieces of the additionally placed sample.

16.11 Multi-range mode

The models FEJ 62K-4D and FEJ 62K-4DM are set as multi-range scales 6.2 kg = 0.1 g and 62 kg= 1 g readability as standard. The scales can also be set as single-range scales with a readability of 1 g.



This function is only available for the weighing systems **FES 62K-4D** and **FEJ 62K-4DM**

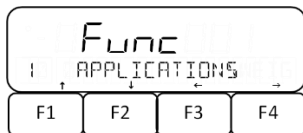

⇒ Use [F1] and [F2] keys to navigate to <1 APPLICATIONS>.

⇒ Press [F4] key to go to the application settings.

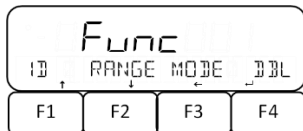

⇒ Navigate to <1D RANGE MODE> with the keys [F1] to [F4]

⇒ Press [F4] key to make settings

⇒ Select the desired setting with [F1] and [F2].

SGL		Single-range mode
DBL		Multi-range mode

⇒ Press [F4] key to confirm selection.

16.12 Automatic switch-off function

If the automatic switch-off function is activated, the scale switches off automatically if it is no longer used within a set period of time.



The scale does not switch off automatically,

- when the menu of the scale is open
- when there is material to be weighed on the weighing plate and the value is unstable.

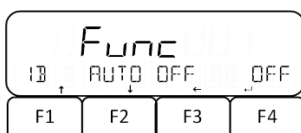
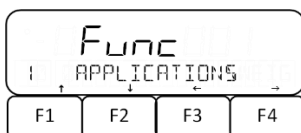

⇒ Use **[F1]** and **[F2]** keys to navigate to **<1 APPLICATIONS>**.

⇒ Press **[F4]** key to go to the application settings.

⇒ Navigate to **<1B AUTO OFF>** with the **[F1]** and **[F2]** keys.

⇒ Press **[F4]** key to make settings

⇒ Select the desired setting on keys **[F1]** and **[F2]**.

OFF	Disabled
3MIN	Switch off after 3 min
5MIN	Switch off after 5 min
10MIN	Switch off after 10 min
30MIN	Switch off after 30 min

⇒ Press **[F4]** key to confirm selection.

17 User administration and access rights

The scale has a user administration function that can be used to define individual access rights for users at administrator level. User management requires the entry of an administrator password.

The administrator can use all the functions and has all rights. Only an admin can manage the users and grant access rights. A user on the other hand may not have access to all functions. Admins have limited rights, which are set in administrator mode.

The maximum of users is limited to 2. The scale has a guest access. No password can be assigned to this access.

Settings on the balance can be made via the menu by pressing the **[MENU]** key.



- For navigation in the menu see chapter 8.2
- Keep your passwords in a safe place
- Contact the manufacturer if you lose the administrator password.

17.1 User administration

User administration settings are always made in the **<64 SCALE MANAGE>** menu.

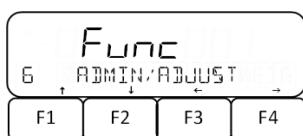

⇒ Use the **[F1]** and **[F2]** keys to navigate to **<6 ADMIN/ADJUST>**.

⇒ Press **[F4]** key to access the settings

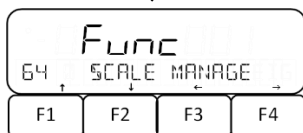

⇒ Navigate to **<64 SCALE MANAGE>** with the **[F1]** and **[F2]** keys.

⇒ Press **[F4]** key to access the settings

17.1.1 Activate / deactivate password control



Password control does not work until the scale is restarted.

⇒ Open **<64 SCALE MANAGE>** (see chapter 17.1).

⇒ Navigate to **<642 PASSWORD>** with the **[F1]** and **[F2]** keys.

⇒ Press **[F4]** key to make settings

⇒ Select the desired setting with **[F1]** and **[F2]**.

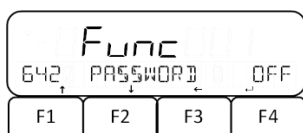

OFF | Password control disabled

ON | Password control enabled

⇒ Press **[F4]** key to confirm selection.

17.1.2 Assign passwords



- Only one administrator can be stored on the scale.
- To set users, the scale must be in administrator mode (log in to the scale: see chapter 17.2)
- **<644 SET USER PASS>** is only available in administrator mode.
- Up to two users can be set on the scale.
- User passwords are assigned for the user number selected at the administrator login (see chapter 17.2)
- The password consists of four digits (0 to 9)
- No password can be assigned for guest access

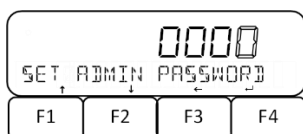
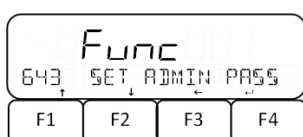

- ⇒ Open **<64 SCALE MANAGE>** (see chapter 17.1).
- ⇒ Navigate to **<643 SET ADMIN PASS>** or **<644 SET USER PASS>** using the **[F1]** and **[F2]** keys.

643 SET ADMIN PASS	Password for administrator
644 SET USER PASS	Password for user
- ⇒ Press the **[F4]** key to enter the password.

- ⇒ Enter password (Numeric entry: See chapter 9.7)
- ⇒ Press the **[F4]** key to save the password.

17.2 Logging a user on to the scale



To log in a user, the password control must be activated (see chapter 17.1.1)

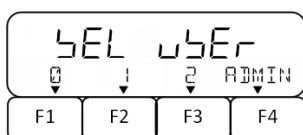

- ⇒ Switch on balance
- ⇒ Login prompt for the user appears on the display
- ⇒ Select user mode **<USER>** or administrator mode **<ADMIN>**.

Select user mode:

- ⇒ The scale starts by selecting a user
- ⇒ Select the number of the desired user with the **[F1]** to **[F3]** keys.

0	Guest
1	User 1
2	User 2

Select administrator mode:

- ⇒ Press **[F4]** key to select **<ADMIN>**.
- ⇒ Select the number of the user for whom settings need to be made using the **[F1]** to **[F3]** keys.

0	Make settings for guest
1	Make settings for user 1
2	Make settings for user 2

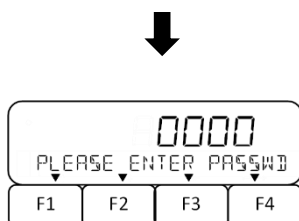

- ⇒ Enter the password using the **[F1]** to **[F4]** keys.
(key number = digit position; digit is always incremented by 1).

If <0> (guest) is selected in user mode, the password entry is omitted and the scale automatically switches to measurement mode.

- ⇒ Press **[ZERO]** key to confirm password and log in user or administrator

17.3 Managing access rights

In the access rights management, the administrator can define which keys or setting menus the users can access.



⇒ Only the administrator can access the **<5 LOCK>** and **<6 ADMIN/ADJUST>** menu items.

17.3.1 Lock keys

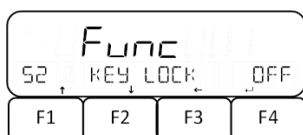

- ⇒ Navigate to **<52 KEY LOCK>** with the **[F1]** and **[F2]** keys.

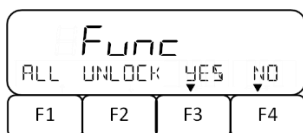

- ⇒ Press **[F4]** key to make settings
- ⇒ Select the desired setting with **[F1]** and **[F2]**.

OFF	No restrictions
1	[ON/OFF] key locked Measurement mode: All keys locked except [MENU]
2	[ON/OFF] key locked

- ⇒ Press **[F4]** key to confirm selection.

17.3.2 Lock menu

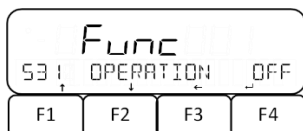
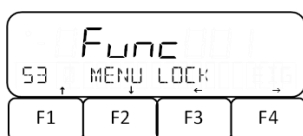

⇒ Use **[F1]** and **[F2]** keys to navigate to **<53 MENU LOCK>**.

⇒ Press **[F4]** key to make settings

⇒ Use **[F1]** and **[F2]** to select the desired settings menu for which you want to set the access rights (Menu overview: see chapter 8.1)

531 OPERATION		<1 APPLICATIONS>
532 PERFORM		<2 PERFORMANCE>
533 USER		<3 USER INFO>
534 I/O		<4 EXTERNAL I/O>

⇒ Press **[F4]** key to make settings

⇒ Select the desired setting with **[F1]** and **[F2]**.

OFF		Settings menu not locked
ON		Settings menu locked

- Press **[F4]** key to confirm selection.

17.3.3 Unlock all access locks

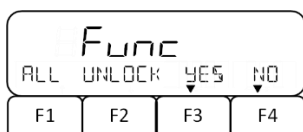
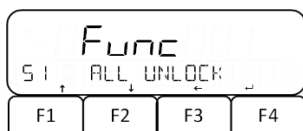

⇒ Navigate to **<51 ALL UNLOCK>** using the **[F1]** and **[F2]** keys.

⇒ Press **[F4]** key to make settings

⇒ Select the desired setting with **[F3]** and **[F4]**.

YES		Unlock all locks
NO		Do not unlock

17.4 Set short commands and functions for users

Shortcuts for weighing applications (see chapter 16.1) and allocation of function keys (see chapter 16.2) can be assigned individually for each user. To change these settings, password control must be activated on the scale (see chapter 17.1.1) and the scale must be in administrator mode (see chapter 17.2).

18 System Settings

Settings on the balance can be made via the menu by pressing the **[MENU]** key.



For navigation in the menu see chapter 8.2

18.1 Call System Settings

The system settings described in this chapter are always made in the **<64 SCALE MANAGE>** menu.

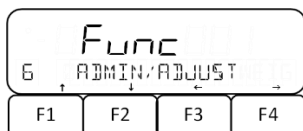

⇒ Use the **[F1]** and **[F2]** keys to navigate to **<6 ADMIN/ADJUST>**.

⇒ Press **[F4]** key to access the settings

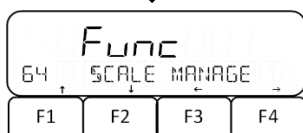

⇒ Navigate to **<64 SCALE MANAGE>** with the **[F1]** and **[F2]** keys.

⇒ Press **[F4]** key to access the settings

18.2 Balance identification number

Your scale can be distinguished from other scales by assigning a scale identification number. The scale identification number is shown on the adjustment record. The scale identification number can be displayed by pressing the function key to which this function has been assigned.



A maximum of 10 digits can be assigned to the scale identification number.

Set the scale identification number:

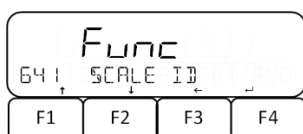

⇒ Open **<64 SCALE MANAGE>** (see chapter 18.1).

⇒ Navigate to **<641 SCALE ID>** using the **[F1]** to **[F4]** keys.

⇒ Press **[F4]** key to make settings

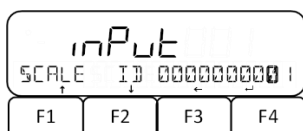

⇒ The digit to be entered flashes

⇒ Enter desired number (Numeric entry: see chapter 9.8)

⇒ Press **[F4]** key to confirm entry.

18.3 Date display format

The scale allows you to set the format in which the date is displayed.

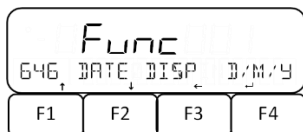

- ⇒ Open **<64 SCALE MANAGE>** (see chapter 18.1).
- ⇒ Use the **[F1]** and **[F2]** keys to navigate to **<646 DATE DISP.>**.
- ⇒ Press **[F4]** key to make settings
- ⇒ Use **[F1]** and **[F2]** to select the desired setting:

Y/M/D	Year, Month, Day
D/M/Y	Day/Month/Year
M/D/Y	Month/Day/Year
- ⇒ Press **[F4]** key to confirm selection.

18.4 Date and time

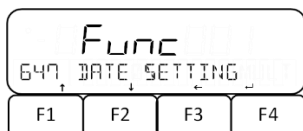

- ⇒ Open **<64 SCALE MANAGE>** (see chapter 18.1).
- ⇒ Navigate to **<647 DATE SETTING>** or **<648 TIME SETTING>** using the keys **[F1]** and **[F2]**.

647 DATE SETTING	Setting date
648 TIME SETTING	Setting time
- ⇒ Press **[F4]** key to make settings

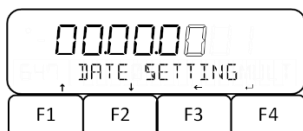

- ⇒ The digit to be entered flashes
- ⇒ Enter date or time (Numeric entry: see chapter 9.7)
- ⇒ Press **[F4]** key to confirm entry.

18.5 Output language

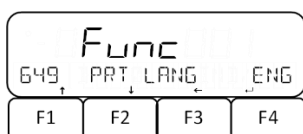

- ⇒ Open **<64 SCALE MANAGE>** (see chapter 18.1).
- ⇒ Navigate to **<649 PRT LANG>** using the keys **[F1]** and **[F2]**.
- ⇒ Press **[F4]** key to make settings
- ⇒ Use key **[F1]** and **[F2]** to select the desired setting:

ENG	English
JPN	Japanese
- ⇒ Press **[F4]** key to confirm selection.

18.6 Readability

The greater the readability is set, the less the scale is affected by external influences. In addition, the weight value stabilises more quickly.



- This function is not available for the **FES 62K-4D** and **FEJ 62K-4DM** weighing systems.
- This menu is blocked for the **FEJ 17K-4M** and **FEJ 33K-4M** weighing systems

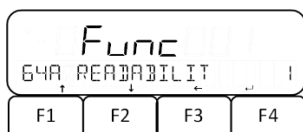

- ⇒ Open **<64 SCALE MANAGE>** (see chapter 18.1).
- ⇒ Navigate to **<64A READABILIT>** with the **[F1]** and **[F2]** keys.
- ⇒ Press **[F4]** key to make settings
- ⇒ Use **[F1]** and **[F2]** to select the desired setting:

1		1 (default)
2		2
5		5
10		10

- ⇒ Press **[F4]** key to confirm selection.

18.7 Adjustment with internal weight at power-up



This function is only available for the **FEJ** weighing system.

18.7.1 Activate internal adjustment at power-up

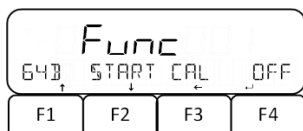

- ⇒ Open **<64 SCALE MANAGE>** (see chapter 18.1).
- ⇒ Use **[F1]** and **[F2]** to navigate to **<64B START CAL>**.
- ⇒ Press **[F4]** key to make settings
- ⇒ Use **[F1]** and **[F2]** to select the desired setting:

OFF		Disabled
FORCE		Always adjust the scale at power-up
SELEC		Ask if adjustment needs to be performed each time the scale is switched on

- ⇒ Press **[F4]** key to confirm selection.

18.7.2 Perform internal adjustment



The balance must not be switched off, disconnected from the power supply or loaded during internal adjustment

⇒ Switch on balance

If internal adjustment is activated every time the balance is switched on:

⇒ The scales perform the internal adjustment and automatically switch to measuring mode.

If internal adjustment is activated on request:



⇒ Select the desired setting with **[F3]** and **[F4]**.

YES | Perform internal adjustment

NO | Do not perform internal adjustment

⇒ The scales perform the internal adjustment and automatically switch to measuring mode.

18.8 Output of the adjustment test result

The scale provides the option to automatically show the result on the interface after adjustment or after the adjustment test.



To use this function, you must activate **<41 RS232 C>** (see chapter 21.7.1).

⇒ Open **<64 SCALE MANAGE>** (see chapter 18.1).

⇒ Use the **[F1]** and **[F2]** keys to navigate to **<645 SPAN OUT>**.

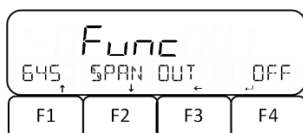

⇒ Press **[F4]** key to make settings

⇒ Use keys **[F1]** and **[F2]** to select the desired setting:

OFF | Disabled

ON | Enabled

⇒ Press **[F4]** key to confirm selection.

18.9 Automatic power on when connected to mains

If the automatic power-on function is enabled, the scale will switch on automatically when it is connected to the mains. Users then no longer need to press the **[ON/OFF]** key. This function can be used, for example, when the scale is used in conjunction with other equipment.

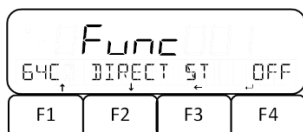

- ⇒ Open **<64 SCALE MANAGE>** (see chapter 18.1).
- ⇒ Navigate to **<64C DIRECT ST>** with the **[F1]** and **[F2]** keys.
- ⇒ Press **[F4]** key to make settings
- ⇒ Select the desired setting with **[F1]** and **[F2]**.

OFF	Disabled
ON	Enabled
- ⇒ Press **[F4]** key to confirm selection.

18.10 Restore last tare value

The scale provides the option to restore the last tare value used before the scale was switched off when it is switched on again. If this function is activated, users do not need to tare again in the event of a power failure, for example, if the same tare weight is used.



This function is only available for the **FES** weighing system.



- This function is not suitable for permanently storing PRE-TARE values. Use the PRE-TARE function if you want to use a permanent PRE-TARE value (see chapter 15)
- If adjustment with internal weight has been activated at switch-on (see chapter 18.7), the weighing plate must be unloaded before switching on.
- If the weighing plate is permanently loaded over a longer period of time, this can lead to incorrect weighing results.



- ⇒ Open **<64 SCALE MANAGE>** (see chapter 18.1).
- ⇒ Use the **[F1]** and **[F2]** keys to navigate to **<64D STORE TARE>**.
- ⇒ Press **[F4]** key to make settings
- ⇒ Select the desired setting on keys **[F1]** and **[F2]**.

OFF	Disabled
ON	Enabled
- ⇒ Press **[F4]** key to confirm selection.

18.11 Restore factory settings

When restoring the factory settings of the scale, all settings except span setting, date and time, are reset.

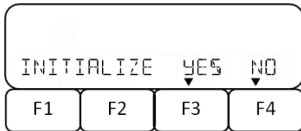
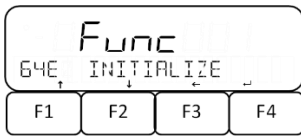

- ⇒ Open **<64 SCALE MANAGE>** (see chapter 18.1).
- ⇒ Navigate to **<64E INITIALIZE>** using the **[F1]** and **[F2]** keys.
- ⇒ Press **[F4]** key to make settings

- ⇒ Select the desired setting on keys **[F3]** and **[F4]**.

YES		Restore factory settings
NO		Cancel

19 Adjustment

As the value of the acceleration due to gravity is not the same at every location on earth, according to the underlying physical weighing principle, each scale must be adjusted to the place of installation to the acceleration due to gravity prevailing there (only if the scale has not already been adjusted to the place of installation at the factory).

This adjustment process must be carried out for the first commissioning, after each change of location as well as in case of fluctuating environment temperature. To receive accurate measuring values it is also recommended to adjust the balance periodically in weighing operation.



- Observe stable environmental conditions. A warm up time (see chapter 1) is required for stabilization.
- Ensure that there are no objects on the weighing pan.
- Avoid vibration and air flow.
- Always carry out adjustment with the standard weighing plate in place.
- To cancel internal adjustment, press the **ON/OFF** key.
- The adjustment record is printed if an optional printer is connected and the GLP function has been activated.



- The **FES** weighing system requires external adjustment weights for adjustment and adjustment.
- The **FEJ** weighing system has an internal adjustment weight.

The settings for adjustment described in this chapter are always changed in menu **<63 MAINTENANCE>**.

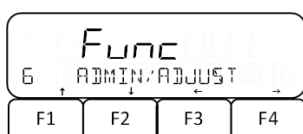

⇒ Use the **[F1]** and **[F2]** keys to navigate to **<6 ADMIN/ADJUST>**.

⇒ Press **[F4]** key to access the settings

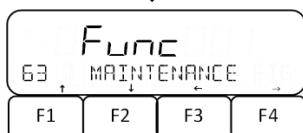

⇒ Navigate to **<63 MAINTENANCE>** using the keys **[F1]** and **[F2]**.

⇒ Press **[F4]** key to access the settings

19.1 Adjustment with external weight



This function is only available for the **FES** weighing system.

19.1.1 Performing the external adjustment

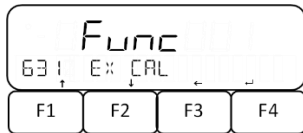

- ⇒ Open **<63 MAINTENANCE>** (see chapter 19).
- ⇒ Navigate to **<631 EX CAL>** using the **[F1]** and **[F2]** keys.
- ⇒ Press **[F4]** to start external adjustment.



For the FES 17K-4 and FES 33K-4 weighing systems (this step is skipped for FES 62K-4D):



- ⇒ Press keys **[F1]** and **[F2]** to select how the external adjustment weight should be rounded.

1	0.1 g
2	0.2 g
5	0.5 g
10	1 g

- ⇒ Press **[F4]** key to confirm selection.

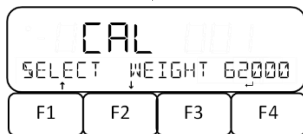

- ⇒ Select the desired adjustment weight on the keys **[F1]** and **[F2]**.
- ⇒ Press **[F4]** key to confirm selection.



- ⇒ The scale performs a zero setting
- ⇒ Various messages are shown on the display one after another: **<buSY>** → **<on 0>** → **<on FS>**
- ⇒ With **<on FS>** the zero setting is completed.

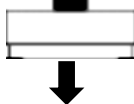

- ⇒ Place the adjustment weight centrally on the weighing plate.

For the weighing system FES 17K-4:



- ⇒ Message **<on FS>** appears on the display and starts flashing
- ⇒ Adjustment starts

For the weighing systems FES 33K-4 and FES 62K4-D:



- ⇒ Various messages are shown on the display one after another: **<on FS>** → **<push M>**



- ⇒ Press **[MENU]** key



- ⇒ Message **<on FS>** appears on the display and starts flashing
- ⇒ Adjustment starts

Completing the adjustment:

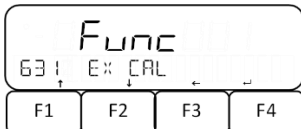

- ⇒ When **<631 EX CAL>** is displayed on the scale, the adjustment is completed.
- ⇒ Unload weighing plate

19.1.2 Adjustment test with external weight

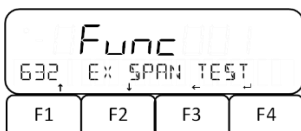

- ⇒ Open **<63 MAINTENANCE>** (see chapter 19).
- ⇒ Navigate to **<632 EX SPAN TEST>** using the **[F1]** and **[F2]** keys.
- ⇒ Press **[F4]** key to start external adjustment test



- ⇒ The scale performs a zero setting
- ⇒ Various messages are shown on the display one after another: **<buSY>** → **<on 0>** → **<on FS>**
- ⇒ With **<on FS>** the zero setting is completed.

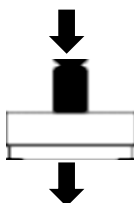

- ⇒ Place the adjustment weight centrally on the weighing plate.

For the weighing system FES 17K-4:



- ⇒ Message **<on FS>** appears on the display and starts flashing
- ⇒ The adjustment test starts

For the weighing systems FES 33K-4 and FES 62K4-D:



- ⇒ Various messages are shown on the display one after another: **<on FS>** → **<push M>**



- ⇒ Press **[MENU]** key



- ⇒ Message **<on FS>** appears on the display and starts flashing
- ⇒ The adjustment test starts

Completing the adjustment test:

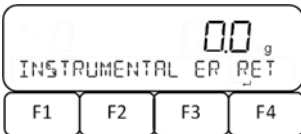

- ⇒ When **<INSTRUMENTAL ER>** is displayed, press **[F4]** key.

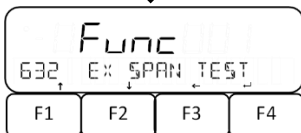

- ⇒ When **<632 EX SPAN TEST>** is displayed again, the external adjustment test is completed.

19.2 Adjustment with internal weight

With the internal adjustment weight, the weighing accuracy can be checked and re-adjusted at any time.



Internal adjustment is only available with the **FEJ** weighing system.



The scale must not be switched off or disconnected from the power supply during internal adjustment or the internal adjustment test

19.2.1 Performing the internal adjustment

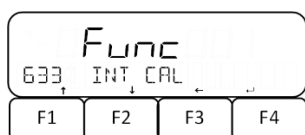

...

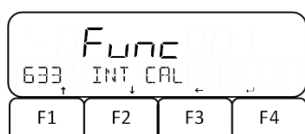

- ⇒ Open **<63 MAINTENANCE>** (see chapter 19).
- ⇒ Use **[F1]** and **[F2]** keys to navigate to **<633 INT CAL>**.
- ⇒ Press **[F4]** key to start internal adjustment.

- ⇒ Various messages are shown on the display one after another: **<buSY>** → **<Ch 0>** → **<Ch FS>**

- ⇒ When **<633 INT CAL>** is displayed again, the internal adjustment is complete.

19.2.2 Adjustment test with internal weight

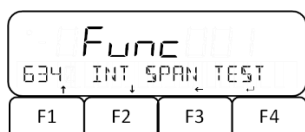
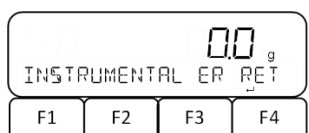
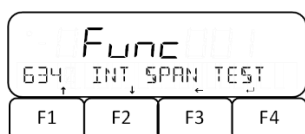

- ⇒ Open **<63 MAINTENANCE>** (see chapter 19).
- ⇒ Use **[F1]** and **[F2]** keys to navigate to **<634 INT SPAN TEST>**.
- ⇒ Press the **[F4]** key to start the internal adjustment test.

- ⇒ Various messages are subsequently shown on the display: **<buSY>** → **<Ch 0>** → **<Ch FS>** → **<INSTRUMENTAL ER>**
- ⇒ Press the **[F4]** key when **<INSTRUMENTAL ER>** is displayed.

- ⇒ When **<634 INT SPAN TEST>** is displayed again, the internal adjustment test is complete.

19.3 Setting the adjustment reminder

The adjustment reminder triggers an alarm when the scale needs a new adjustment. This is the case if the scale has not been switched on for a long time, if the temperature or atmospheric pressure is different, or if the last adjustment was made a long time ago.



This function is only available for the **FES** weighing system.

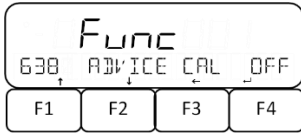

- ⇒ Open **<63 MAINTENANCE>** (see chapter 19).
- ⇒ Navigate to **<638 ADVICE CAL>** with the **[F1]** and **[F2]** keys.
- ⇒ Press **[F4]** key to make settings
- ⇒ Use **[F1]** and **[F2]** to select the desired setting:

OFF	Reminder disabled
NTF	Reminder enabled
- ⇒ Press **[F4]** key to confirm selection.

Reminder when adjustment is required:



- ⇒ When the scale requires a new adjustment, the display will show the message **<PLEASE EXE CAL>**.
- ⇒ Press **[F4]** to close the message.
- ⇒ Carry out adjustment (see chapter 0)

19.4 Position of the adjustment switches and seal marks

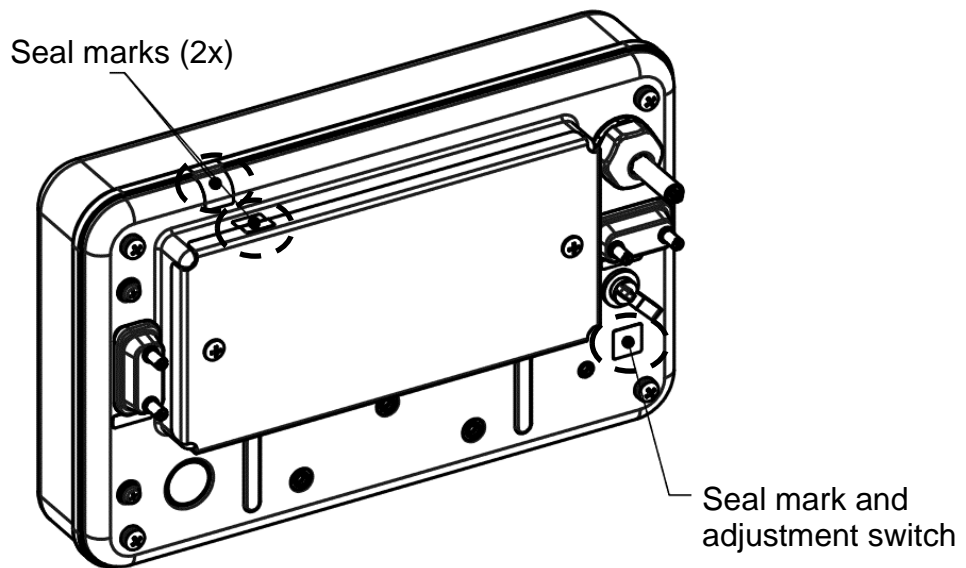

20 Verification

General:

According to EU directive 2014/23/EU balances must be officially verified if they are used as follows (legally controlled area):

- a) For commercial transactions if the price of goods is determined by weighing.
- b) For the production of medicines in pharmacies as well as for analyses in the medical and pharmaceutical laboratory.
- c) For official purposes
- d) For manufacturing final packages

In cases of doubt, please contact your local trade in standard.

Scales in the legally regulated range (→ verified scales) must comply with the error limits during the verification period - these are usually twice the error limits.

When this verification validity period expires, a re-verification must be carried out. If the scale must be adjusted to comply with the verification error limits to pass this re-verification, this does not constitute a case of warranty.

Verification notes:

An EU type approval exists for balances described in their technical data as verifiable. If the balance is used where obligation to verify exists as described above, it must be verified and re-verified at regular intervals.

Re-verification of a balance is carried out according to the respective national regulations. The validity for verification of balances in Germany is normally 2 years.

The legal regulation of the country where the balance is used must be observed!



Verification of the balance is invalid without the seal.

The seal marks attached on verified balances point out that the balance may only be opened and serviced by trained and authorized specialist staff. If the seal mark is destroyed, verification loses its validity. Please observe all national laws and legal regulations. In Germany a re-verification will be necessary.

21 Interfaces

The scale can communicate with external peripheral devices using the interfaces. Data can be sent to a printer, PC or control displays. In the same way, control commands and data inputs may occur via the connected devices (such as PC, keyboard, barcode reader).

The standard equipment includes two RS-232C (D-SUB 9P) interfaces. The first RS-232C [1] is bidirectional and intended for input and output. The second RS-232C [2] is for output only.

The RS-232C and the serial output for peripherals output the same signal. A relay output can be added as a factory option.



21.1 RS-232C interface for data input and output

The scale is equipped as standard with an RS232C port for connecting a peripheral device (e.g. printer or computer).

21.1.1 Technical data

Connection	9 pin D-SUB socket
Baud rate	1200/2400/4800/9600/ 19200/38400/57600/115200 wählbar
Parity	None / Odd number / Even number

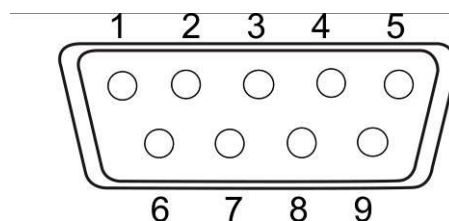

Pin connection:

Pin nr.	Signal	Input/Output	Function
1	-	-	-
2	RXD	Input	Receive data
3	TXD	Output	Edit data
4	DTR	Output	HIGH (when scale is switched on)
5	GND	-	Signal ground
6	-	-	-
7	-	-	-
8	-	-	-
9	EXT. TARE	Input	External contact input for tare subtraction



Tare subtraction can be performed by an external device by connecting a link or a transistor between pin 9 (EXT. TARE) and pin 5 (GND). A switch-on time of at least 400 ms must be observed (Open circuit voltage: 15 V when the scale is switched off, leakage current: 20 mA, when it is switched on).

21.1.2 Interface cable

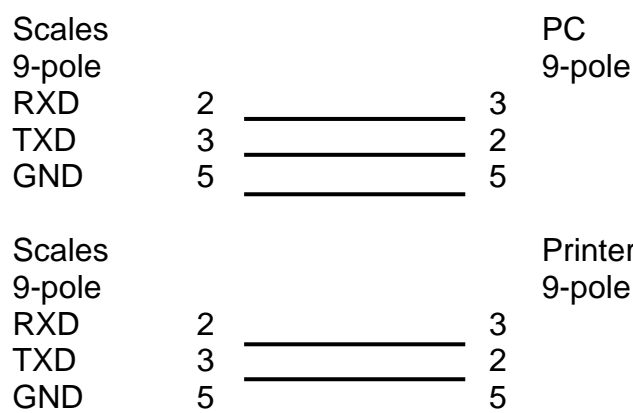

21.2 RS232C interface for data output

Connection 9 pin D-SUB socket
Baud rate 1200/2400/4800/9600/
 19200/38400/57600/115200 selectable
Parity None / Odd number / Even number

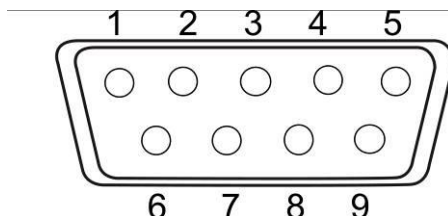

Pin connection:

Pin nr.	Signal	Input/Output	Function
1	-	-	-
2	-	-	-
3	TXD	Output	Edit data
4	DTR	Output	HIGH (when scale is switched on)
5	GND	-	Signal ground
6	-	-	-
7	-	-	-
8	-	-	-
9	-	-	-

21.3 Data Output Formats (CSP)



The CSP data output formats are only available for the **FES** weighing system.

21.3.1 Data composition

Measurement results:

- **6-digit data format**

Consists of 14 characters, including the end characters (CR= 0DH, LF= 0AH)*

1	2	3	4	5	6	7	8	9	10	11	12	13	14
P1	D1	D2	D3	D4	D5	D6	D7	U1	U2	S1	S2	CR	LF

- **7-digit data format**

Consisting of 15 characters, including the end characters (CR= 0DH, LF= 0AH)

1	2	3	4	5	6	7	8	9	10	11	12	13	14	15
P1	D1	D2	D3	D4	D5	D6	D7	D8	U1	U2	S1	S2	CR	LF

- **8-digit data format**

Consisting of 16 characters, including the end characters (CR= 0DH, LF= 0AH)

1	2	3	4	5	6	7	8	9	10	11	12	13	14	15	16
P1	D1	D2	D3	D4	D5	D6	D7	D8	D9	U1	U2	S1	S2	CR	LF

Other data (date, time, etc.)

- **6-digit, 7-digit and 8-digit data format.**

The end characters (CR= 0DH, LF= 0AH) are attached to the message “M1, M2, ... Mn“

1	2	...	n	n+1	n+2
M1	M2	...	Mn	CR	LF

- **6-digit and 7-digit CSP data format**

Messages „M1, M2, ... MN“ are preceded by the device control code (DC2 = 12H); the end characters (CR= 0DH, LF= 0AH) and the device control code (DC4 = 14H) are appended to the messages

1	2	3	...	n+1	n+2	n+3	n+4
DC2	M1	M2	...	Mn	CR	LF	DC4

* **End characters:** CR = paragraph, LF = line

21.3.2 Data description

Presign:

P1 = 1 character

P1	Code	Significance
+	2BH	Data are 0 or positive
-	2DH	Data are negative

Numeric data:

D1-D7/D8/D9	Code	Significance
0 – 9	30H – 39H	Numbers 0 to 9 0 also used for zero padding
.	2EH	Decimal point (position not fixed)
Sp	20H	
/	2FH	Separator character inserted to the left of the non-verification-relevant digit

*Sp = space

Units:

U1, U2 = 2 characters: To indicate the unit of the numerical data

U1	U2	Code (U1)	Code (U2)	Significance	Symbol
Sp	G	20H	47H	Gram	g
K	G	4BH	47H	Kilogram	kg
C	T	43H	54H	Carat	ct

U1	U2	Code (U1)	Code (U2)	Significance	Symbol
M	O	4DH	4FH	Momme	(mom)
O	Z	4FH	5AH	Ounce	oz
L	B	4CH	42H	Pound	lb
O	T	4FH	54H	Troy ounce	ozt
D	W	44H	57H	Penny weight	dwt
T	L	54H	4CH	Tael Hongkong	tIH
T	L	54H	4CH	Singapur-Malaysia tael	tIS
T	L	54H	4CH	Taiwan tael	tIT
t	o	74H	6FH	Indian Tola	to
P	C	50H	43H	Quantity	PCS
Sp	%	20H	25H	Percent	%
Sp	#	20H	23H	Coefficient multiplication	#

*Sp = space

Result evaluation for weighing with tolerance range:

S1 = 1 character

S1	Code	Significance
L	4CH	Below lower tolerance limit (LOW)
G	47H	Within tolerance range (OK)
H	48H	Upper tolerance limit exceeded (HIGH)
Sp	20H	No evaluation result or data type specified
e	65H	Net weight
f	66H	Tare value
P	50H	PRE-TARE value
T	54H	Total
U	55H	Piece weight
d	64H	Gross

*Sp = space

Status of data:

S2 = 1 character

S2	Code	Significance
S	53H	Data stable
U	55H	Data not stable
E	45H	Data error, all data except S2 unreliable
Sp	20H	No special status

*Sp = space

21.4 Data output formats (CBM)

21.4.1 Data composition

Measurement results:

- **26-digit data format**

Consists of 26 characters, including the end characters (CR= 0DH, LF= 0AH)

1	2	3	4	5	6	7	8	9	10	11	12	13
S1	C1	Sp	T1	T2	T3	T4	T5	T6	D1	D2	D3	D4
14	15	16	17	18	19	20	21	22	23	24	25	26
D5	D6	D7	D8	D9	D10	D11	D12	U1	U2	Sp	CR	LF

*Sp = space

Error messages:

- **26-digit data format**

Consists of 26 characters, including the end characters (CR= 0DH, LF= 0AH)

1	2	3	4	5	6	7	8	9	10	11	12	13
*	*	Sp	E	R	R	O	R	Sp	*	*	*	*
14	15	16	17	18	19	20	21	22	23	24	25	26
*	*	*	*	*	*	*	*	*	*	Sp	CR	LF

*Sp = space

Other data (date, time, etc.)

- The end characters (CR= 0DH, LF= 0AH) are appended to the messages "M1, M2, ... Mn"

1	2	...	n	n+1	n+2
M1	M2	...	Mn	CR	LF

21.4.2 Data description

Status of data:

S1 = 1 character

S1	Code	Significance
Sp	20H	Data stable
*	2AH	Data not stable

*Sp = space

Result of the tolerance range weighing:

C1 = 1 character

C1	Code	Significance
Sp	20H	Within tolerance range (OK)
H	48H	Upper tolerance limit exceeded (HIGH)
L	4CH	Below lower tolerance limit (LOW)

*Sp = space

Data type:

T1 – T6 = 1 - 6 characters

T1	T2	T3	T4	T5	T6	Code						Significance
						T1	T2	T3	T4	T5	T6	
Sp	Sp	Sp	Sp	Sp	Sp	20H	20H	20H	20H	20H	20H	Net weight <41A STATUS>: <OFF>
N	Sp	Sp	Sp	Sp	Sp	4EH	20H	20H	20H	20H	20H	Net weight <41A STATUS>: <ON>
P	T	Sp	Sp	Sp	Sp	50H	54H	20H	20H	20H	20H	PRE-TARE value
T	Sp	Sp	Sp	Sp	Sp	54H	20H	20H	20H	20H	20H	Tare weight value
T	O	T	A	L	Sp	54H	4FH	54H	41H	4CH	20H	Total
G	Sp	Sp	Sp	Sp	Sp	47H	20H	20H	20H	20H	20H	Gross weight
U	N	I	T	Sp	Sp	55H	4EH	49H	54H	20H	20H	Piece weight

*Sp = space

Numeric data:

D1 – D12: 1 – 12 characters

D1 – D12	Code	Significance
+	2BH	Zero or positive values
-	2DH	Negative values
0 - 9	30H – 39H	Numbers 0 to 9 0 also used for zero padding
.	2EH	Decimal point

D1 – D12	Code	Significance
[5BH	Number between brackets ” [“ and “] “ marks the non-verification-relevant digit
]	5DH	
Sp	20H	Blanks fill the upper part of the data Output to the least significant digit if no decimal point is present Unused most significant digit

*Sp = space

Units:

U1, U2 = 2 characters

U1	U2	Code (U1)	Code (U2)	Significance
Sp	g	20H	67H	Gram
k	g	6BH	67H	Kilogram
c	t	63H	74H	Carat
m	o	6DH	6FH	Momme
o	z	6FH	7AH	Ounce
l	b	6CH	62H	Pound
O	T	4FH	54H	Troy ounce
d	w	64H	77H	Penny weight
t	l	74H	6CH	Tael Hongkong
t	l	74H	6CH	Singapur-Malaysia tael
t	l	74H	6CH	Taiwan tael
t	o	74H	6FH	Indian Tola
P	C	50H	43H	Quantity
Sp	%	20H	25H	Percent
Sp	#	20H	23H	Coefficient multiplication

*Sp = space

* **End characters:** CR = paragraph, LF = line

21.5 Data input



- Data entries cannot be processed by the scale if it is performing an action during the entry (e.g. making settings, zeroing, taring)
- Data can only be entered via the bidirectional RS232C interface (see chapter 21.1).
- When entering data, pay attention to upper-case and lower-case letters

Replies:

A00/Exx Format	Response	ACK/NAK Format
A00: Normal answer E01: Incorrect answer		ACK: Normal answer NAK: Incorrect answer

21.5.1 Input format 1

Input format:

1	2	3	4
C1	C2	CR	LF

Example of permanent output input:

⇒ Input: O0

Zeroing / taring, data output:

C1	C2	Code (C1)	Code (C2)	Significance
T	Sp	54H	20H	Set to zero/taring
Z	Sp	5AH	20H	Zeroing
O	0	4FH	30H	End output
O	1	4FH	31H	Permanent output
O	2	4FH	32H	Continuous output only for stable values (interruption of output for unstable values).
O	3	4FH	33H	Press [PRINT] key for one-time output
O	4	4FH	34H	Automatic output when weighing plate is loaded again and value is stable
O	5	4FH	35H	One-time output whenever value is stable (no output for unstable values)
O	6	4FH	36H	Continuous output for unstable values (interruption of output when value is stable → stable value is output once)
O	7	4FH	37H	Press [PRINT] key for one-time output at stable values (No output at unstable values)
O	8	4FH	38H	Single output
O	9	4FH	39H	One-time output at stable value
O	A	4FH	41H	Interval output
O	B	4FH	42H	Interval output for stable values

*Sp = space



- Commands O8 and O9 are used to request data.
- After entering O8 or O9, the scale returns O0.
- Commands O0 to O7 are executed after activation until the scale is turned off. When the **[MENU]** key is pressed or the scale is turned on again, the output settings **<413 CONDITION>** are reset.
- When OA or OB is entered, the interval output starts. The interval output stops when these commands are re-entered.

Date and time:

C1	C2	Code (C1)	Code (C2)	Significance
D	D	44H	44H	Output date
D	T	44H	54H	Output time

Adjustment / Adjustment test:

C1	C2	Code (C1)	Code (C2)	Significance
C	1	43H	31H	Perform internal semi-automatic adjustment
C	2	43H	32H	Perform internal adjustment test
C	3	43H	33H	Perform external adjustment
C	4	43H	34H	Perform external adjustment test

Response	
A00/Exx Format	ACK/NAK Format
A00: Normal answer E01: Incorrect answer	ACK: Normal answer NAK: Incorrect answer



Commands C3 and C4 are only available for the **FES** weighing system.

21.5.2 Input format 2

Input format:

1	2	3	4	5	6	7	8	9	10	11	12	13	14	15
C1	C2	,	C3	C3	C3	C3	C3	C3	C3	C3	C3	C3	CR	LF

Example for entering an upper tolerance limit (upper limit = 120 g):

⇒ Input: LB,120.0

Example for entering a time for interval output (output every 12 hours, 34 minutes, and 56 seconds):

⇒ Input: IA,12,34,56 (delimitation by commas).



- C3 can contain a maximum of 10 numeric characters (including polarity +/-, comma and dot).
- Be careful not to enter any weighing units (e.g.,).
- Entries are only accepted by the scale if it is in a weighing application (simple weighing, piece counting, percentage weighing, coefficient multiplication). If the scale is not in a weighing application, an incorrect response will be shown.
- If invalid entries are made, the scale responds with an incorrect answer.
- Observe the readability of the scale when entering tolerance values or PRE-TARE values, The entry will not be accepted if the value entered exceeds the readability range.

Set tolerance values:

C1	C2	Code (C1)	Code (C2)	Significance	C3
L	A	4CH	41H	Set lower tolerance limit	Numeric value
L	B	4CH	42H	Set upper tolerance limit	Numeric value
L	C	4CH	43H	Set reference value	Numeric value

PRE-TARE value:

C1	C2	Code (C1)	Code (C2)	Significance	C3
P	T	50H	54H	Set PRE-TARE value	Numeric value



- For normal responses, the PRE-TARE value is stored in <321 PRESET 1> and executed by the scale.
- If a PRE-TARE value of 0 is entered, PRE-TARE is aborted

Time setting of the interval output:

C1	C2	Code (C1)	Code (C2)	Significance	C3
I	A	49H	41H	Set time of interval output (hh,mm,ss).	Numeric value

21.6 Response formats

21.6.1 A00/Exx Format

Consisting of 5 characters, including the end characters (CR= 0DH, LF= 0AH)*.

1	2	3	4	5
A1	A2	A3	CR	LF

* **End characters:** CR = paragraph, LF = line

Commands:

A1	A2	A3	Code (A1)	Code (A2)	Code (A3)	Significance
A	0	0	41H	30H	30H	Normal answer
E	0	1	45H	30H	31H	Incorrect answer

21.6.2 ACK/NAK Format

Consists of one character (without end characters).

1
A1

Commands:

A1	Code (A1)	Significance
ACK	06H	Normal answer
NAK	15H	Incorrect answer

21.7 Communication settings

Settings on the balance can be made via the menu by pressing the **[MENU]** key.



For navigation in the menu see chapter 8.2

21.7.1 Activate / deactivate the RS232-C interface

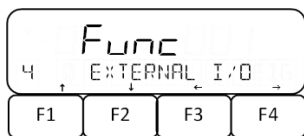

⇒ Navigate to **<4 EXTERNAL I/O>** using the keys **[F1]** and **[F2]** keys.

⇒ Press **[F4]** key to access the settings

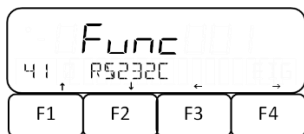

⇒ Navigate to **<41 RS232C>** using the **[F1]** and **[F2]** keys.

⇒ Press **[F4]** key to access the settings



⇒ Navigate to **<411 ACTIVATE>** using the keys **[F1]** and **[F2]**.

⇒ Press **[F4]** key to make settings

⇒ Use keys **[F1]** and **[F2]** to select the desired setting:

OFF	Disabled
ON	Enabled

⇒ Press **[F4]** key to confirm selection.

21.7.2 Adjust communication settings

All settings are made in **<41 RS232C>** (see chapter 21.7.1).

Set the format:



The CSP data output formats are only available for the **FES** weighing system.

- ⇒ Navigate to **<412 FORMAT>** using the **[F1]** and **[F2]** keys.
- ⇒ Press **[F4]** key to make settings
- ⇒ Use **[F1]** and **[F2]** to select the desired setting:

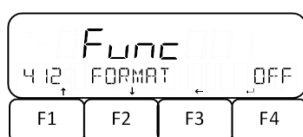

- 6 | 6-digit numeric format
- 7 | 7-digit numeric format
- 8 | 8-digit numeric format
- CSP6 | CSP format with 6 digits
- CSP7 | CSP format with 7 digits
- CBM | CBM-format

- ⇒ Press **[F4]** key to confirm selection.

Set output condition:



Settings 1, 3 and 6 are not available for the **FEJ** weighing system.

- ⇒ Navigate to **<413 CONDITION>** using the **[F1]** and **[F2]** keys.
- ⇒ Press **[F4]** key to make settings
- ⇒ Use **[F1]** and **[F2]** to select the desired setting:

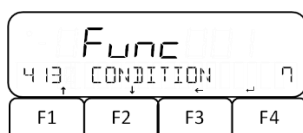

- OFF | End output
- 1 | Permanent output
- 2 | Continuous output only for stable values (interruption of output for unstable values).
- 3 | One-time output when **[PRINT]** key is pressed
- 4 | Automatic output (One-time output when the value is stable. The next output for another sample occurs when the reading is stabilized to less than or equal to zero by unloading, zero adjustment or tare subtraction).

- 5 | One-time output whenever value is stable (no output for unstable values)
- 6 | Continuous output for unstable values (interruption of output when value is stable → stable value is output once)
- 7 | Press **[PRINT]** key for one-time output at stable values (No output at unstable values)

⇒ Press **[F4]** key to confirm selection.

Output when weighing with tolerance range:

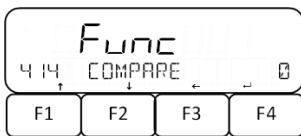

- ⇒ Navigate to **<414 COMPARE>** with the **[F1]** and **[F2]** keys.
- ⇒ Press **[F4]** key to make settings
- ⇒ Use **[F1]** and **[F2]** to select the desired setting:

- 0 | Output according to output settings
- 1 | Output when value is within tolerance range

⇒ Press **[F4]** key to confirm selection.

Set baud rate:

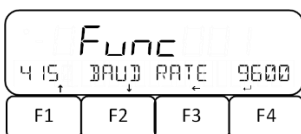

- ⇒ Navigate to **<415 BAUD RATE>** using the **[F1]** and **[F2]** keys.
- ⇒ Press **[F4]** key to make settings
- ⇒ Use **[F1]** and **[F2]** to select the desired setting:

- 1200 | 1200 bps
- 2400 | 2400 bps
- 4800 | 4800 bps
- 9600 | 9600 bps
- 19200 | 19200 bps
- 38400 | 38400 bps
- 57600 | 57600 bps
- 115.2k | 115200 bps

⇒ Press **[F4]** key to confirm selection.

Set parity:

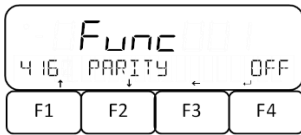

- ⇒ Navigate to **<416 PARITY>** using the keys **[F1]** and **[F2]**.
- ⇒ Press **[F4]** key to make settings
- ⇒ Use keys **[F1]** and **[F2]** to select the desired setting:

OFF		Empty
ODD		Odd
EVEN		Even
- ⇒ Press **[F4]** key to confirm selection.

Set stop bit:

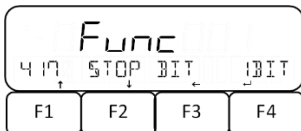

- ⇒ Navigate to **<417 STOP BIT>** using the keys **[F1]** and **[F2]**.
- ⇒ Press **[F4]** key to make settings
- ⇒ Use keys **[F1]** and **[F2]** to select the desired setting:

1BIT		1 bit
2BIT		2 bit
- ⇒ Press **[F4]** key to confirm selection.

Set handling of blank digits:

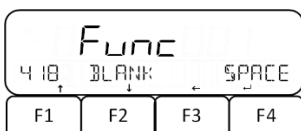

- ⇒ Navigate to **<418 BLANK>** using the keys **[F1]** and **[F2]**.
- ⇒ Press **[F4]** key to make settings
- ⇒ Use keys **[F1]** and **[F2]** to select the desired setting:

ZERO		Fill with 0 (30H)
SPACE		Fill with blank line (20H)
- ⇒ Press **[F4]** key to confirm selection.

Set response format:

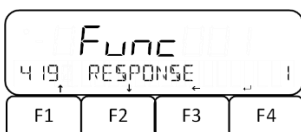

- ⇒ Navigate to **<419 RESPONSE>** using the keys **[F1]** and **[F2]**.
- ⇒ Press **[F4]** key to make settings
- ⇒ Use keys **[F1]** and **[F2]** to select the desired setting:

1		Format: A00/Exx
2		Format: ACK/NAK

⇒ Press **[F4]** key to confirm selection.

Set display of net values:



The display of net values is only available for the **FES** weighing system.

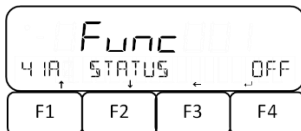

⇒ Use the keys **[F1]** and **[F2]** to navigate to **<41A STATUS>**.

⇒ Press **[F4]** key to make settings

⇒ Use keys **[F1]** and **[F2]** to select the desired setting:

OFF		Do not show the note „Netto“
ON		Show the note „Netto“

⇒ Press **[F4]** key to confirm selection.

Set the display of the time stamp:

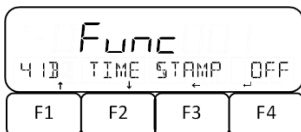

⇒ Navigate to **<41B TIME STAMP>** using the keys **[F1]** and **[F2]**.

⇒ Press **[F4]** key to make settings

⇒ Use keys **[F1]** and **[F2]** to select the desired setting:

OFF		Do not display timestamp
ON		Display timestamp

⇒ Press **[F4]** key to confirm selection.

22 Servicing, maintenance, disposal



Before any maintenance, cleaning and repair work disconnect the appliance from the operating voltage.

22.1 Cleaning

- ⇒ Comply with IP protection
- ⇒ Please do not use aggressive cleaning agents (solvents or similar agents), but a cloth dampened with mild soap suds.
- ⇒ Wipe with a dry, soft cloth.
- ⇒ Do not use cleaning agents that contain caustic soda, acetic acid, hydrochloric acid, sulphuric acid or citric acid on stainless steel parts.
- ⇒ Clean stainless-steel parts with a soft cloth soaked in a cleaning agent suitable for stainless steel.
- ⇒ Make sure that no liquid enters the instrument.
- ⇒ Do not use metal brushes or cleaning sponges of steel wool, as this causes superficial corrosion.
- ⇒ Loose sample residues/powder can be removed carefully with a brush or hand-held vacuum cleaner.
- ⇒ Remove spilled weighed material immediately

22.2 Servicing, maintenance

- ⇒ The unit may only be opened by qualified service technicians authorised by KERN.
- ⇒ Before opening, disconnect from power supply.

22.3 Disposal

Disposal of packaging and appliance must be carried out by operator according to valid national or regional law of the location where the appliance is used.

23 Instant help for troubleshooting

In the event of a fault in the programme sequence, the scale should be briefly switched off and disconnected from the mains. The weighing process must then be restarted.

Fault	Possible cause
The weight display does not glow	<ul style="list-style-type: none">• The balance is not switched on• The mains supply connection has been interrupted (mains cable not plugged in/faulty).• Power supply interrupted.• (Rechargeable) batteries are inserted incorrectly or empty• No (rechargeable) batteries inserted
The displayed weight is permanently changing	<ul style="list-style-type: none">• Draught/air movement• Table/floor vibrations• Weighing plate has contact with other objects• Electromagnetic fields / static charging (choose different location/switch off interfering device if possible)
The weighing result is obviously incorrect	<ul style="list-style-type: none">• The display of the balance is not at zero• Adjustment is no longer correct• The balance is on an uneven surface• Great fluctuations in temperature• Electromagnetic fields / static charging (choose different location/switch off interfering device if possible)

Should other error messages occur, switch balance off and then on again. If the error message remains inform manufacturer.

23.1 Error messages

Error message	Description	Possible causes / repair
OVER ERROR	<ul style="list-style-type: none"> Maximum weighing range exceeded The total exceeds the maximum number of characters on the display 	<ul style="list-style-type: none"> Split sample and weigh individually Use lighter tare weight Delete the result of the calculation and perform the calculation again (pay attention to the display)
UNDER ERROR	<ul style="list-style-type: none"> Negative load is below the minimum weighing range 	<ul style="list-style-type: none"> Weighing plate or weighing plate carrier incorrectly adjusted Check whether the scale is touching other objects Only use the intended weighing plate and weighing plate carrier
DISPLAY ERROR	<ul style="list-style-type: none"> The total exceeds the maximum number of characters on the display 	<ul style="list-style-type: none"> Delete the result of the calculation and perform the calculation again (pay attention to the display)
LOWER ERROR	<ul style="list-style-type: none"> The piece/reference weight in counting/per cent mode is below the minimum weighing range 	<ul style="list-style-type: none"> Select samples whose piece/reference weight is above the minimum weighing range
ERR001 to ERR099	<ul style="list-style-type: none"> System error 	<ul style="list-style-type: none"> Note error code and notify dealer
ERR703	<ul style="list-style-type: none"> A key was pressed during power-up If no key was pressed, there may be a hardware fault. 	<ul style="list-style-type: none"> No key pressed while the scale is performing the power-up procedure
ERR705	<ul style="list-style-type: none"> Initial zeroing error during power-up due to unstable load 	<ul style="list-style-type: none"> Weighing plate or weighing plate carrier incorrectly adjusted Check whether the scale is touching other objects Check for vibrations or draughts
ERR706	<ul style="list-style-type: none"> Load is outside the initial zeroing range 	<ul style="list-style-type: none"> Do not load the scale during power up
ERR709 ERR710 ERR711	<ul style="list-style-type: none"> Unstable weight value during zeroing or taring Timeout during adjustment 	<ul style="list-style-type: none"> Weighing plate or weighing plate carrier incorrectly adjusted Check whether the scale is

		<p>touching other objects</p> <ul style="list-style-type: none"> • Check for vibrations or draughts
ERR717	<p>The mass of the external adjustment weight deviates by more than 1 % from</p> <ul style="list-style-type: none"> • the intended adjustment weight • the maximum capacity during the adjustment test 	<ul style="list-style-type: none"> • Check and use the intended weight value of the external adjustment weight.
ERR718	<p>The mass of the adjustment weight is less than 50% of the maximum capacity during adjustment or adjustment of the internal weight with an external weight</p>	<ul style="list-style-type: none"> • Use a adjustment weight with a weight value equal to the maximum capacity of the scale.
ERR719	<p>The set value at adjustment exceeds the maximum capacity by 1%.</p>	<ul style="list-style-type: none"> • Perform <637 REF CAL RESTORE>, then perform <636 REF CAL>. • Check adjustment weight with an external weight
ERR722	<ul style="list-style-type: none"> • [TARE] key was pressed during PRE-TARE procedure 	<ul style="list-style-type: none"> • Do not press the [TARE] key during PRE-TARE.
ERR723	<ul style="list-style-type: none"> • Zeroing range exceeded (1.5 % of the maximum weighing range) 	<ul style="list-style-type: none"> • Unload the weighing plate before zeroing.
ERR724	<ul style="list-style-type: none"> • Tare range exceeded (0 g of the maximum weighing range) 	<ul style="list-style-type: none"> • Select tare weight that is within tare range
ERR734	<ul style="list-style-type: none"> • Weight of the weighed material is outside the import range when using the actual value setting method in percentage weighing mode (lower limit to maximum load) 	<ul style="list-style-type: none"> • Use material to be weighed whose weight is within the import range
ERR735	<ul style="list-style-type: none"> • Timeout during import of current weight value with actual value setting method in percentage weighing mode 	<ul style="list-style-type: none"> • Weighing plate or weighing plate carrier incorrectly adjusted • Check whether the scale is touching other objects • Check for vibrations or draughts
ERR736	<ul style="list-style-type: none"> • The set value is outside the setting range during numeric entry in the percentage weighing mode (lower limit to maximum load) 	<ul style="list-style-type: none"> • Set value within range
ERR739	<ul style="list-style-type: none"> • Timeout during sample weight import in actual value setting method in PRE-TARE setting mode 	<ul style="list-style-type: none"> • Weighing plate or weighing plate carrier incorrectly adjusted • Check whether the scale is

		<ul style="list-style-type: none"> touching other objects • Check for vibrations or draughts
ERR740	<ul style="list-style-type: none"> • Set value is out of range in numeric entry or actual value setting method in PRE-TARE setting (0 g to maximum load). 	<ul style="list-style-type: none"> • Set the tare within the tare subtraction range.
ERR741	<ul style="list-style-type: none"> • <631 EX CAL> is executed while external adjustment is disabled 	<ul style="list-style-type: none"> • Contact dealer
ERR742	<ul style="list-style-type: none"> • Internal adjustment is not working 	<ul style="list-style-type: none"> • Contact dealer
ERR743	<ul style="list-style-type: none"> • Battery is too low to perform <633 INT CAL>, <634 INT SPAN TEST> or <636 REF CAL> (For scales with rechargeable battery). 	<ul style="list-style-type: none"> • Charge rechargeable battery • Operate scale with AC adapter
ERR746	<ul style="list-style-type: none"> • Incorrect date or time entered at <647 DATE SETTING> or <648 TIME SETTING>. 	<ul style="list-style-type: none"> • Set date and time correctly
ERR747	<ul style="list-style-type: none"> • Timeout during import of sample weight in actual value setting method in tolerance weighing mode. 	<ul style="list-style-type: none"> • Weighing plate or weighing plate carrier incorrectly adjusted • Check whether the scale is touching other objects • Check for vibrations or draughts
ERR748	<ul style="list-style-type: none"> • The set value in the actual value setting method or numeric entry exceeds the permissible setting range in the tolerance weighing mode ("0 - maximum capacity" to "maximum capacity") 	<ul style="list-style-type: none"> • Set value within the permissible range
ERR749	<ul style="list-style-type: none"> • Timeout while importing sample weight in actual value setting method in totalizing function 	<ul style="list-style-type: none"> • Weighing plate or weighing plate carrier incorrectly adjusted • Check whether the scale is touching other objects • Check for vibrations or draughts
ERR750	<ul style="list-style-type: none"> • The weight of the sample to be added is outside the import range ("0 - maximum capacity" to "maximum capacity") • The total sum exceeds the maximum number of characters on the display 	<ul style="list-style-type: none"> • Select sample whose weight is within the import range • Clear total sum

ERR751	<ul style="list-style-type: none"> Unit weight of samples is less than the smallest unit weight 	<ul style="list-style-type: none"> Use samples whose unit weight is greater than the smallest unit weight
ERR752	<ul style="list-style-type: none"> Piece weight of samples is too low (0 g or less) during piece counting mode 	<ul style="list-style-type: none"> Use samples whose unit weight is greater than the smallest unit weight
ERR753	<ul style="list-style-type: none"> Timeout during import of piece weight in piece counting mode 	<ul style="list-style-type: none"> Weighing plate or weighing plate carrier incorrectly adjusted Check whether the scale is touching other objects Check for vibrations or draughts
ERR760	<ul style="list-style-type: none"> Attempt to perform totalizing operation even though totalizing function is disabled 	<ul style="list-style-type: none"> Set <141 ACTIVATE> to ON to use the totalizing function.
ERR761	<ul style="list-style-type: none"> Error at <636 REF CAL> 	<ul style="list-style-type: none"> Carry out <636 REF CAL> again
ERR764	<ul style="list-style-type: none"> External weight for <631 EX CAL> is different from the weight range set in <SELECT WEIGHT>. 	<ul style="list-style-type: none"> Use external weight whose weight value is in the set range